

# SAN FRANCISCO, SAN PABLO AND SUISUN BAYS HARBOR SAFETY PLAN

Voted on by the  
Harbor Safety Committee of the San Francisco Bay Region  
June 9, 2016

**H**arbor  
**S**afety  
**C**ommittee  
**of the San Francisco Bay Region**

*Mandated by the California Oil Spill  
Prevention and Response Act of 1990*

Pursuant to the  
California Oil Spill and Prevention Act of 1990

Submitted by the  
Harbor Safety Committee of the San Francisco Bay Region  
c/o Marine Exchange of the San Francisco Bay Region  
505 Beach Street, Suite 300  
San Francisco, California 94133-1131  
Telephone: (415) 441-7988  
[hsc@sfx.org](mailto:hsc@sfx.org)

## Table of Contents

<u>Introduction.....</u>	<u>iii</u>
<u>Harbor Safety Committee Organization.....</u>	<u>v</u>
<u>Executive Summary.....</u>	<u>viii</u>
<u>I. Geographic Boundaries.....</u>	<u>1</u>
<u>II. General Weather, Currents and Tides.....</u>	<u>3</u>
<u>III. Aids to Navigation.....</u>	<u>18</u>
<u>IV. Anchorages.....</u>	<u>19</u>
<u>V. Surveys, Charts and Dredging.....</u>	<u>23</u>
<u>VI. Contingency Routing.....</u>	<u>27</u>
<u>VII. Vessel Speed and Traffic Patterns.....</u>	<u>29</u>
<u>VIII. Accidents and Near-Accidents.....</u>	<u>33</u>
<u>IX. Communication.....</u>	<u>35</u>
<u>X. Bridges.....</u>	<u>38</u>
<u>XI. Small Passenger Vessels – Ferries.....</u>	<u>41</u>
<u>XII. Small Vessels.....</u>	<u>46</u>
<u>XIII. Vessel Traffic Service.....</u>	<u>49</u>
<u>XIV. Tug Escort / Assist for Tank Vessels.....</u>	<u>55</u>
<u>XV. Pilotage.....</u>	<u>60</u>
<u>XVI. Underkeel Clearance.....</u>	<u>61</u>
<u>XVII. Economic and Environmental Impacts.....</u>	<u>62</u>
<u>XVIII. Plan Enforcement.....</u>	<u>65</u>
<u>XIX. Recommendations Implemented or Addressed.....</u>	<u>66</u>
<u>XX. Harbor Safety Committee Educational Materials.....</u>	<u>73</u>
<u>Table of Appendices.....</u>	<u>ii</u>
<u>Table of Maps.....</u>	<u>ii</u>

## **Table of Appendices**

<a href="#"><u>Appendix A: Best Maritime Practices</u></a> .....	74
<a href="#"><u>Appendix B: Bylaws of the Harbor Safety Committee of the San Francisco Bay Region</u></a> .....	177
<a href="#"><u>Appendix C: Annual Work Group Reports</u></a> .....	185
<a href="#"><u>Appendix D: Tug Escort Regulations and OSPR Escort Recap</u></a> .....	194
<a href="#"><u>Appendix E: Clearing House List of Certified Tug Escort Boats</u></a> .....	221
<a href="#"><u>Appendix F: Clearing House Report on Escorted Vessel Movements</u></a> .....	224
<a href="#"><u>Appendix G: Clearing House List of Tanker Movements and Total Vessel Movements in San Francisco Bay</u></a> .....	229
<a href="#"><u>Appendix H: Recommendations for Conducting Escort Training On San Francisco Bay</u></a> .....	240
<a href="#"><u>Appendix I: Sites of the Physical Oceanographic Real Time System (PORTS) Instruments That Measure Currents, Tides, Meteorological Data And Salinity</u></a> .....	243
<a href="#"><u>Appendix J: Vehicular Bridge Inventory</u></a> .....	244
<a href="#"><u>Appendix K: Coast Guard Marine Safety Office Bay Port Safety Statistics</u></a> ...	247
<a href="#"><u>Appendix L: Coast Guard Marine Safety Office Bay Pollution Statistics</u></a> .....	254
<a href="#"><u>Appendix M: SLC-MFD Waterborne Petroleum Cargo Statistics</u></a> .....	263
<a href="#"><u>Appendix N: Recommendations to Be Addressed</u></a> .....	264

## **Table of Maps**

<a href="#"><u>Map 1</u></a> <a href="#"><u>Geographic Limits of the Harbor Safety Plan</u></a> .....	267
<a href="#"><u>Map 2</u></a> <a href="#"><u>Vessel Traffic System San Francisco Service Area</u></a> .....	268
<a href="#"><u>Map 3</u></a> <a href="#"><u>Tug Escort Zones</u></a> .....	269

## Introduction

*In 1990, the California Legislature enacted the Oil Spill Prevention and Response Act (OSPRA). The goals of OSPRA are to improve the prevention, removal, abatement, response, containment and cleanup and mitigation of oil spills in the marine waters of California. The Act (SB 2040) created harbor safety committees for the major harbors of the state of California to plan “for the safe navigation and operation of tankers, barges, and other vessels within each harbor ... [by preparing] ... a harbor safety plan, encompassing all vessel traffic within the harbor.” The Harbor Safety Committee of the San Francisco Bay Region was officially sworn in September 18, 1991 and held its first meeting on that date. The original Harbor Safety Plan for San Francisco, San Pablo and Suisun Bays was adopted August 13, 1992. SB 2040 mandates that the Harbor Safety Committee must annually review its previously adopted Harbor Safety Plan and recommendations and submit the annual review to the OSPR Administrator for comment.*

*The full committee of the Harbor Safety Committee holds regular monthly public meetings. The committee chairperson may appoint work groups to review the mandated components of the Harbor Safety Plan and timely issues. All committee and work group meetings are noticed to the public. Public comments are received throughout discussions of the various issues, which results in full public participation in developing the recommendations of the Harbor Safety Plan of the San Francisco Bay Region.*

*The San Francisco Bay Harbor Safety Plan encompasses a series of connecting bays, including the San Francisco, San Pablo and Suisun Bays, and the Sacramento River to the Port of Sacramento and the San Joaquin River to the Port of Stockton. The distance from the San Francisco lighted horn buoy outside the Bay to the Ports of Stockton and Sacramento is approximately one hundred miles. The 548-square-mile Bay has an irregular 1,000 mile shoreline composed of a variety of urban and suburban areas, marshes and salt ponds. Several significant islands are located within the Bay, including Angel Island, Alcatraz Island, Yerba Buena Island and Treasure Island. Map 1 depicts the geographic boundaries of the area covered by the Harbor Safety Plan.*

*The San Francisco Bay system is the largest estuary on the Pacific Coasts of North and South America. Waters from the two major river systems and the Bay flow through the Golden Gate, which is less than a mile wide at its narrowest point. Because of the volume of water moving through the narrow opening on a daily basis, tides and strong currents occur in the Bay. While the Bay is extremely deep (356 feet) under the Golden Gate Bridge because of the swiftly moving volume of water, the Bay is very shallow in many areas and subject to sedimentation from the rivers emptying into the Bay. Sediment also is deposited outside the entrance to San Francisco Bay where a semicircular bar extends into the Pacific Ocean. The Bay itself is less than 18 feet deep over two-thirds of its area, and the Bay bottom is predominantly mud. A dredged Main Ship Channel allows deep-draft vessels to navigate the Bay.*

*The Bay presents a number of hazards to navigation, such as strong tides and currents and variable bottom depths, which confine large vessels to defined shipping lanes within the Bay. Navigating the Bay becomes more complex during periods of restricted visibility. The San Francisco Bar Pilots regularly compile recommended guidelines for safe navigation entitled “Port Safety Guidelines for Movement of Vessels on San Francisco Bay and Tributaries.” The guidelines are sent to members of the shipping industry, and are based on a general consensus among pilots as to recommended navigation practices.*

*The Bay supports a variety of uses, including shipping, fishing, ferry transit and various recreational activities. There are seven ports, a number of marine terminals, and military facilities at the Military Ocean Terminal Concord (MOTCO) and Moffet Field. Because the water depths near refineries in Contra Costa and Solano Counties cannot safely accommodate larger oil tankers, large tankers lighter oil to smaller tankers or barges to move cargo in-Bay to marine terminals. Map 3 identifies the location of marine terminals in the plan area. In addition, an expanding ferry system annually makes over 85,000 (2004) trips, mainly to and from San Francisco in the central part of the Bay. Because much of the Bay shoreline is urbanized, recreational boating and the growing sports of board sailing and paddle sports are popular, with an estimated 20,000 boat berths around the Bay, exclusive of the Sacramento and San Joaquin Rivers, as well as numerous boat launch sites.*

*The shipping industry is a particularly vital part of the Bay Area economy. Shipping spokespersons estimate that approximately 100,000 jobs are dependent upon the shipping industry and that the industry contributes nearly \$5 billion to the regional economy.*

*Thus, vessel traffic in the Bay consists of a complex variety of inbound and outbound vessels, wholly in-Bay vessel movements, tugs, government vessels, ferries, recreational boats, commercial and sports fishing boats, board sailors, paddle sports enthusiasts and personal watercraft (jet skis) within the series of bays, channels and rivers that comprise the San Francisco Bay planning area.*

## Organization of the Harbor Safety Committee of the San Francisco Bay Region

The San Francisco Harbor Safety Committee consists of representatives from the following: ports (four), dry cargo vessel operators (two), tank ship operators (two) or one ship operator and one oil marine terminal operator, and one tug operator, one tank barge operator, a passenger ferry or excursion vessel operator, the regional pilot organization, a vessel labor union, a commercial fishing representative, a recreational boater, an environmental organization, the U.S. Coast Guard Captain of the Port, the U.S. Army Corps of Engineers, the National Oceanic and Atmospheric Administration and the San Francisco Bay Conservation and Development Commission. A complete list of committee members is found in Appendix B.

Chair.....Captain Lynn Korwatch  
Marine Exchange of the San Francisco Bay  
Region  
505 Beach Street, Suite 300  
San Francisco, California 94133  
Ph: (415) 441-5045 Fax: (415) 441-1025  
korwatch@sfmtx.org

Vice Chair .....John Berge  
Pacific Merchant Shipping Association  
70 Washington Street, Suite 305  
Oakland, California  
Ph: (510) 987-5000 Fax: (510) 584-9565  
jberge@pmsaship.com

Executive Secretary .....Captain Lynn Korwatch  
Marine Exchange of the San Francisco Bay  
Region  
505 Beach Street, Suite 300  
San Francisco, California 94133  
Ph: (415) 441-5045 Fax: (415) 441-1025  
korwatch@sfmtx.org

## Harbor Safety Committee Work Groups

- Dredging ..... Griffin Patrick, Co-Chair  
Tesoro Refining and Marketing Affairs  
150 Solano Way  
Martinez, California 94553  
Phone: (925) 372-3015  
griffin.d.patrick@tsocorp.com
- Chad Culbertson, Co-Chair  
Chevron Shipping Co. LLC  
841 Chevron Way  
Richmond, California 94802  
Phone: (510) 242-4630  
Chad.Culbertson@chevron.com
- Ferry Operations ..... Tom Dougherty, Chair  
Blue & Gold Fleet  
Pier 41 Marine Terminal  
San Francisco, California 94133  
Ph: 415.705-8200 Fax: 415.705-5429  
tfdoughertysfo@gmail.com
- Navigation..... Robert Carr, Chair  
San Francisco Bar Pilots  
Pier 9, East End  
San Francisco, California 94111  
Ph: 203.512-7138  
r.carr@sfbarpilots.com
- PORTS ..... Chris Peterson, Chair  
Port of Oakland  
530 Water Street  
Oakland, California 94607  
Phone: (510) 627-1308 Fax: (510) 763-8287  
cpeterson@portoakland.com
- Prevention through People ..... Margot Brown, Chair  
National Boating Federation  
3217 Fiji Lane  
Alameda, California 94501  
Ph: 510.523-2098 Fax: 510.523-2098  
mjbjhb@aol.com

Tugs.....Bob Gregory, Chair  
Foss Maritime Co.  
1316 Canal Blvd.  
Richmond, California 94804  
Ph: 510.301-7825 Fax: 510.307-7821  
bob@foss.com

For a list of all Committee members, see:

<http://www.sfm.org/support/hsc/hscmembers.php>

To review the regulations governing the Harbor Safety Committee, see:

<https://nrm.dfg.ca.gov/FileHandler.ashx?DocumentID=21988&inline>

**Highlighted headings** in this Safety Plan indicate Best Maritime Practices (BMPs) that have been adopted by the SF Harbor Safety Committee. For a compilation of BMPs, please see Appendix A.



## **Executive Summary 2015/2016**

The Harbor Safety Committee continued its collaborative process to engage the maritime community in working to increase navigation safety in the Bay. The Dredging Work Group coordinated with USACE, SF Bar Pilots, and involved stakeholders prior to the start of dredging to ensure results in all navigation channels were beneficial to users. The Navigation Work Group worked with crab fisherman and USCG to remedy visual interference to large vessels created by boat working lights and discussed the need for timely radio communication. The Tug Work Group initiated an assessment of emergency towing capabilities in the HSC AOR, per SB 414.

Also during 2015-2016:

- The Dredging Work Group authored a letter to Senator Dianne Feinstein requesting her support for FY 2016 appropriations for dredging.
- The Ferry Operations Work Group presented ferry system operating reports and growth plans for discussion among HSC members and others.
- The Navigation Work Group worked with VTS to create berthing schemes for Anchorages 7 and 8.
- The Tug Work Group received approval from the OSPR Administrator to use the Tanker Escort Matrix for ATBs.

See Appendix C, Annual Work Group reports, for additional activities over the past year.

## I. Geographic Boundaries

The policies and recommendations contained in the San Francisco Bay Harbor Safety Plan address vessel safety in the marine waters of the San Francisco, San Pablo and Suisun Bays, up to and including the Ports of Sacramento and Stockton, which establish the eastern boundary of the plan area. The western boundary of the plan is inscribed by a circle with a radius of six nautical miles (nm) centered on San Francisco Approach Lighted Horn Buoy SF (37° 45. 0'N., 122° 41.5'W) and includes the Main Ship Channel to the COLREGS demarcation line (see map opposite). This includes the Offshore Vessel Movement Reporting System, Vessel Traffic Service and Traffic Separation schemes within the area. NOAA charts 18649-18663 cover the Harbor Safety Plan Area.

*(See map following page.)*

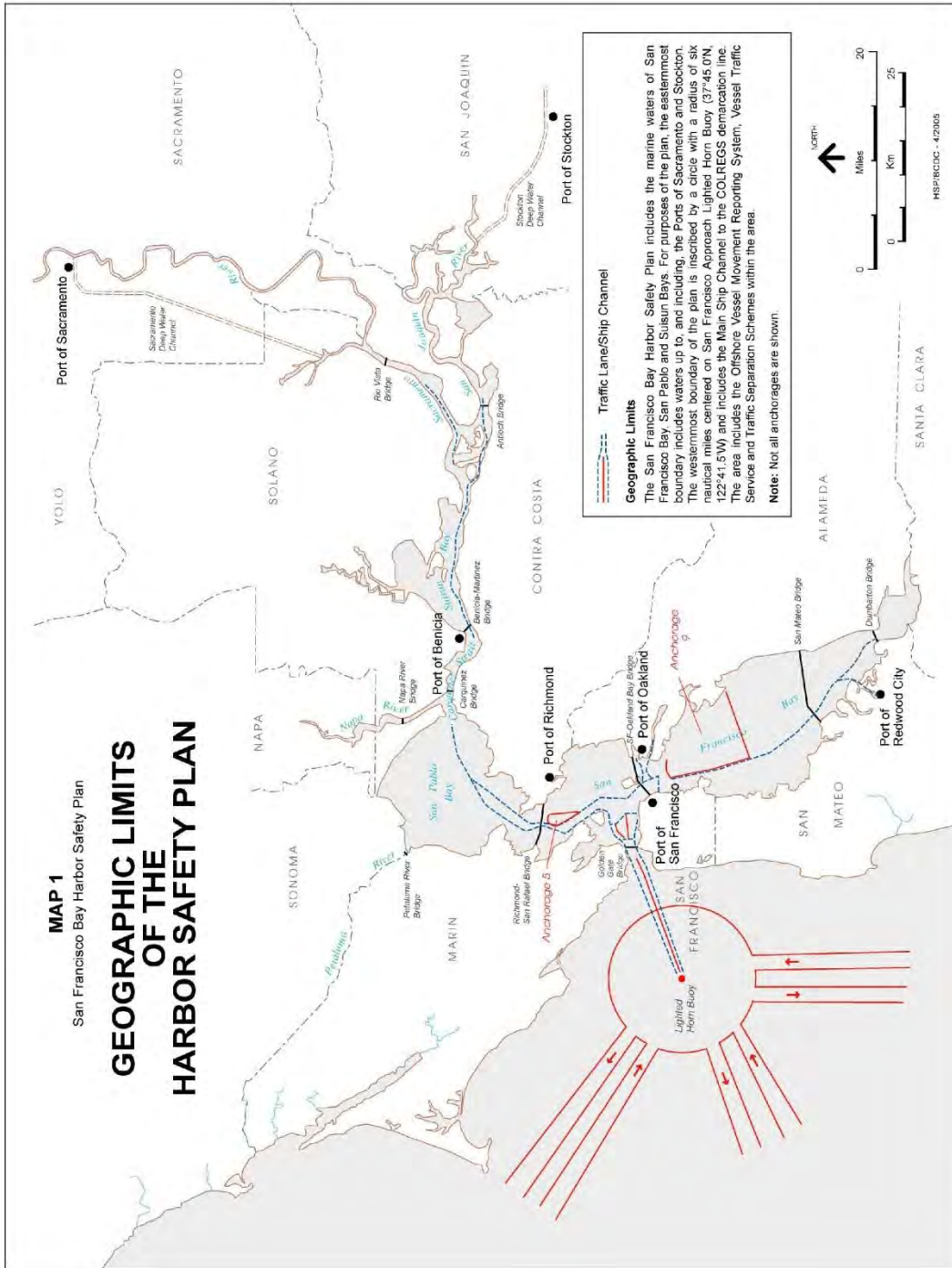

## II. General Weather, Currents and Tides

The majority of the background information presented here is derived from the National Weather Service and can be viewed in its entirety in the *U.S. Coast Pilot 7, Pacific Coast*, published by NOAA and available from the following website: <http://nauticalcharts.noaa.gov/nsd/cpdownload.htm>. The *Coast Pilot* information is augmented with observations from local sources.

Ships traveling into the Bay encounter diverse weather, currents, tides and bottom depths. Because of the often varied and changing set of harbor conditions, mariners must be observant about current conditions to navigate safely.

### Weather

Bay Area weather is seasonably variable with three discernible seasons affecting the marine environment. The Bay Area has several climate regimes, or microclimates. Significant differences in temperature, winds, and fog patterns over relatively short distances are due to variations in air mass between land and sea and to the complex terrain of the coastal mountain ranges. Wind direction is generally west to east; however, there is a great deal of variation due to the complex geography.

Because of the many microclimates of the San Francisco Bay Area, mariners who navigate the waters from outside the Golden Gate, through the San Francisco Bay and Delta and into the Central Valley must be aware of how weather conditions can change significantly over short distances and over short periods of time. Mariners must also be aware of the unique weather conditions and weather hazards that are most prevalent during each season.

### Winds

**Winter.** Winter is the season with the most significant seas, both in terms of locally driven wind waves as well as open ocean swells that are generated by long fetches of strong winds over the eastern Pacific. Winter winds from November to February shift frequently and have a wide range of speeds dependent on the procession of offshore high and low pressure systems. Calms occur 15 to 40 percent of the time inside the Bay and 10 to 12 percent outside. Extreme wind conditions of 50 knots gusting to 75 knots have occurred during the winter. The strongest winds tend to come from the Southeast to Southwest ahead of a cold front.

Seas are sometimes large enough to produce breakers across the San Francisco Bar, several miles west of the Golden Gate. These breaking waves in the open ocean present a significant danger to mariners, especially those unfamiliar with the area. Breakers across the bar are most common with a long period westerly swell around the time of maximum ebb current through the Golden Gate.

**Spring.** Spring is generally the windiest season, with average speeds in the Bay of 6-12 knots, with wind speeds of 17-28 knot winds up to 40 percent of the time. Wind speeds sometimes reach gale force over the coastal waters outside the Golden Gate, and approach gale force locally in northern San Francisco Bay. Wind direction stabilizes as the Pacific High Pressure System becomes the dominant weather influence. Northwesterly winds are generated and reinforced by the sea breeze. Inside the Bay, winds are channeled and vary from Northwest to Southwest.

Strong springtime winds over the coastal waters produce rough and choppy seas with a short period swell. The large long-period swells common during the winter months still roll through the coastal waters quite often during the early spring, but taper off considerably by late spring as the storm track across the Pacific becomes less active.

**Summer.** Summer winds are the most constant and predictable. The winds outside the Golden Gate are normally from Northwest to North and are generated by the strong Pacific High Pressure System. This condition lasts through October until the system weakens and the winter cycle starts again. Winds inside the Bay are local depending on the land contours acting on the onshore flow. One of the few occurrences that will alter this pattern is when a high pressure system settles over Washington and Oregon. When this happens a Northeast flow develops, bringing warm dry air and clearing away the summer fog.

Small craft advisory conditions (20 to 25 knots) occur nearly every day in summer through the central and northern San Francisco Bay and eastward through the Carquinez Strait. Wind speeds sometimes locally reach 30 knots in these areas. Gales are rare in summer, but can occur during an unusually intense onshore push.

During the summer months, seas in the coastal waters are mostly generated from local winds and therefore have a short period and tend to be choppy. Large, long-period swells from the open ocean contribute much less to the overall wave height than during the late fall to early spring time frame.

### **Safety Considerations in Severe Weather: Large Vessels, Tugs with Tows 1600 Gross Tons or Greater, and All Tugs with Tows in Petroleum Service**

Extreme wind conditions occasionally require the San Francisco Bar to be closed to vessel traffic. The following practices apply to large vessels of 1600 gross tons or more, to tows with tugs of 1600 gross tons or more, and to tugs in petroleum service. They are meant to serve as guidelines, and are not meant to relieve the mariner of his or her responsibility to follow applicable rules and regulations addressing prudent seamanship.

**Factors to consider when closing the Bar or limiting transits in the Bay.** A number of factors must be considered when limiting transits in the Bay or closing the Bar due to severe weather, including sea state, tidal influences, visibility, traffic density, and wind advisories issued by NOAA. The size, class and condition of the vessels being addressed must also be considered. The HSC recommends a tiered approach, applying greater caution as conditions worsen.

#### ***Sustained winds exceeding 25 knots in the Bay***

- Vessels should closely evaluate whether it is safe to transit in the Bay. Size, class and sail area of the vessel, tidal influences, visibility, and traffic density should all be considered.
- VTS San Francisco will establish regular communications with bridge watches of VTS users in Bay Area anchorages, and more closely monitor swing circles to ensure vessels are not drifting.

#### ***Sustained winds exceeding 40 knots in the Bay***

- Transits to and from berths are not recommended.

#### ***Sustained winds exceeding 40 knots and/or seas exceed 12 ft. at the Sea Buoy***

- Bar traffic restrictions and closure should be considered. Size and class of the vessel, draft, swell period, tidal influences, visibility, and traffic density should all be considered. Strong ebb tides should be avoided, and a minimum of 10 feet underkeel clearance is recommended.

#### ***Procedures for Closing the Bar or Restricting Bar Traffic***

- Bar closures are exercised on a situational basis without specifically defined weather or security conditions.

- The most recent San Francisco Bar Pilot over the Bar, inbound or outbound, shall make the recommendation to the dispatcher that the Bar should be considered for closure, or traffic limited to one-way traffic.
- In the event that the station boat is “boarded off,” then the station boat captain will make the recommendation to the dispatcher.
- The dispatcher will then notify the Operations Pilot, who will notify the Port Agent.
- The Operations Pilot or Port Agent will then notify the U.S. Coast Guard VTS and Command Duty Officer at the Sector San Francisco Command Center.
- The Captain of the Port will consult with the Operations Pilot or Port Agent prior to closing the bar under Captain of the Port authority. The Coast Guard will then issue a Marine Safety Broadcast communicating the closure or traffic restriction.
- The procedure for lifting traffic restrictions or re-opening the Bar will be the same as that for restricting traffic or closing the Bar.
- Vessels under Federal Pilotage or Public Vessel may petition the Captain of the Port to transit the San Francisco Bar.

#### **Safety Considerations in Severe Weather: Tugs with Tows Less Than 1600 Gross Tons Not in Petroleum Service**

The winter months from November to February typically bring storm systems to the Bay area that result in high winds and adverse sea conditions. Extreme wind conditions of 50 knots gusting to 75 knots have occurred during the winter, occasionally requiring the San Francisco Bar to be closed to tug and tow traffic.

These best practices are meant to serve as guidelines, and are not meant to relieve the mariner of his or her responsibility to follow applicable rules and regulations addressing prudent seamanship. Furthermore, they are designed to address vessels in the service of routine cargo transport, and are not meant to prohibit tug rescue or salvage operations.

**Factors to consider when closing the Bar or limiting transits in the Bay.** A number of factors must be considered when limiting transits in the Bay or closing the Bar due to severe weather, including sea state, tidal influences, visibility, traffic density, and wind advisories issued by NOAA. The size and condition of the vessels being addressed must also be considered. The Tug Escort Work Group recommends a tiered approach, applying greater caution as conditions worsen.

#### ***Sustained winds exceeding 25 knots in the Bay***

- Tugs with tows should closely evaluate whether it is safe to transit in the Bay. Size and sail area of the vessel, tidal influences, visibility, operator skill and traffic density should all be considered.

- VTS San Francisco will establish regular communications with bridge watches of VTS users in Bay Area anchorages, and more closely monitor swing circles to ensure vessels are not dragging.

***Sustained winds exceeding 40 knots in the Bay***

- Transits to and from berths are not recommended, but may be performed following a careful risk management evaluation by the vessel operator and vessel management.

***Sustained winds exceeding 40 knots and/or seas exceed 12 ft at the Sea Buoy***

- Bar traffic restrictions and closure should be considered for tugs and tows. Size of the vessel, draft, swell period, tidal influences, visibility, and traffic density should all be considered. Strong ebb tides should be avoided, and a minimum of 10 feet underkeel clearance is recommended.

**Fog**

Fog is a common occurrence in the Bay Area, particularly around the Golden Gate. It is most frequent during the summer, occasional during fall and winter, and infrequent during spring. Although daily and seasonal fog cycles are predictable, long-term fluctuations are not. Fog patterns can differ within the Bay region on the same day because of the unique geography of the Bay, which consists of two mountain ranges and the large expanse of bays and a major river system. Depending on the location, an area may experience high, dense or relatively little fog. The following is a brief summary of fog conditions in the Bay.

**Winter.** Winter fogs are usually radiation fog or “tule” fog. With the clear skies and light winds of winter, land temperature drops rapidly at night. In low, damp places such as the Delta and Central Valley (where tule grass and marsh plants grow), an inversion develops over the inland valleys. Widespread radiation fog will then develop if the surface is sufficiently moist (e.g., after soaking rains). Tule fog is notoriously thick and dense.

In the winter months from late November to early March, fog can develop in the Valley overnight. Visibilities often fall to near zero in the Delta, southern Sacramento Valley, and northern San Joaquin Valley, making marine navigation in these areas difficult. Lowest visibilities occur late during the night through mid-morning hours. Visibilities improve by late morning and often the fog layer lifts into a low overcast during the afternoon.



Sometimes, if there is a light offshore flow during a tule fog event, dense fog can drift westward from the Delta through the Carquinez Strait and into San Francisco Bay. Visibilities can drop below 0.5 mile and stay below 0.5 mile for many hours, and in worst cases, several days. In contrast to the summer fog that moves from sea to land at about 14 knots, the winter tule fogs move slowly seaward at about one knot.

**Summer.** Summer fog is dependent on several routine conditions. The Pacific High becomes well established off the coast and maintains a constant Northwest wind. It also drives the cold California Current south and causes an upwelling of cold water along the coast. Air closest to the surface becomes chilled so that the temperature increases with altitude. This process forms an inversion layer at 500-1500 feet, where the air is warmer at this level than the air below it. Moist, warm ocean air moving toward the coast is cooled first by the California Current, then more by cold coastal water. Condensation occurs and fog will form to the height of the inversion layer. This happens often enough to form a semi-permanent fog bank off the Golden Gate during the summer.

Under normal summer conditions a daily cycle is evident. A sheet of fog forms off the Golden Gate headlands during the morning and becomes more extensive as the day passes. As the temperature in the inland valleys rises, a local low pressure creates a steady onshore wind. By late afternoon, the fog begins to move through the Golden Gate at a speed of about 14 knots on the afternoon sea breeze. Once inside the Bay it is carried by local winds. In general, the northern part of the Bay is the last to be enveloped and the first to clear in the morning. There are times when the flow is strong enough to carry the sea fog as far east as Sacramento and Stockton. If this continues for a number of days, cooler ocean air replaces the warm valley air and causes the sea breeze mechanism to break down. Winds then diminish and the Bay Area clears for a few days; the valley then slowly reheats and the cycle begins anew.

### **Safety Considerations in Reduced Visibility**

Navigating the San Francisco Bay Region during periods of reduced visibility requires mariners to exercise additional caution and vigilance. The Bay region is one of the foggiest harbors in the United States. In-Bay distances are long. There is not a single regional climate, but a series of microclimates with variable fog. During summer, 30 to 40 percent of parts of the Bay may experience foggy conditions. In winter, the fog is generally denser tule fog.

Dense fog is defined by the National Weather Service as fog that reduces visibility to one-half mile or less on the San Francisco Bay or to one mile or less over the coastal waters. Spring and summer fog is not usually dense over the bays and into the Delta and Central Valley. However, fog can often be dense over the coastal waters when the marine layer is shallow (typically less than 1000 feet deep). During shallow marine layer

scenarios, the coastal mountains act as a barrier blocking fog and low clouds from moving inland. Even with a shallow marine layer, fog can still advect into the Bay through the Golden Gate. In this situation, dense fog is almost always limited to local sections of the San Francisco Bay, primarily from the Golden Gate to Berkeley.

**General Guidelines for all vessels.** The following guidelines should be used by the mariner when planning, initiating or transiting on the navigable waters of the San Francisco Bay and Delta Region. Nothing in this guidance precludes vessel Masters, Pilots, and operators from taking proactive measures to ensure the safety of their vessel at all times.

Mariners are at all times to comply with the requirement of the International Regulations for Avoiding Collisions at Sea, or COLREGS.

**Critical Maneuvering Areas (CMAs).** Critical Maneuvering Areas (CMA) are locations within the San Francisco Bay and Delta Region where additional standards of care are required due to the restrictive nature of the channel, proximity of hazards, or the prevalence of adverse currents. The dynamic and unpredictable nature of visibility conditions in the San Francisco Bay can introduce uncertainty and additional risk when transiting these areas.

### **Guidelines for Large Vessels, Tugs with Tows 1600 Gross Tons or greater, and All Tugs with Tows in Petroleum Service Navigating in Reduced Visibility**

**Applicability:** These guidelines apply to the following:

- Large Vessels (power driven vessels of 1600 gross tons or more)
  - Tugs with tows of 1600 gross tons or more
  - **All tugs with tows in petroleum service.**
1. Vessel Masters, Pilots and operators should at all times use proactive voyage planning to attempt to avoid CMAs during periods of reduced visibility.
  2. Vessels should not transit within a CMA when visibility is less than 0.5 nautical mile and should comply with the applicable CMA guidelines listed below.
  3. Vessels should expect delays at berth, anchor or sea if visibility in a CMA along their planned voyage is less than 0.5 nautical mile.
  4. Vessels should make visibility reports as part of their underway report to the VTS and at any point in their transit when visibility conditions change substantially and navigation safety allows the report to be made.

5. Vessel masters, pilots or operators should notify VTS upon determination that a scheduled transit will be delayed or cancelled. If underway, they shall make a sailing plan deviation report per VTS regulations. Should a CMA-related delay introduce additional risks threatening the overall safety of the vessel or the port, then vessel Masters, Pilots, and operators are expected to proactively mitigate these risks through appropriate action and associated communication with VTS.
6. All vessels which encounter unexpected visibility of less than 0.5 nautical mile within a CMA are advised to exercise extreme caution during the transit.
7. **Vessels docked:** Vessels at a dock within the Bay should not commence a transit if visibility is less than 0.5 nautical mile at the dock.
8. **Vessels at anchor:** Vessels at anchor within the Bay should remain at anchor when visibility is less than 0.5 nautical mile at anchorage.
9. **Vessels proceeding to dock:** Vessels proceeding to a dock should anchor if visibility at the dock is known to be less than 0.5 nautical mile, unless, under all circumstances, proceeding to the dock is the safest option.

**The following ten locations within the San Francisco Bay and Delta Region are identified by the Harbor Safety Committee as Critical Maneuvering Areas (CMA). The specific guidelines listed below apply to Large Vessels, Tugs with Tows 1600 Gross Tons or greater, and All Tugs with Tows in Petroleum Service operating in each CMA:**

1. **Redwood Creek :**
  - Vessels should not transit through Redwood Creek when visibility is less than 0.5 nautical mile.
2. **San Mateo-Hayward Bridge:**
  - Vessels should not proceed southbound past San Bruno Shoal Channel Light 1 and Lighted Buoy 2 if the visibility is known to be less than 0.5 nautical mile at the San Mateo-Hayward Bridge.
  - Northbound vessels should not transit through the San Mateo – Hayward Bridge if visibility is less than 0.5 nautical mile.
3. **Islais Creek Channel** (inland from Lash Terminal Approach Lighted Buoy 2 and Lash Terminal Lighted Approach Buoy 5):
  - Vessels should not transit Islais Creek Channel when visibility is less than 0.5 nautical mile.
4. **Oakland Harbor Regulated Navigation Area (RNA):**
  - Vessels should not transit within the Oakland Harbor RNA (33CFR165.1181) when visibility is less than 0.5 nautical mile.

5. **The San Francisco Oakland Bay Bridge (West of Treasure Island):**
  - Outbound/northbound vessels should not transit the San-Francisco Oakland Bay Bridge (West of Yerba Buena Island) when visibility is less than 0.5 nautical mile.
  - Vessels transiting the Bay Bridge CMA in any condition of reduced visibility should generally do so via the A-B or D-E span unless vessel traffic, environmental or other safety factors dictate otherwise.
  
6. **Richmond Inner Harbor (inland from Lighted Buoy 2):**
  - Vessels should not transit within Richmond Inner Harbor when visibility is less than 0.5 nautical mile.
  
7. **Richmond-San Rafael Bridge, East Span:**
  - Southbound vessels should not proceed past Point San Pablo if visibility is known to be less than less than 0.5 nautical mile at the East Span of the Richmond-San Rafael Bridge.
  - Northbound vessels should not enter Southampton Shoal Channel if visibility is known to be less than less than 0.5 nautical mile at the East Span of the Richmond-San Rafael Bridge.
  
8. **Union Pacific Bridge (Benicia-Martinez Railroad Draw-Bridge):**
  - Large vessels must comply with the applicable regulations for the Benicia-Martinez Railroad Draw-bridge and RNA (33CFR165.1181e3).
  - Eastbound tugs and tows < 1600GT in petroleum service should not enter the Benicia-Martinez RNA if visibility is less than 0.5 nautical mile. If visibility reduces to less than 0.5 nautical mile at the UP Bridge after entering the RNA, vessels should not transit the bridge.
  - Westbound tugs and tows < 1600 GT in petroleum service should not proceed past Suisun Bay Channel Lighted Buoy 7 if visibility at the UP Bridge is less than 0.5 nautical mile.
  
9. **New York Slough, up-bound:**
  - Vessels should not proceed past the “NY” buoy marking the entrance to New York Slough when visibility is less than 0.5 nautical mile.
  
10. **Rio Vista Lift Bridge:**
  - Vessels should not transit the Rio Vista Lift Bridge when visibility is less than 0.5 nautical mile.

**Guidelines for Tugs with Tows less than 1600 Gross Tons Not in Petroleum Service Navigating in Reduced Visibility.** (For Tugs with Tows < 1600GT *in petroleum service*, reference the Guidelines for Navigating in Reduced Visibility for Large Vessels.)

Vessel Masters, Pilots and operators should at all times use proactive voyage planning to attempt to avoid CMAs during periods of reduced visibility.

1. Vessels should comply with the applicable CMA guidelines listed below.
2. Vessels should expect delays at berth, anchor or sea if visibility in a CMA along their planned voyage is less than 0.25 nautical mile.
3. Vessels should make visibility reports as part of their underway report to the VTS and at any point in their transit when visibility conditions change substantially and navigation safety allows the report to be made.
4. Vessel masters, pilots or operators should notify VTS upon determination that a scheduled transit will be delayed or cancelled. If underway, they shall make a sailing plan deviation report per VTS regulations. Should a CMA-related delay introduce additional risks threatening the overall safety of the vessel or the port, then vessel Masters, Pilots, and operators are expected to proactively mitigate these risks through appropriate action and associated communication with VTS.
5. All vessels which encounter unexpected visibility of less than 0.25 nautical mile within a CMA are advised to exercise extreme caution during the transit.
6. **Vessels docked:** Tugs with Tows < 1600 GT at a dock within the Bay should not commence a transit if visibility is less than 0.25 nautical mile at the dock.
7. **Vessels at Anchor:** Tugs with Tows < 1600 GT at anchor within the Bay should remain at anchor when visibility is less than 0.25 nautical mile at anchorage.
8. **Vessels proceeding to dock:** Tugs with Tows < 1600 GT proceeding to a dock should anchor if visibility at the dock is known to be less than 0.25 nautical mile, unless, under all circumstances, proceeding to the dock is the safest option.

**The following ten locations within the San Francisco Bay and Delta Region are identified by the Harbor Safety Committee as Critical Maneuvering Areas (CMA). The specific guidelines listed below apply to all Tugs with Tows < 1600 GT Not in Petroleum Service operating in each CMA:**

- Redwood Creek:
  - Tugs with Tows < 1600 GT should not transit through Redwood Creek when visibility is less than 0.25 nautical mile.
- San Mateo-Hayward Bridge:
  - Tugs with Tows < 1600 GT should not proceed southbound past San Bruno Shoal Channel Light 1 and Lighted Buoy 2 if the visibility is known to be less than 0.25 nautical mile at the San Mateo-Hayward Bridge.
  - Outbound Tugs with Tows < 1600 GT should not transit through the San Mateo – Hayward Bridge if visibility is less than 0.25 nautical mile.

- Islais Creek Channel (inland from Lash Terminal Approach Lighted Buoy 2 and Lash Terminal Lighted Approach Buoy 5):
  - Tugs with Tows < 1600 GT should not transit Islais Creek Channel when visibility is less than 0.25 nautical mile.
- Oakland Harbor Regulated Navigation Area (RNA):
  - Tugs with Tows < 1600 GT should not transit within the Oakland Harbor RNA (33CFR165.1181) when visibility is less than 0.25 nautical mile.
- The San-Francisco Oakland Bay Bridge (West of Treasure Island):
  - Outbound/northbound Tugs with Tows < 1600 GT should not transit the San-Francisco Oakland Bay Bridge (West of Yerba Buena Island) when visibility is less than 0.25 nautical mile.
  - Tugs with Tows < 1600 GT transiting the Bay Bridge CMA in any condition of reduced visibility should generally do so via the A-B or D-E span unless vessel traffic, environmental or other safety factors dictate otherwise.
- Richmond Inner Harbor (inland from Lighted Buoy 2):
  - Tugs with Tows < 1600 GT should not transit within Richmond Inner Harbor when visibility is less than 0.25 nautical mile.
- Richmond-San Rafael Bridge, East Span:
  - Southbound Tugs with Tows < 1600 GT should not proceed past Point San Pablo if visibility is known to be less than less than 0.25 nautical mile at the East Span of the Richmond-San Rafael Bridge.
  - Northbound Tugs with Tows < 1600 GT should not enter Southampton Shoal Channel if visibility is known to be less than less than 0.25 nautical mile at the East Span of the Richmond-San Rafael Bridge.
- Union Pacific Bridge ((Benicia-Martinez Railroad Draw-Bridge):
  - Tugs with Tows < 1600GT not in petroleum service should not transit the Union Pacific bridge if visibility is less than 0.25 nautical mile.

New York Slough, up-bound:

- Tugs with Tows < 1600 GT should not proceed past the “NY” buoy marking the entrance to New York Slough when visibility is less than 0.25 nautical mile.
- Rio Vista Lift Bridge:
  - Tugs with Tows < 1600 GT should not transit the Rio Vista Lift Bridge when visibility is less than 0.25 nautical mile.

## Currents and Tides

### Currents

The currents at the entrance to San Francisco Bay are variable and can attain considerable velocity. Immediately outside the Golden Gate bar is a slight current to the North and West known as the Coast Eddy Current. The currents that have the greatest effect on navigation in the Bay and out through the Golden Gate are tidal in nature.

**Golden Gate Flood Current.** In the Golden Gate the flood or incoming current sets (direction of flow) straight in with a slight tendency to the northern shores and with heavy turbulence at both Lime Point and Fort Point when the flood is strong. This causes an eddy or circular current between Point Lobos and Fort Point.

**Golden Gate Ebb Current.** The ebb or outgoing current has been known to reach more than 6.5 knots between Lime and Fort Points. It sets from inside the northern part of the Bay toward Fort Point. As with the flood, it causes an eddy between Point Lobos and Fort Point, and a heavy rip and turbulence reach a quarter of a mile south of Point Bonita.

**Golden Gate Current Maximums.** In the Golden Gate the maximum flood current occurs about an hour-and-a-half before high water, with the maximum ebb occurring about an hour-and-a-half before low water. The average maximums are 3 knots for the flood and 3.5 knots for the ebb.

**In-Bay Currents.** Inside the Golden Gate the flood sets to the Northeast and causes swirls and eddies. This is most pronounced between the Golden Gate, Angel Island and Alcatraz Island. The current sets through Raccoon Strait (north of Angel Island), taking the most direct path to the upper Bay and the Delta area. The ebb current inside the Golden Gate is felt on the south shore first. The duration of the ebb is somewhat longer than the flood due to the addition of runoff from the Sacramento and San Joaquin Rivers.

### Tides

Tides in the San Francisco Bay Area are semi-diurnal in that there are usually two cycles of high and low tides daily, but with inequality of the heights of the two. Occasionally the tidal cycle will become diurnal (only one cycle of tide in a day). As a result, depths in the Bay are based on “mean lower low water” (MLLW), or the average height of the lower of the two daily low tides. The mean range of the tide at the Golden Gate is 4.1 feet, with a diurnal range of 5.8 feet. During the periodic maximum tidal variations the range may reach as much as 9 feet and have lowest low waters 2.4 feet below mean lower low water datum.

**Safety Considerations Associated with Current and Tide Conditions.** In late 1991, the National Oceanic and Atmospheric Administration (NOAA) stopped publishing the local tidal current charts due to significant errors in predictions that exceeded NOAA standards. Because safe navigation is highly dependent upon accurate tidal and current information, the Physical Oceanographic Real Time System (PORTS) was installed to give near-real time tide and current data updated every six minutes. PORTS is managed by the Marine Exchange of the San Francisco Bay Region (SFMX) with technical assistance from NOAA/NOS. Consistent funding is still to be identified for long term operation of the system in the Bay.

PORTS continues to be of great benefit to recreational boaters, commercial shippers, vessel masters and pilots in providing accurate knowledge of winds, currents and other environmental parameters used by the San Francisco maritime community.

Data from the sensors is collected and subject to automatic preliminary quality control at the Data Acquisition System (DAS) located at the SFMX. The data is quality-tested in much greater detail on a 24-hour/7-day per week basis under a program called the Continuous Operating Real Time Monitoring System or CORMS. CORMS employs knowledgeable oceanographers at NOAA's National Ocean Service headquarters in Silver Spring, Maryland, who monitor the data quality and sensor performance using data quality control tests and remote sensor and DAS diagnostics.

Access to PORTS information may be obtained by logging onto the SFMX website at [www.sfm.org](http://www.sfm.org) or by contacting the automated voice response number: (866) 727-6787.

### **Marine Weather Services**

The National Weather Service (NWS), a part of the National Oceanic and Atmospheric Administration (NOAA), provides marine weather warnings and forecasts to serve all mariners who use the waters for livelihood or recreation. The warning and forecast program is the core of the NWS's responsibility to mariners. Warnings and forecasts help the mariner plan and make decisions protecting life and property. The NWS also provides information through weather statements and outlooks that supplement basic warnings and forecasts. The following are the basic marine warning products the NWS offers:

**Small Craft Advisory:** Forecast winds of 22 to 33 knots and/or hazardous sea conditions (usually seas greater than 10 feet).

**Gale Warning:** Forecast winds of 34 to 47 knots.

**Storm Warning:** Forecast winds of 48 knots or higher.

**Dense Fog Advisory:** Visibility reduced to one-half mile or less in the Bay. Visibility reduced to one mile or less in the coastal waters.



**Special Marine Warning:** Potentially hazardous over-water events of short duration (two hours or less) such as thunderstorms with strong gusty winds.

Advisories and warnings listed above are headlined in the Coastal Waters Forecast (CWF). In addition to headlining hazardous weather conditions, the CWF includes forecast information on wind speed and direction, waves, swell, and significant weather (including fog, rain or showers, and thunderstorms). Beginning in March 2006, NWS San Francisco Bay Area began issuing a specific forecast for the San Francisco Bar as part of the Coastal Waters Forecast (CWF) product. The bar forecast includes expected sea state conditions for the next two periods (e.g., tonight and tomorrow), times of maximum ebb current through the Golden Gate and across the bar, and expected hazards such as a small craft advisory for hazardous bar conditions and/or breaking waves on the bar. The bar forecast is updated four times a day along with the rest of the CWF.

### **Marine Warning and Forecast Dissemination**

Marine weather observations, forecasts, and warnings are disseminated through a wide variety of methods, including those listed below.

**NOAA Weather Radio (NWR):** The NWR network provides voice broadcasts of coastal marine forecasts on a continuous cycle. Broadcast coverage extends across the bays and typically offshore about 25 nautical miles. When severe weather threatens, an alarm tone is sent to automatically turn on compatible NWR receivers in the transmitter's coverage area. Transmitters that broadcast in the San Francisco Bay Area include:

<b>Frequency</b>	<b>Call Sign</b>	<b>Location</b>
162.400 MHz	KHB-49	San Francisco (Mt. Pise)
162.500	KDX-54	San Francisco North Bay Marine (Big Rock Ridge)
162.550	KEC-49	San Jose/Monterey (Mt. Umunhum)
162.450	WWF-64	San Jose/Monterey Marine (Mt. Umunhum)
162.425	KZZ-75	East Bay/Delta (Mt. Diablo)

## The Internet

- National Weather Service San Francisco Bay Area: [weather.gov/sanfrancisco](http://weather.gov/sanfrancisco)
- NWS San Francisco Bay Area marine forecast web page:  
[www.wrh.noaa.gov/mtr/marine.php](http://www.wrh.noaa.gov/mtr/marine.php)
- Point and Click Marine Forecast: The NWS now offers the opportunity to get a site-specific forecast instead of relying on a zone forecast:  
[www.wrh.noaa.gov/firewx/fwpfm/fwpfm.php?wfo=mtr&interface=marine](http://www.wrh.noaa.gov/firewx/fwpfm/fwpfm.php?wfo=mtr&interface=marine)

By selecting any spot on the interactive map, the web page user will receive a forecast table that will include specific information on winds, waves, swells and other parameters for the next seven days.

- Buoy and Coastal Observation Information: Wind and wave data from offshore buoys, as well as other coastal weather observations, can be found at:  
[www.wrh.noaa.gov/mtr/buoy.php](http://www.wrh.noaa.gov/mtr/buoy.php)

Buoys data can also be obtained over the phone using the National Data Buoy Center's "dial-a-buoy" service: 1-888-701-8992.

Use the buoy number below when prompted to access the latest buoy observations.

<b>Buoy #</b>	<b>Lat/Long</b>	<b>Location</b>
46013	38.2N/123.3W	Bodega Bay
46026	37.8N/122.8W	San Francisco
46012	37.4N/122.9W	Half Moon Bay
46042	36.8N/122.4W	Monterey
46237	37.8N/122.6W	San Francisco Bar

### III. Aids to Navigation

The waters of the San Francisco Bay Area are marked to assist navigation by the U.S. Aids to Navigation System. This system encompasses buoys and beacons conforming to the International Association of Lighthouse Authorities. The U.S. Aids to Navigation System is intended for use with nautical charts. The exact meaning of a particular aid to navigation may not be clear to an individual unless the appropriate nautical chart is consulted. Additional important information supplementing that shown on charts is contained in the *Light List*, *Coast Pilot* and *Sailing Directions*.

Aids to navigation in the Bay region are regularly reviewed. These reviews, known as the Waterway Analysis and Management System Studies (WAMS), are conducted by the U.S. Coast Guard with input from pilots and other waterway users. One of the results of these reviews was the establishment of new precautionary areas in the Central Bay and its approaches. (The prior traffic routing scheme, originally established in 1972, corrected the problems of contrary vessel movements in the Bay at that time.) The revised traffic routing scheme established a deep water traffic lane and a precautionary area between the Main Ship Channel traffic lanes and the Deep Water Traffic Lane (DWTL). It also established the Central Bay traffic lanes and expanded the associated precautionary areas. The northern traffic lanes were redesigned and the separation zones in the channel deleted. The Coast Guard also established Regulated Navigation Areas (RNAs) for San Francisco Bay and the ship channels of Oakland Harbor, Richmond Harbor/Southampton Shoal Channel, North Ship Channel, Pinole Shoal Channel and the channel under the Union Pacific Railroad Bridge in the Carquinez Strait.

Lighted buoys mark many of the major rocks near shipping channels in the Bay. A lighted buoy and a racon (radar beacon) mark Harding Rock, a submerged rock near the DWTL northwest of Alcatraz Island. Arch and Shag Rocks, which are submerged near Harding Rock, are unmarked. The Coast Guard determined that it was not necessary to mark these rocks. However, in September 1996, the Coast Guard established the San Francisco Bay North Channel Lighted Buoy 1 in position 37-49.9N, 122-24.5W to mark the shoal east of Alcatraz Island for deep-draft vessel traffic.

In addition to the hazards posed by rocks both above and below the water, area bridges create an additional challenge when navigating the Bay. There are racons on most bridges in the Bay Region. This is of major importance because racons are invaluable for radar navigation, particularly in fog, which is common to the Bay. Racons appear on radar screens as large coded signals extending in an arc behind the racon position. With racons placed on the center span of bridges, the mariner can determine the center of the bridge span, even in limited visibility. The Harbor Safety Committee continues to emphasize the importance of racons on bridges.

## IV. Anchorages

Due to the extent of the Bay, a number of federally designated anchorages have been established in the San Francisco, San Pablo, and Suisun Bays and the San Joaquin and Sacramento Rivers. The *Coast Pilot* lists the area's anchorages and limitations. See 33 CFR 110.224 for regulations governing anchorages in the San Francisco Bay region. The regulations can be found in the Code of Federal Regulations at <http://www.ecfr.gov>.

Anchorage 9 is the only anchorage designated by the U.S. Coast Guard Captain (COTP) of the Port where lightering of tankers and bunkering of vessels is allowed. Several explosive anchorages also exist, primarily within Anchorages 5 and 9 (see Map below). Explosive Anchorage 14, within Anchorage 9, was realigned in 1997 to provide deeper water in order to allow vessels laden with explosives, and with drafts of 38 feet or greater, to safely anchor. This also minimized potential overcrowding of vessels anchored within the northern portion of Anchorage 9. Notice of activation of an explosive anchorage is made in the Coast Guard Notice to Mariners to advise vessels not to anchor within the area while vessels are laden with explosives within the Anchorage.

The Vessel Traffic Service (VTS), working in conjunction with the SF Bar Pilots (SFBP) developed an anchorage berthing scheme in anchorage 9 in South San Francisco Bay. This berthing scheme is intended to provide more efficient and organized use of available anchorage space and leverage AIS technology to manage the anchoring of vessels.

The scheme creates twenty-four anchor berths laid out in three north-south columns and eight east-west rows. At the center of each berth is a .1 nautical mile (NM) (200 yards) "drop bucket" inside which vessels are to drop anchor. The layout provides for .6 NM (1200 yards) of north-south separation and .45 NM (900 yards) of east-west separation between vessels, allowing more than sufficient room for vessels to swing with the current without colliding. The western-most column lays .25 NM from the western anchorage boundary and the northern-most row lays .35 NM from the northern anchorage boundary, also allowing vessels to swing with the current while remaining inside the anchorage.

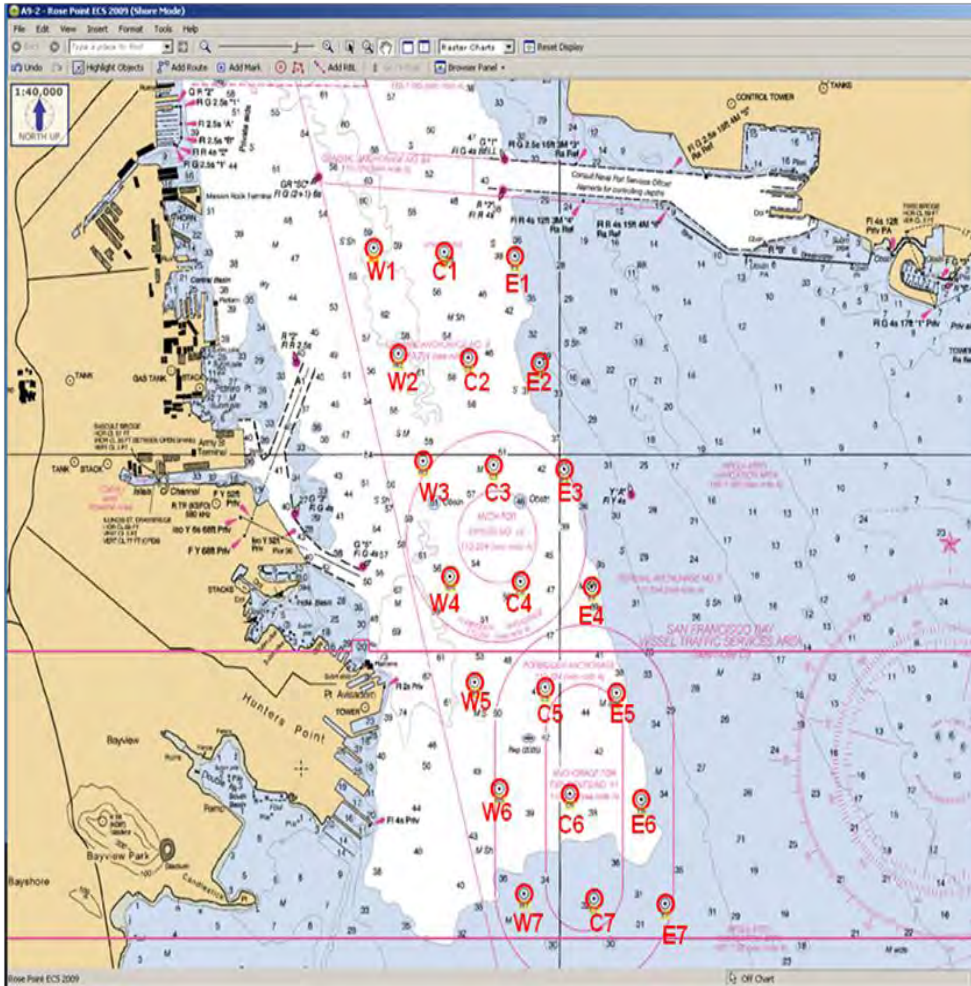

Following successful implementation of the Anchorage 9 scheme, VTS adopted similar schemes for Anchorage 7 west of Treasure Island, and Anchorages 8 and 8A, west of the island of Alameda.

Anchorage 7 can accommodate two vessels requiring temporary anchorage while waiting to proceed to pier facilities or other anchorage grounds. Vessels may not remain for more than 12 hours without COTP authorization, and must be prepared to move within one hour of notification by the COTP. No dangerous cargo or combustible liquids may be loaded unless authorized by the COTP.

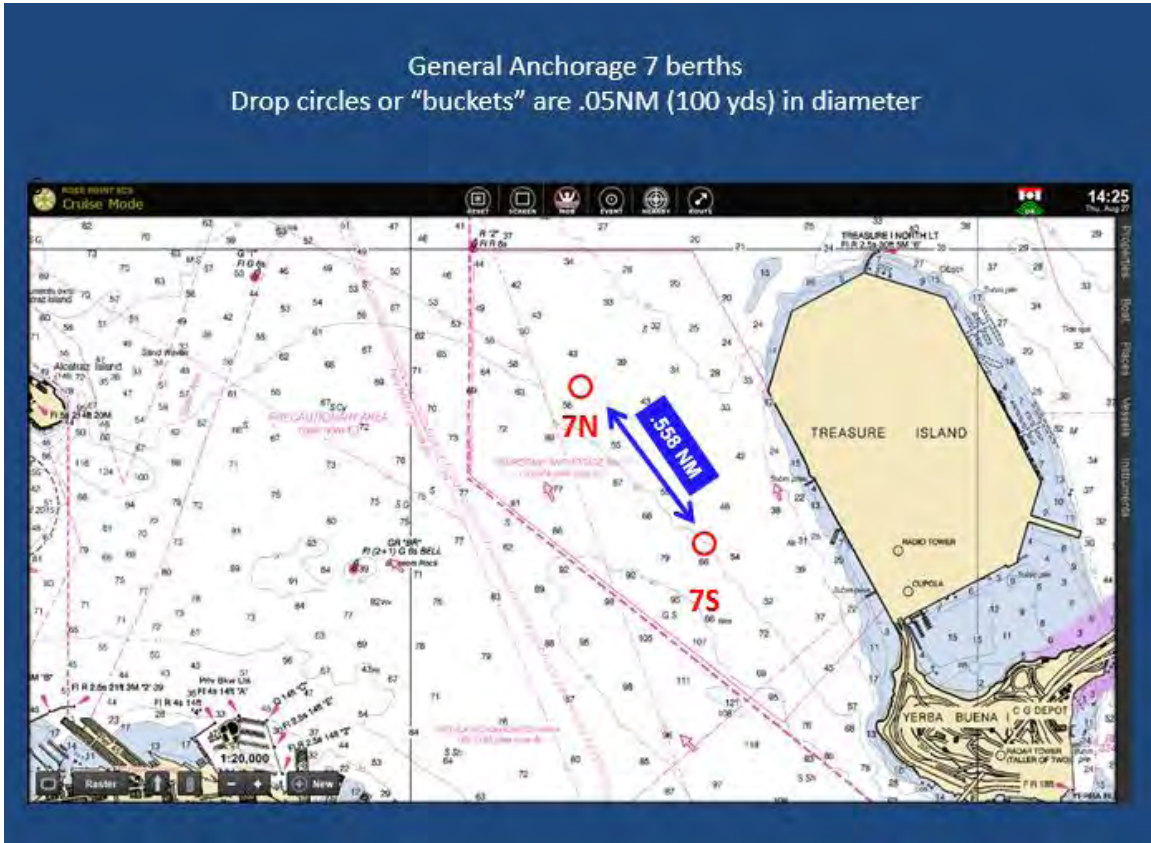



Anchorage 8 accommodates up to five vessels, though two smaller drop buckets with 0.2nm swing circles (8E1 and 8E2) are intended for smaller, lighter draft vessels such as ATBs, Tug/Tow and USCG Cutters.

Anchorage 8A can accommodate a single vessel and is activated by VTS when additional space is needed.

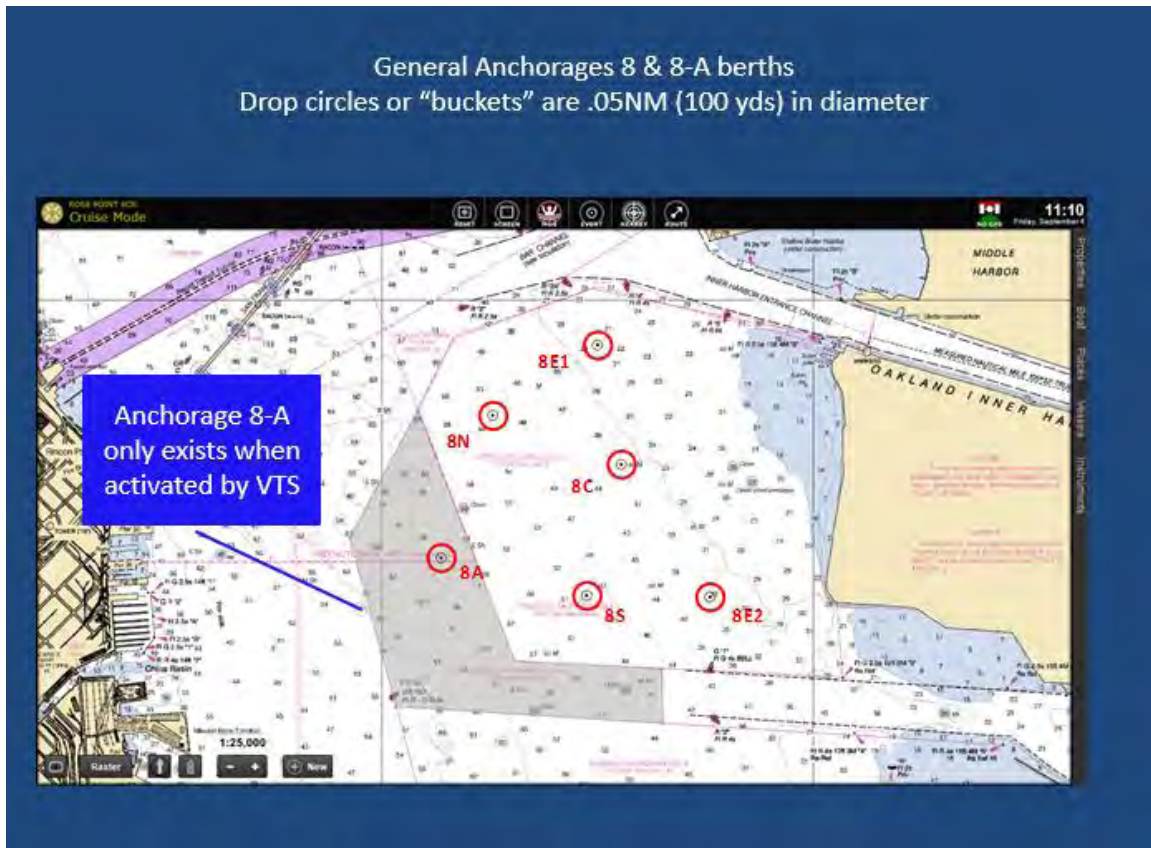

See Appendix A, Anchorages 7-9 Berthing Protocols, for coordinates.

## V. Surveys, Charts and Dredging

The rivers and streams that empty into San Francisco Bay carry large quantities of silt into the harbors and shipping channels of the Bay. Therefore, channel depths must be regularly maintained and shoaling controlled in order to accommodate deep-draft vessels. Beginning in 1868, Congress passed the River and Harbor Act and the federal government began dredging a channel to create a main ship channel in the approaches to San Francisco Bay. Maintenance dredging accounts for approximately 5,000,000 cubic yards of sediments dredged from the San Francisco Bay, Sacramento and San Joaquin ship channels annually.

Actual channel depths may vary from project depths and must be checked with the most recent hydrographic surveys. Presently the project depth of the Main Ship Channel from the Pacific Ocean into the Bay is 55 feet deep and 2,000 feet wide. However, continual sedimentation flowing out of the river systems into the ocean reduces the Main Ship Channel from its authorized depths. According to the U.S. Army Corps of Engineers (USACE), there are no current plans to change the entrance channel's authorized width or depth. The depth of the main channel limits the draft of vessels able to enter the Bay.

During the past century, the federal government deepened a number of shipping channels, removed several shoals and reduced rocks near Alcatraz Island. There are a number of federally dredged channels in the Bay, some of which are narrow. For example, Pinole Shoal is 600 feet wide and the Stockton Main Ship Channel is 200 feet wide. Bay Area ports and channels are maintained to various authorized project depths. (Consult the latest *Coast Pilot 7* or NOAA charts.)

Deep-draft vessels in the Bay are often constrained to navigate only within the main shipping channels. Groundings have been reported in many areas of the region, in part due to the narrow width of many of the channels. Groundings can result in damage to vessels and property, with the potential for serious environmental consequences. A ship aground in a channel can block the transit of other vessels or create new shoaling, and may cause serious delays to Bay commerce. Maneuvering deep-draft ships in narrow channels with minimal underkeel clearance poses high navigational risks, given the complexities of tides, currents and weather conditions in the Bay.



## Surveys

Surveys provide information on actual channel depths, reducing the risk of vessel groundings. The frequent shoaling and silting in the channels of San Francisco Bay and its tributaries require channel surveys to be conducted on a routine basis. Emergency surveys should be conducted when there is evidence that shoaling has occurred. Due to seasonal shoaling, some areas are surveyed on a more frequent basis. Even charts based on modern surveys may not show all seabed obstructions or shallow areas due to localized shoaling.

The variable hydrodynamics of the Bay estuary are due to a number of factors such as drought and flood cycles, dredging projects and in-bay dredge disposal that may affect navigation channels. Strong seismic events may alter the bottom topography of the Bay due to liquefaction and lateral spread. Recent observations have indicated that manmade channels may be influencing tidal currents to a greater degree than anticipated, affecting sediment accretion.

Accumulation of disposed dredged material at the disposal site near Alcatraz Island resulted in the need for a new approach to dredged material management, leading to adoption of the Long Term Management Strategy (LTMS) for the placement of dredged material in the San Francisco Bay region by the state and federal agencies that regulate dredging and disposal. The LTMS provides the basis for uniform federal and state dredged material disposal policies and regulations, with a focus on minimizing in-bay disposal of dredged material.

## Charts

NOAA's Office of Coast Survey (OCS) designed a chart maintenance plan to provide support for the nation's largest commercial ports and trade routes. Selection of these ports and routes is based upon the tonnage and value of goods moving through them.

**Raster Chart Products:** NOAA has been active in developing electronic chart products. NOAA's entire suite of 1,000 nautical charts is available in several formats for free download from the OCS website (<http://www.nauticalcharts.noaa.gov/mcd/NOAAChartViewer.html>).

**Print-on-Demand Charts (POD):** Print-on-Demand (POD) hard copy paper charts are available for purchase from over a dozen certified vendors. An up to date list of NOAA certified POD product distributors is available on the Coast Survey website at: [http://www.nauticalcharts.noaa.gov/staff/print\\_agents](http://www.nauticalcharts.noaa.gov/staff/print_agents).

San Francisco Bay NOAA Nautical Charts			
	Chart Number	Chart Scale	Chart Title
1	18640	1:207,840	San Francisco to Point Arena
2	18645	1:100,000	Gulf of the Farallones
3	18649	1:40,000	Entrance to San Francisco Bay
4	18650	1:20,000	S.F. Bay: Candlestick Pt. to Angel Island
5	18651	1:40,000	S.F. Bay: Southern Part
6	18652	1:80,000	Small Craft Chart: S.F. Bay to Antioch
7	18653	1:20,000	S.F. Bay: Angel Island to Pt. San Pedro
8	18654	1:40,000	San Pablo Bay
9	18655	1:10,000	Mare Island Strait
10	18656	1:40,000	Suisun Bay
11	18657	1:10,000	Carquinez Strait
12	18658	1:10,000	Suisun Bay: Roe Island and Vicinity
13	18659	1:10,000	Suisun Bay: Mallard Island to Antioch
14	18660	1:40,000	San Joaquin River, Antioch to Medford I
15	18661	1:40,000	Sacramento and San Joaquin Rivers
16	18662	1:40,000	Sacramento River
17	18663	1:20,000	Stockton Deep Water Channel
18	18664	1:20,000	Sacramento to Colusa
19	18680	1:210,668	Point Sur to San Francisco

**Vector-Based Charts:** NOAA Continues to roll out vector-based Electronic Navigation Charts (ENC) suitable for Electronic Chart Display and Information System (ECDIS) platforms. The vector charts include “active” information on navigationally significant features such as aids to navigation, bridges, anchorages, obstructions, wrecks, rocks, cables, traffic separation schemes, pipelines, platforms, cautionary and dredged areas. The ENCs for the SF Bay region are compiled and available online at <http://www.charts.noaa.gov/InteractiveCatalog/nrnc.shtml>.

**Hydrographic Surveys:** USACE maintained channels are periodically surveyed by USACE. NOAA periodically surveys other areas of the Bay and its approaches. Specific hydrographic survey requests or concerns can be communicated to the Coast Survey California Navigation Manager. Contact information can be found online at <http://www.nauticalcharts.noaa.gov/nsd/reps.htm>.

### **Navigational Issues Associated with Channel Design and Dredging**

Harding, Shag, and Arch rocks are large submerged rocks located approximately one to one-and-a-quarter nautical miles northwest of Alcatraz Island. The tops of the rocks are 35, 34, and 32 feet respectively below the surface of the water at MLLW. The submerged rocks are within the westbound traffic lane that passes north of Alcatraz Island and is designated for large vessels over 1,600 tons drawing 28 feet or less outbound to sea. Most inbound vessels sail south of Alcatraz Island; however, ships with a draft of more than 45 feet sail north of Alcatraz in the deep water traffic lane in order to maintain safe depths in the deeper waters within this area. Blossom Rock is 39 feet below the surface of the water at MLLW and is located approximately one nautical mile to the southeast of Alcatraz Island, posing a potential hazard to navigation for deep-draft vessels transiting Central San Francisco Bay. Harding, Arch, Shag and Blossom Rocks were lowered many decades ago for the shipping lanes, but today's large tankers and container ships have deeper drafts and now must avoid the submerged rocks.

## VI. Contingency Routing

Dredging and construction may impact the routing of vessels in the Bay. Dredging of the shipping lanes is essential for safe navigation to the ports and marine terminals because so much of the Bay is shallow and subject to sedimentation. Therefore, maintenance dredging occurs on an ongoing basis. In addition, major projects to deepen various ports have taken place to accommodate the modern deep-draft vessels.

The six major bridges that span San Francisco Bay shipping lanes require regular maintenance of bridge fender systems. In addition, there are projects to strengthen the supports of several bridges for the purpose of seismic safety. Maintenance and construction work on the bridges often impacts navigation lanes.

During the many stages of a dredging or construction project that might impact the navigation of vessels, the project proponent and managers consult with pilots, vessel operators, the U.S. Coast Guard, affected port authorities and appropriate agencies. This ensures that consideration is given to the safety of navigation and any restrictions that may impact the movement of vessels.

The USCG Vessel Traffic Service (VTS SF or VTS) has authority under the Ports and Waterways Safety Act to direct vessel movement in case of emergency to ensure the safety and security of the Port. The Captain of the Port has authority to create Safety Zones and to regulate vessel traffic in the event of an oil spill, disaster or emergency.

**San Francisco Vessel Mutual Assistance Plan (SF-VMAP).** SF V-MAP is composed of member vessels, the Coast Guard, and passenger vessel operators who came together to develop an emergency response plan that would ensure a sufficient level of safety exists on small passenger vessels and enhance local capabilities to manage a catastrophic, waterborne Search and Rescue incident.

**Contingency Routing.** Cooperation and consultation between pilots, the USCG, port authorities and appropriate agencies and contractors should continue from the project planning stage through the construction stage of projects that may impact safe navigation in the Bay. The planning stage should include an evaluation of various alternatives to ensure harbor safety. To reduce the risk of accidents occurring during harbor construction, dredging and waterway modification projects, the long-standing permitting procedures of the U.S. Coast Guard, the San Francisco Bay Conservation and Development Commission, the U.S. Army Corps of Engineers, the U.S. Environmental Protection Agency and the San Francisco Bay Regional Water Quality Control Board should be specifically referenced as mandates.

Contractors are responsible for informing the USCG in advance of their planned and actual construction so that the USCG may advise and establish Safety Zones and/or provide cautionary notices and/or rerouting orders to mariners. A Safety Zone is a directive concerning a water area, a shoreline area or a combination thereof to limit access to authorized vessels. The Captain of the Port is authorized to establish temporary Safety Zones. Planning for alternate contingency routing during a construction project is not the responsibility of the Harbor Safety Committee.

Project planning and construction are underway for seismic retrofitting of various major bridges in San Francisco Bay. These seismic retrofit activities will affect mariners on a daily basis for several years. The Coast Guard, with input from the Harbor Safety Committee, has worked with Caltrans, bridge owners and contractors to develop guidelines for construction activity on the bridges. Sector San Francisco, VTS and S.F. Bar Pilots will continue to review the plans for mooring construction equipment at bridge sites to ensure a safe path for navigation. Bridge owners are responsible for ensuring that reliable communications exist between the bridge, the VTS and transiting vessels so they can pass information about the location of construction equipment or other factors affecting navigation.

The Eleventh Coast Guard District, Bridge Section provides information about bridge activities via telephone, letter, Local Notice to Mariners and Broadcast Notice to Mariners as appropriate. Mariners are reminded that heavy rain and high winter flows may result in reduced vertical and horizontal navigational clearances under bridges. Flotsam and drift may accumulate at bridge piers and abutments. Mariners should approach all bridges with caution and due consideration to existing navigational conditions. Notification of bridge-related discrepancies should be provided to the VTS via marine radio or telephone to ensure appropriate Notices to Mariners are issued.

Construction, retrofit and maintenance activities at bridges involve the use of scaffolds, temporary trestles, and marine construction equipment. (See Appendix L, Vehicular Bridge Inventory.) General information about construction activities is provided in the weekly Local Notice to Mariners. Immediate information is provided by Broadcast Notice to Mariners and VTS advisories. Some projects have special considerations such as minimum wake or scaffolding that reduces vertical clearance. The Local Notice to Mariners and VTS provide contact information to the various work sites, allowing mariners access to timely information. Commercial vessels may be asked to provide their "air draft" and their vertical clearance requirement directly to the bridges or to VTS to assist the bridges in anticipating the need for moving scaffolding. Mariners are advised to transit the work site with minimum wake to ensure safe working conditions at the bridge.

The cooperation of the maritime community during essential bridge work is appreciated.

## VII. Vessel Speed and Traffic Patterns

### Ship Traffic

A variety of commercial, military and public vessels enter, exit and transit the Bay. Many vessels such as ferries and tugs remain entirely within the Bay. Container ships, oil tankers and bulk carriers account for the greatest percentage of ship arrivals; however, a broad range of cargo transits the region every year. Other categories of ships include vehicle carriers, break bulk, chemical tankers and passenger ships. Occasionally, surface combatants, submarines and naval auxiliaries such as oil tankers and supply ships transit the Bay. Public vessels often encountered on the Bay include those of the U.S. Coast Guard, the Army Corps of Engineers, NOAA, and the Military Sealift Command.

In order to safely transit the shipping channels to marine oil terminals in the North Bay and Carquinez Strait, some large oil tankers lighter oil to barges or to smaller ships. Lightering is the process of transferring oil from a larger ship tanker into smaller vessels to reduce the draft of the larger tanker. The large tanker can then proceed to a marine terminal and continue discharging the balance of its cargo. Lightering operations in the Bay take place in Anchorage 9 just south of the Oakland-Bay Bridge. The California State Lands Commission provides annual reports of the amount of oil shipped through the region (see Appendices).

### Speed of Vessels

In the Central Bay, where vessel traffic is heaviest, vessels must navigate around Alcatraz Island and transit under the Bay Bridge to the Port of Oakland.

Federal regulation 33 CFR Parts 162 and 165 became effective May 3, 1995 (see Captain of the Port Advisory #05-095 below). These regulations state in part that the maximum speed for all power driven vessels of 1,600 or more gross tons **shall not exceed 15 knots** through the water from the COLREGS Demarcation Line to the southern tip of Bay Farm Island, Alameda and the Union Pacific Railroad Bridge in Benicia. The regulations can be found on the web in the Code of Federal Regulations at <http://www.ecfr.gov>. This standard also applies to a tug with a tow of 1,600 or more gross tons. Power driven vessels of 1,600 or more gross tons shall in any case have their engines ready for immediate maneuver and shall not operate in control modes or with fuels that prevent an immediate response to any engine order ahead or astern or preclude stopping their engines for an extended period of time.

Following the November 7, 2007 allision of the *Cosco Busan* container vessel with the San Francisco-Oakland Bay Bridge, the Navigation Work Group analyzed the facts of the incident to determine if amendments were needed to speed limitations in the Bay to improve navigation safety. After consideration, the Work Group found, and the HSC agreed, that existing speed limitations in San Francisco Bay are adequate.

**COTP Advisory #05-095 (4 May 1995): ENFORCEMENT OF NAVIGATION RULES IN SAN FRANCISCO BAY**

This advisory provides a listing of the major deep-draft channels in San Francisco Bay and adjacent waters which the Captain of the Port considers to be "narrow channels or fairways" within the meaning of the International and Inland Rules of the Road.

Rule 9, in both the International and Inland Rules of the Road, establish requirements for vessels navigating in the vicinity of narrow channels or fairways. Vessels and powerboats less than 20 meters (approximately 65 feet), all sailboats and vessels engaged in fishing shall not impede the passage of a vessel that can safely navigate only within a narrow channel or fairway. Additionally, a vessel shall not cross a narrow channel or fairway if such crossing impedes the passage of a vessel that can safely navigate only within that channel or fairway. The term "shall not impede" means a small craft must keep well clear and not hinder or interfere with the transit of larger vessels. Small craft and fishing vessels shall not anchor or fish in narrow channels if large vessels or barges being towed are transiting.

Coast Guard enforcement efforts, combined with a public education and information program, are further intended to draw public attention to the serious hazards created when smaller vessels impede large vessels. This effort should result in an improved level of navigational safety and reduce the risk of collisions, groundings and their potential consequences.

The Captain of the Port considers the following areas to be "narrow channels or fairways" for the purpose of enforcing the International and Inland Rules of the Road. This list is not all-inclusive, but identifies areas where deep-draft commercial and public vessels routinely operate. Included in this list and marked by an asterisk (\*) are the Regulated Navigation Areas (RNAs) in San Francisco Bay, which were designated in 33 CFR 162 and 165 (May 1995). The regulations can be found in the Code of Federal Regulations at <http://www.ecfr.gov>.

- a. All traffic lanes and precautionary areas in the San Francisco Bay eastward of the San Francisco Approach Lighted Horn Buoy SF (LLNR 360) to the San Francisco -Oakland Bay Bridge and the Richmond -San Rafael Bridge to include:

- \*1. Golden Gate Traffic Lanes which include the Westbound and Eastbound Lanes west of the Golden Gate Precautionary Area.
- \*2. Golden Gate Precautionary Area.
- \*3. Central Bay Traffic Lanes, which include the Deep Water Traffic Lane, The Eastbound Lane (south of Alcatraz Island), and the Westbound Lane (south of Harding Rock).
- \*4. Central Bay Precautionary Area.
- \*5. North Ship Channel between North Channel Lighted Buoy "A" and the Richmond -San Rafael Bridge.
- \*6. Southampton Shoal Channel including the Richmond Long Wharf maneuvering area.
- \*7. Richmond Harbor Entrance Channel and the Point Potrero Reach ending at Point Potrero Turn and including the Turn Basin at Point Richmond.
- 8. Point Potrero Turn.
- 9. Richmond Harbor Channel in its entirety.
- 10. Santa Fe Channel in its entirety.
- \*b. Oakland Harbor Bar Channel including the Outer Harbor Entrance Channel and the Inner Harbor Entrance Channel.
- c. Oakland Outer Harbor.
- d. Oakland Inner Harbor from Inner Harbor Channel Light "5" (LLNR 4670) to, and including, the Brooklyn Basin South Channel.
- e. Alameda Naval Air Station Channel in its entirety.
- f. South San Francisco Bay Channels between the central Bay Precautionary Area and Redwood Creek Entrance Light "2" (LLNR 5180).
- g. Redwood Creek between Redwood Creek Entrance Light "2" (LLNR 5180) and Redwood Creek Day-beacon "21" (LLNR 5265).
- \*h. San Pablo Straight Channel from the Richmond-San Rafael Bridge to San Pablo Bay Channel Light "7" (LLNR 5900).
- \*i. Pinole Shoal Channel in San Pablo Bay between San Pablo Bay Channel Light "7" (LLNR 5900) and San Pablo Bay Channel Light "14" (LLNR 5935).
- j. Carquinez Strait between San Pablo Bay Channel Light "14" (LLNR 5935) and the Benicia-Martinez Highway Bridge.
- k. Mare Island Strait between Mare Island Strait Light "2" (LLNR 6095) and Mare Island Causeway Bridge.
- l. Suisun Bay Channels between the Benicia-Martinez Highway Bridge and Suisun Bay Light "34" (LLNR 6655).



- m. New York Slough between Suisun Bay Light "30" (LLNR 6585) and San Joaquin River Light "2" (LLNR 6670).
- n. Sacramento River Deep Water Ship Channel from Suisun Bay Light "34" (LLNR 6655) to the Port of Sacramento.
- o. San Joaquin River from San Joaquin River Light "2" (LLNR 6670) to the Port of Stockton.

Rules of the Road Enforcement: Timely reporting and enforcement of Rules of the Road infractions promotes safer navigation. Vessel masters, pilots, and operators are encouraged to report incidents, which merit investigation. Reports will be fully investigated and may result in license suspension or revocation proceedings or the assessment of civil penalties.

## VIII. Accidents And Near-Accidents

**Accidents.** The Coast Guard compiles reports of marine accidents or reportable casualties of commercial, military and recreational vessels. A “reportable casualty” is defined in Title 46, Code of Federal Regulations, Part 4 (46 CFR 4.05-1). The regulations can be found on the web in the Code of Federal Regulations at <http://www.ecfr.gov/>.

**Reporting Requirements.** The regulations can be found on the web in the Code of Federal Regulations at <http://www.ecfr.gov/>.

### **Analysis and Actions Taken to Alleviate Accidents.**

Major bridges span shipping channels, connecting various populated areas of the Bay. The bridges are important traffic connectors under which large vessels must carefully navigate between spans. Vessels have struck all Bay bridges during the past 25 years, resulting in damage to the vessels and/or the bridges. Radar beacons (racons) have been added to most of the region’s bridges to enhance the vessel operator’s ability to safely navigate between bridge spans in all types of weather.

In 1992, the Harbor Safety Committee recommended that the Coast Guard and VTS devise a more consistent system of reporting accidents and near-accidents, standardized with other areas, and to analyze the statistics on an annual basis with recommendations for improvements. This recommendation has been essentially accomplished in San Francisco Bay.

As part of this effort, the Harbor Safety Committee worked for adoption of a statewide definition of “near-miss.” The following definition was adopted by the five California Harbor Safety Committees:

A reportable “Near-Miss Situation” is an incident in which a pilot, master, or other person in charge of navigating a vessel, successfully takes action of a non-routine nature to avoid: a collision with another vessel, structure or aid to navigation; the grounding of a vessel; or damage to the environment.

The HSC also participated in establishing a system for voluntary reports of near-miss situations for the Coast Guard in order to prevent vessel accidents. A voluntary reporting form was adopted and included in the Vessel Traffic Service, San Francisco, June 1995 User's Manual. In addition, the Captain of the Port included the report form in the Marine Safety Office newsletter, and the San Francisco Bar Pilots Association made the report form available to its members. However, due to the Freedom of Information Act, the Coast Guard determined that anonymity could not be provided to persons making reports.

The USCG considered a program to address near-misses (or non-reportable near casualties); however, the program was put on hold in November 2002 due to a lack of funding.

## IX. Communication

### Radio Communications

Ship-to-ship and ship-to-shore communication for the maritime community in the San Francisco Bay Area is almost exclusively on marine VHF (very high frequency) radio. The level of usage varies with periods of saturation depending on the time of day and level of vessel traffic. Additional communication modes include telex, fax, internet, cell phones and AIS (Automatic Identification System) messaging.

VHF radio is expected to continue as the primary method for ship-to-ship and ship-to-shore radio communications. Cell phones help to amplify or clarify information that would not normally be passed, or would be limited, over VHF radio. Nonetheless, cell phones are not a substitute for VHF radio as the primary means of communication with and between vessel traffic in the Bay Area.

AIS helps mariners to more quickly identify other vessels thereby reducing the duration and number of radio transmissions.

Please see Chapter XXI for brochures that address radio communication and safe vessel operations available from the San Francisco Marine Exchange.

### Current Usage

CHANNEL	USE
SAN FRANCISCO BAY COMMON FREQUENCY USAGE	
06	Intership safety. Also often used for non-distress traffic between USCG and other vessels.
10	San Francisco Bar Pilots Pilot Boats Agents San Francisco Marine Exchange Chevron Richmond Long Wharf
12	Vessel Traffic Service San Francisco offshore traffic. Used between outer limit of Offshore Precautionary Area and VTS outer limit (38 nautical mile radius from Mt. Tamalpais).
13	Bridge to bridge navigation
14	Vessel Traffic Service San Francisco in-shore traffic. Use from outer limit of Offshore Precautionary Area, throughout San Francisco Bay, up to Stockton and Sacramento.
16	Hailing/distress/safety.
21A	U.S. Coast Guard reserved working frequency between USCG units only.
22	Notice to Mariners

CHANNEL	USE
	U.S. Coast Guard and public working channel
23A	USCG reserved working frequency for communications between USCG units and other vessels.
7A, 11, 77 18A, 19A	Common tug working frequencies.
79A, 80A, 88A	Commonly used by fishing vessels.
7A, 8, 9, 11, 18A, 19A	Port Operations — Commercial intership and ship to shore working channels. Commercial vessel business and operational needs.
9, 68, 69, 71, 72, 78A	Port Operations — Non-commercial; supplies repairs, berthing, yacht harbors/marinas.

TUG COMPANY CHANNELS	
9	Westar Marine Services
10	Crowley Marine Services Foss Maritime Company
18A	AMNAV Maritime Services Baydelta Maritime Brusco Tug & Barge Oscar Niemeth Towing SeaRiver Maritime Seaway Towing Company Starlight Marine Services
MARINE OPERATORS	
26, 84, 87	San Francisco
27, 28, 86	Sacramento, Stockton, Delta
VESSEL TRAFFIC SERVICE RADIO COVERAGE	
VTS has complete radio coverage throughout the region on its designated frequencies.	

### Existing Limitations

Due to the many hills in the region that restrict line of sight, VHF Channel 13 has a number of blind spots because of the one-watt transmission limitation on the channel.

### Equipment

1. **San Francisco Vessel Traffic Service (VTS).** VTS communications equipment consists of four remote sites located throughout the region that ensure complete VHF radio coverage of the VTS area.

2. **San Francisco Bar Pilots.** The San Francisco Bar Pilots' headquarters is located at the East end of Pier 9, San Francisco. The antenna for their primary system is located on Mt. Tamalpais.

3. **San Francisco Marine Exchange.** The Marine Exchange is located at 505 Beach Street in San Francisco. The Exchange shares the antenna on Mt. Tamalpais with the Bar Pilots. Their communication equipment includes:

A 50-watt transceiver on Channel 10.

A standard transceiver with a local antenna monitoring Channels 13, 14, & 18A.

### **Marine Exchange Communication System**

The San Francisco Marine Exchange, a non-profit agency that serves as the Clearing House for tug escorting of regulated tankers and barges, has backup battery systems and generating capacity for its computer, phone, and radio systems.

## X. Bridges

The San Francisco Bay Area is crossed by a number of bridges that carry automotive and rail traffic. Most shipping traffic transits through moveable or fixed bridges with adequate vertical clearance for normal passage.

### Geographic Boundaries

The boundaries of the area in this chapter are set in the West by the COLREGS Demarcation Line (Between Pt. Bonita and Mile Rocks), and in the East to include the Rio Vista Highway Bridge in the Sacramento River and the Antioch Highway Bridge in the San Joaquin River.

### Schedule of Bridge Openings

Oceangoing vessels may transit under two vertical lift bridges, the Benicia-Martinez Railroad Drawbridge and the Rio Vista Highway Drawbridge. Both bridges are operated 24 hours a day and open for vessel traffic upon request. Approximately 30 minute notice is beneficial and the bridges may be contacted by VHF or telephone.

For vessels intending to transit through the Benicia-Martinez Railroad Drawbridge, there is a well-established protocol for requesting a lift. Copies of the protocol are available at the VTS website, [www.uscg.mil/D11/vtssf/](http://www.uscg.mil/D11/vtssf/).

BRIDGE	VHF CHANNELS	PHONE NUMBER
Benicia-Martinez RR Bridge	13	(925) 228-5943
Rio Vista	9, 13, 16	(707) 374-2134

### Adequacy of Ship-to-Bridge Communications

Ship to bridge communications takes place via VHF radio on designated channels or as required by drawbridge regulations (Title 33 CFR 117). Communications are considered to be adequate by the local maritime community.

## Physical Characteristics of Bridges

When required by the Eleventh Coast Guard Bridge Office, under the provisions of Title 33 Code of Federal Regulations, Part 118, bridges over navigable waterways in the Eleventh Coast Guard District, are lighted and marked as permitted obstructions on the waterway. Standard markings include a range of two green lights marking the center of the bridge, which in the case of drawbridges, will shift from green to red when the drawspan is in anything but the full open-to-navigation position. Bridge piers in or adjacent to the navigational channel may be lighted at night with fixed red lights to identify them as obstructions. When required, bridges are equipped with sound producing devices that are used during periods of reduced visibility.

The region now has 12 Racons mounted on bridges. A racon is a radar sensor (radar beacon) that sends out a radar emission that shows up as a distinctive mark on a ship's radarscope. The racons were installed because there is a high volume of vessel traffic transiting under bridges and the Bay Area has the highest number of foggy days in the nation when visibility is less than one-half mile.

Racons are located on the following Bay Area bridges:

- Benicia-Martinez (1)
- SF-Oakland Bay Bridge (3)
- Richmond-San Rafael Bridge (2)
- San Mateo-Hayward Bridge (1)
- Antioch Bridge (1)
- Rio Vista Bridge (1)
- Golden Gate Bridge (1)
- I-80 Crocket-Vallejo (2)

**Bridge Clearances** (See Appendices for most recent list of bridge clearances.)

### Benicia-Martinez Railroad Drawbridge

To improve navigational safety for all vessels sailing through the relatively narrow opening of the drawbridge at Benicia, the Coast Guard has completed a number of initiatives:

- Established a Regulated Navigational Area (RNA) at the bridge, which prohibits deep-draft vessel transits when visibility is less than 1000 yards. The Coast Guard revised the RNA to change the name of the bridge to the Benicia-Martinez RR Bridge, added a third visibility checkpoint, and clarified the procedures for downbound vessels that are moored or anchored between the Railroad Drawbridge and New York Point (that intend to transit the RNA once underway).



Installed white lights on the main channel piers to better identify the primary navigation channel. The white pier lights recommended for installation on the main channel piers have provided better visibility in foggy conditions and have been made permanent.

Asked the Union Pacific Railroad (UPRR) to change the working frequency of the bridge radiotelephone to VHF Channel 13, to allow vessels and bridge operators to communicate directly instead of using Vessel Traffic Service Channel 14. This change went into effect in 2001.

Investigated bridge malfunctions and created natural working group to find solutions to process and equipment problems.

Had Caltrans make modifications to the RACON on the adjacent highway bridge, which has improved the signal to downbound vessels.

Most of the recommended bridge improvement items have been completed by UPRR. UPRR has installed a new auxiliary power system including a new generator and transformers, along with a new signal system. New enhancements include replacement of the bridge lift motors, installation of a computerized system to monitor train locations and track conditions and a computer system to track vessels upbound or downbound for the bridge.

To preserve the solutions implemented as a result of the natural working group (2000-2005), concerning the operation of the Benicia-Martinez Railroad Drawbridge, rail and waterway industry representatives and the Coast Guard continue to meet semi-annually to discuss problems with the bridge and to develop solutions. In addition to the elimination of near miss ship events with the bridge, there has been a significant reduction in rush-hour commuter rail and Amtrak traffic delays, due to the coordination by the SF Bar Pilots to make minor adjustments in ship arrival times at the bridge, when possible, to avoid impacting scheduled commuter rail traffic.

## **XI. Small Passenger Vessels – Ferries**

Small passenger vessels (ferries) operate year round on San Francisco Bay, San Pablo Bay and their tributaries, carrying nearly six million passengers on 240 transits per day. In total, passenger vessels made up nearly 60 percent of all transits tracked by the San Francisco USCG Vessel Traffic Service (VTS) in that year. Other ferries carry tourists and dinner cruises year round in the Central Bay.

In 2007, the state legislature established the San Francisco Bay Area Water Emergency Transportation Authority (WETA), as a regional agency with responsibility to develop and operate a comprehensive Bay Area public water transportation system and to coordinate the emergency response of waterborne transit. WETA is charged with coordinating emergency response activities for water transit services in cooperation with MTC and other agencies, consistent with the provisions of July 2009 Emergency Response.

In June 2012, WETA launched its first new ferry route connecting South San Francisco's Oyster Point Marina and Oakland's Jack London Square. WETA carries more than 1.9 million passengers annually on a fleet of 12 high-speed ferry vessels, serving the cities of Alameda, Oakland, San Francisco, South San Francisco and Vallejo.

Because of concerns associated with an increasing number of commuter ferries sharing the Bay with large shipping vessels and recreational boaters, the HSC requested the Ferry Operations Work Group develop an approach and maneuvering scheme in the vicinity of the congested San Francisco Ferry Building, as well as a routing protocol in the Central Bay to decrease the risk of collision for commute ferries. The routing was adopted by the HSC in 2008, and is included at the end of this chapter.

### **Small Passenger Vessel Services**

Small passenger vessels are defined as less than 100 gross tons that are inspected and certified by the U.S. Coast Guard to carry passengers for hire. "T" vessels carry fewer than 149 passengers, "K" vessels carry more than 149 passengers. One "H" vessel (larger than 100 gross tons) is based in San Francisco.

**Note:** This overview is meant to describe larger private and public vessel operators and does not include the sport fishing or smaller vessel operators that meet the definition of small passenger vessel.

**Ferry:** Regularly scheduled, operate year round, and provide point-to-point service.

**Regularly-Scheduled and Excursion:** Seasonal and year round scheduled service, including sightseeing tours, dining, and/or entertainment.

**Geographical Scope.** Ferry routes bring passengers from outlying cities in the region to the city of San Francisco. Excursion routes operate primarily in the central San Francisco Bay. The following are small passenger vessel terminal locations as of June 2012:

- San Francisco Downtown Ferry Terminal
- Fisherman’s Wharf, San Francisco
- San Francisco China Basin Ferry Terminal
- Oyster Point, South San Francisco
- Larkspur Terminal
- Gateway Alameda
- Clay St. Oakland
- Harbor Bay Isle, Alameda
- Vallejo
- Sausalito
- Tiburon

Small passenger vessels also operate on an unscheduled basis out of marinas in Sausalito, Alameda, Oakland and Berkeley.

### **Small Passenger Vessel Safety Program**

**U.S. Coast Guard San Francisco Vessel Mutual Assistance Plan.** The purpose of the San Francisco Vessel Mutual Assistance Plan (SF V-MAP) is to ensure that a sufficient level of safety exists. It is intended to enhance local capabilities to effectively manage a catastrophic, in port Search and Rescue incident. The objectives of the SF V-MAP are to:

1. Create a “sufficient level of safety” as required by 46 CFR 117.207(f).
2. Provide effective and expedient emergency support by member vessels for a marine search and rescue operation on San Francisco Bay involving a large number of victims or potential victims.
3. Ensure lifesaving equipment available on each member vessel is appropriate for the waters of San Francisco Bay.
4. Promote professionalism in emergency preparedness and response.
5. Provide, through mutual assistance, a more effective and timely means to rescue all persons in the water (PIW).

## Best Practices

S.F. Bay Area ferry operators participated in the Harbor Safety Committee Ferry Operations Work Group to develop common best maritime practices for safe passenger vessel operation in the Bay.

**San Francisco Bay Area Ferry Operation in Inclement Weather.** As described in the Harbor Safety Plan, localized microclimates can alter visibility along an entire route or a portion of a route. During summer, channel fog is prevalent in the central San Francisco Bay with outer areas clear. In winter months Tule fog can be widespread, dense in the morning with clearing later in the day.

The Master of a ferry is the person in charge of the vessel, responsible for the safety of the passengers and crew at all times, and has the authority to decide if it is safe to get underway or to proceed.

In reduced **visibility** and **inclement weather conditions**, the following practices are followed:

- A go or no-go decision to get underway is made by the vessel Master or the company Operation Manager, based on conditions along the entire route, using all available information including the experience of the Master and operations manager.
- Look-outs: the vessel Master assigns crewmembers for look-out duty based on the existing or anticipated conditions; the applicable regulations are found in the Navigation Rules and Regulations, Rule 5 Look-out (text attached).
- Safe speed: the vessel is required to proceed at a speed appropriate to the prevailing circumstances and conditions, which include state of visibility and the manageability of the vessel with special reference to stopping distance and turning ability. Other factors include participation in fixed ferry routes, wind advisories issued by NOAA, sea state, traffic density, and applicable Navigation Rules and Regulations (see attached verbiage from Rule 6 Safe Speed).
- Equipment: each ferry is required to have at minimum one radar; commuter ferry vessels generally have two operational radars onboard; the vessel Master is required to have a radar observer license endorsement. Global Positioning Satellite, Automatic Identification System and Electronic Charting navigation systems are also installed and used to assist navigation.

In conditions of **high wind and waves**:

- Go/no-go decision is made by the vessel Master or the company Operation Manager, based on conditions along the entire route, using all available information including the experience of the Master and operations manager. Factors to be considered include size of the vessel, direction of the winds and seas, orientation of departure and arrival piers to prevailing conditions, and limitations of ferries to travel at slower speeds.
- Passenger safety: Captain can maneuver the vessel to minimize wave effects. Crew duties include rough weather announcements and passenger safety management.

**High Speed Ferry Operations (over 30 Knots)**. U.S. Coast Guard Navigation and Vessel Inspection Circulars (NAVIC) 5-01 and 5-01 Change 1 provide specific guidance for high speed passenger vessels and include approved vessel operation manuals, training programs and risk assessment tools (matrix).

- Vessel equipment: operators have exceeded minimum requirements for navigation electronics including dual radar, Global Position Satellite and electronic charting with Automatic Identification System overlay.
- Manning/Training: Vessels traveling at high speed are required to have a minimum of two qualified watch-standers during normal operations. Vessel operators have developed approved training programs for high speed navigation in compliance with NAVIC 5-01 and 5-01 Change 1.

### **Ferry Traffic Routing Protocol**

The Ferry Traffic Routing Protocol consists of planned routes and communications procedures for improving ferry navigation safety. When ferries follow routes, the Closest Point of Approach (CPAs) with other ferries is greatest at points where speeds are typically greatest. The adopted routes cross at predetermined locations at nearly right angles, enabling ferries to predict crossing situations and plan ahead.

Within an approximately one-half nautical mile zone around the San Francisco Ferry Building, the protocol calls for port-to-port meeting and heightened radio communications. For inbound Ferry Building ferries, the protocol requires planning far enough in advance to avoid getting within approximately one-half nautical mile from the Ferry Building if another ferry is still at the inbounder's dock.

This reduces crowding around the Ferry Building. With ferry routes charted on nautical charts, other types of vessels can more easily predict the locations of ferries and steer clear. The Ferry Traffic Routing Protocol supports aggressive use of electronic nautical charts (ENCs) with intergraded Automatic Identification System (AIS). When all ferries consistently update their AIS data and follow routes, the protocol will ultimately lead to reduced VTS-ferry communications.

Ferry routes and the Ferry Building Approach Zone are shown in Appendix A and are incorporated herein.

## **XII. Small Vessels**

### **Background**

Within the Bay, many recreational boats and commercial fishermen transit navigational shipping lanes and some approaches to port and marine terminal facilities. The central part of the Bay, with the heaviest concentration of population in close proximity to the shoreline, has the largest number of small boat marinas along the San Francisco, Alameda, Contra Costa, and Marin County shorelines. Two-thirds of approximately 20,000 Bay Area marina berths are located in the Central Bay. This number does not include facilities on the Sacramento and San Joaquin Rivers.

The last Sunday in April (Opening Day on the Bay), Memorial Day, Labor Day, Independence Day and Fleet Week are times of extreme congestion by small vessels. There are many occasions where six or eight races may be held in the same venue, with vessels starting at five-minute intervals. This may lead to more racing congestion than a single large popular regatta. Race instructions now carry a warning regarding interference with large vessels.

Motorized vessels occupying berths in the Bay area constitute only 15 percent of registered vessels using the Central Bay. Numerous boat ramps and launches encourage use of the Bay by smaller motorized vessels and increasingly popular non-motorized vessels such as canoes, kayaks, windsurfers and paddleboards. While only a percentage of boat owners and renters are on the Bay at any given time, sunny weekends may bring thousands of pleasure boat users on the Bay's waterways.

Coast Guard, commercial ship, tug and ferry operators note that small craft are difficult to spot in periods of limited visibility, and present a poor or non-existent image on radar. Because of the limited navigable channels in the Bay, small craft may constitute a hazard to navigation.

In addition to the Bay's commercial fishing fleet, comprising approximately 1,000 boats, charter boats carrying numerous fishermen also fish the Bay and areas west of the Golden Gate Bridge. However, of this number, about 150 to 200 boats, principally berthed in San Francisco, Sausalito and Oakland, are used full-time for commercial fishing. Many of the licensed commercial fishermen are part-time operators, fishing on weekends and holidays by trailering small boats to launch ramps. In the Bay the only commercial fish caught are herring, anchovies and halibut, with herring the most important in-Bay fishery. During the December to March herring season, additional boats from other areas enter the Bay to lay their nets. The State Department of Fish and Wildlife controls the number of boats fishing in the Bay during the herring season and regulates the manner of fishing.

## Vessel Traffic Incidents

**Sail and motor boats.** Thousands of recreational boats are concentrated near the major inbound and outbound Bay shipping lanes. While many sailboats and motorboats are on the Bay, particularly on weekends, few near-misses or accidents are reported to the Coast Guard or Vessel Traffic Service. A number of reported and unreported near-misses may be prevented by small boats properly yielding the right-of-way to large vessels that cannot change course.

**Kayaks, sail and paddle boards.** A number of near-misses have been reported to the HSC by passenger ferry and cargo vessel operators over the past several years. Tragically, a fatality occurred in 2011 when a paddler was swept out of his kayak and never found when he tried to ride the prop wash of two operating tugs along the San Francisco waterfront. Also reported, a number of board sailors cross in front of tankers and container ships off Crissy Field, which is close to the Golden Gate Bridge. Competitive races are sponsored at this location throughout the year. Paddle boarders and kayakers attempt to traverse the Oakland Estuary turning basin while tugs are moving large container ships in the confined area.

**Fishing boats.** Many commercial and recreational fishermen have worked side by side with inbound and outbound ship traffic plus in-Bay vessel traffic for many years. Once commercial fishing gear is set in an area, it will remain in that location for a period of time. Subject to winds and tides, the gear may move in directions the fisherman may not have intended. Since this may create an obstruction, a warning regarding possible interference with other vessels should be made to VTS.

The following boater education programs are available to the boating public in the nine Bay area counties.

	<b>Subjects</b>
U.S. Power Squadrons <a href="http://www.usps.org">www.usps.org</a>	Boating Safety Rules of the Road, Basic Rescue
U.S. Coast Guard Auxiliary <a href="http://www.cgaux.org">www.cgaux.org</a>	Boating Safety Rules of the Road, Basic Rescue
California Dept. of Boating and Waterways <a href="http://dbw.ca.gov/BoaterInfo/BSClassesAndCourses.aspx">http://dbw.ca.gov/BoaterInfo/BSClassesAndCourses.aspx</a>	Water Safety/Grades K–12, General
National Association of State Boating Law Administrators <a href="http://www.NASBLA.org">www.NASBLA.org</a>	Variety of courses

In addition, the U.S. Coast Guard has a website dedicated to promote boating safety: [www.uscgboating.org](http://www.uscgboating.org).



Mandatory boater education and licensing in California is slated to begin in 2018, affecting only boat operators under 20 years of age.

USCG-mandated Rule 9 applies to all vessels, and is enforced in California by various local agencies such as Sheriff's patrols, as well as USCG. RULE 9 places the obligation on the small [under 20 meters] vessel operator to avoid impeding a large vessel while operating in a deep draft channel or fairway.

Rule 5 states: "Every vessel shall at all times maintain a proper look-out by sight and bearing as well as by all available means appropriate to the prevailing circumstances and conditions so as to make a full appraisal of the situation and of the risk of collision."

### **XIII. Vessel Traffic Service**

The U.S. Coast Guard established the Vessel Traffic Service (VTS SF or VTS) in San Francisco Bay in 1972, following a serious collision between two tank vessels that resulted in great environmental damage to the Bay. The Coast Guard continues to operate the VTS system and monitors nearly 400 vessel movements per day. The region is considered a difficult navigation area because of its high-traffic density, frequent episodes of fog and challenging navigational hazards. In 1996 Congress considered reducing the current level of funding for VTS SF. In response, the Harbor Safety Committee voted to support continued federal funding to maintain VTS SF at its current level in order to ensure navigational safety in the Bay.

The VTS for the San Francisco Bay region has six components: (1) Automatic Identification System (AIS), (2) radar and visual surveillance, (3) VHF communications network, (4) a position reporting system, (5) traffic schemes within the Bay, and (6) a 24-hour center that is staffed with specially trained vessel traffic control specialists.

The geographic area served by VTS SF includes San Francisco Bay, its seaward approaches, and its tributaries as far as Stockton and Sacramento.

#### **VTS Mission**

The primary mission of VTS San Francisco is to coordinate safe, secure and efficient transit of vessels in San Francisco Bay, including its approaches and tributaries, in an effort to prevent accidents or terrorist actions, which could result in loss of life, damage to property or the environment.

VTS implements and enforces the portions of the Ports and Waterways Safety Act that enhance navigation, vessel safety and marine environmental protection and promote safe vessel movement, by reducing the potential for collisions, allisions and groundings, and the loss of lives and property associated with these incidents.

VTS provides the mariner with information related to the safe navigation of a waterway. This information enhances the safe routing of vessels through congested waterways or waterways of a particular hazard. Under certain circumstances, VTS may issue directions to control the movement of vessels in order to minimize the risk of collision between vessels, or damage to property or the environment.

The owner, operator, charterer, master or other person directing the movement of a vessel remains at all times responsible for the manner in which the vessel is operated and maneuvered and is responsible for the safe navigation of the vessel under all circumstances.

## **VTS Authority**

VTS regulatory authority comes from 33 CFR 161 Vessel Traffic Service Regulations. These regulations give VTS the authority to manage, control or direct vessel traffic within the VTS area. VTS may issue measures or directions to enhance navigation and vessel safety and to protect the marine environment, including, but not limited to:

1. Designating temporary reporting points and procedures;
2. Imposing vessel operating requirements; or
3. Establishing vessel traffic routing schemes.

The regulations can be found on the web in the Code of Federal Regulations at [www.ecfr.gov](http://www.ecfr.gov)

During conditions of vessel congestion, restricted visibility, adverse weather, or other hazardous circumstances, VTS may control, supervise, or otherwise manage traffic, by specifying times of entry, movement, or departure to, from, or within a VTS area.

Participation is required for all vessels that fall under the Bridge-to-Bridge Radio Telephone Act. Active participation (through a series of reports) is required for all vessels that fall under the Vessel Movement Reporting System (VMRS), defined as: power-driven vessels 40 meters in length or greater; tugs, 8 meters or greater while towing; and passenger vessels certificated to carry 50 or more passengers for hire.

Through the exchange of vessel transit information, VTS provides vessel operators with up-to-date information, thereby facilitating safe transits for vessels interacting on the waterways.

## **VMRS Reporting Requirements**

### **Sailing Plan Report**

Unless otherwise stated, at least 15 minutes before navigating a VTS area, a vessel must report the:

- (a) Vessel name and type;
- (b) Position;
- (c) Destination and ETA;
- (d) Intended route;
- (e) Time and point of entry; and
- (f) Dangerous cargo on board or in its tow, as defined in 33CFR160.202.

Position Report

A vessel must report its name and position:

- (a) Upon point of entry into a VMRS area;
- (b) At designated reporting points as set forth in subpart C; or
- (c) When directed by the Center.

Note: Vessel position reporting requirements vary depending on a vessel's ability to transmit AIS information to VTS.

Sailing Plan Deviation/Amplification Report

A vessel must report:

- (1) Any significant deviation from its Sailing Plan or from previously reported information; or
- (2) Any intention to deviate from a VTS issued measure or vessel traffic routing system.

Final Report (FR).

A vessel must report its name and position:

- (a) On arrival at its destination; or
- (b) When leaving a VTS area.

**Offshore.** Vessels are required to make radio reports on VHF Channel 12 when entering or exiting the offshore VTS reporting area, which extends approximately 30 miles west from the Golden Gate Bridge. Inbound vessels are required to report 15 minutes prior to crossing the offshore boundary, upon entering the respective Traffic Separation Scheme (TSS), and upon entering the precautionary area. Outbound vessels are required to report once at the San Francisco Sea Buoy, again at the TSS entrance buoy, at the terminus of the TSS and finally at the outer boundary of the VTS area. Radio reports include the name and type of vessel, route, course, speed, position and estimated times of arrival to various geographic locations. The VTS broadcasts a traffic report every 30 minutes: at minute 15 and 45 of each hour.

**Within the Bay.** Vessels report 15 minutes prior to and upon getting underway, docking, mooring, or anchoring or when departing from the VTS area. Position reports are also made when passing under most bridges, when pilots change, when emergencies arise and when deviating from standard procedures. Ferries operating on a scheduled route make one report prior to departure, and do not report again unless they deviate from their schedule or route.

### **Traffic Routing within San Francisco Bay**

On May 3, 1995, the Coast Guard established seven Regulated Navigation Areas (RNAs) to reduce vessel congestion where maneuvering room is limited. These RNAs apply to the waters of the Central Bay, Oakland Harbor, San Pablo Bay, and the Benicia-Martinez Railroad Bridge. There are four VHF radio/communications sites located throughout the Bay which give VTS full radio coverage. VTS operates on channel 14 VHF for inshore traffic and channel 12 for offshore traffic, and monitors channel 13 throughout the VTS area.

### **VTS Training Program Overview**

VTS Operators undergo extensive training. Before these traffic management specialists begin on-the-job training in the Operations Center, they undergo three months of intensive training at the VTS in the classroom and self-study, plus up to three weeks of offsite training. Offsite training typically includes a two week National VTS Certification course and a one-week Nautical Rules Course. All training is tailored to the individual needs of the trainee.

After this initial classroom and self-study period, new Operators/Traffic Management Specialists then undergo three to four months of closely supervised on-the-job training. This training cycle can be shortened if the person has previous VTS experience; however, the average time for a new employee to become qualified in their primary job is six months. New supervisors can take an additional two to three months before qualification.

### **Outreach and Partnership**

The San Francisco Bar Pilots and the U.S. Coast Guard Vessel Traffic Service San Francisco, as well as other members of the maritime community, continue to share professional information in order to foster a team approach to the issue of navigation safety within the San Francisco Bay Area. VTS participates in the following outreach and partnership programs:

**VTS-Pilots Issue Committee (VPIC).** Founded in 1995, the VPIC—comprised of the VTS Director, Operations Center Supervisor, Training Coordinator and members of the San Francisco Bar Pilots—meets as needed to discuss how VTS and the Bar Pilots can better serve each other. Both agencies might bring in scenarios or review recordings, then discuss the interactions from their respective points of view. For example, VTS may explain why a particular deviation request from RNA regulations was not granted. With the VPIC interaction, VTS can explain the response from a VTS perspective, and the pilots can then explain why a requested deviation seemed safer from the pilot’s point of view.

In addition to providing a forum for discussion, VPIC has produced an anchorage berthing protocol, the development of a communication protocol to resolve communication issues around marine construction projects, and the refinement of reporting procedures in order to provide mariners with more accurate reports of ongoing marine construction in the Bay area.

**San Francisco Vessel Mutual Assistance Plan (SF-VMAP).** SF-VMAP is composed of member vessels, the Coast Guard and passenger vessel operators who came together to develop an emergency response plan that would ensure that a sufficient level of safety exists on small passenger vessels and enhance local capabilities to manage a catastrophic, waterborne Search and Rescue incident. VTS was active in the creation of this plan and continues to participate in annual drills and meetings. The San Francisco Marine Exchange is working in partnership with the Coast Guard to perform the administrative requirements of SF-VMAP.

**Outreach.** VTS personnel spend many hours with people from various segments of the San Francisco Bay maritime community to learn about mariners’ concerns and to educate mariners on how VTS can assist them. VTS personnel have been active participants on the Prevention through People Work Group, the Tug Escort Work Group, the Ferry Operations Work Group and the Navigation Work Group. Outreach efforts also have included many non-traditional stakeholders in the Bay area, such as the California Department of Transportation bridge engineers responsible for overseeing the various seismic retrofit projects in progress throughout the Bay. VTS personnel also assist with USCG outreach in preparation for commercial fishing seasons.

**Marine Events.** San Francisco Bay has more permitted marine events than any other port or city in the United States. VTS has an active outreach program to the boating public, which includes meeting with various recreational boating organizations throughout the year. VTS works closely with other Coast Guard personnel and yachting organizations during the permit process to prevent recreational vessels from impeding commercial traffic. The Coast Guard hosts annual Marine Event Workshops aimed at educating event coordinators about commercial maritime traffic, Rule 9 of the Navigation Rules and VTS operations.

**VTS Ship Ride Program.** All VTS personnel are required to participate in approximately six ship rides and/or shore-side visits each year. This, by far, is the best method for direct, person-to-person contact with port stakeholders and the sharing of suggestions. The requirements cover almost all areas of the maritime community: piloted ships, tugs, ferryboats and shore facilities.

### **VTS Operations and Requirements**

Over the years since the inception of VTS San Francisco, the Coast Guard has periodically identified the need for upgrading VTS equipment to include state-of-the-art technology. VTS' system of tracking vessels by computer was initially installed in 1997. In 2000, the software and hardware were upgraded, and a renovation of VTS' communications system was completed. This communication system upgrade involved replacing radios at each of the VTS' high sites, converting them from an analog to a digital microwave system and installing a new radio control system. In December 2004, VTS was upgraded with Automatic Identification System antennas and software.

## **XIV. Tug Escort / Assist for Tank Vessels**

The following section provides a history of the evolution of Tug Escorting for Tankers within San Francisco Bay with some updated information. Current requirements pertaining to escort tugs can be found in:

TITLE 14, CALIFORNIA CODE OF REGULATIONS  
 SUBDIVISION 4. OFFICE OF SPILL PREVENTION AND RESPONSE  
 CHAPTER 4. VESSEL REQUIREMENTS  
 SUBCHAPTER 1. TANK VESSEL ESCORT REGULATIONS FOR THE SAN FRANCISCO BAY REGION

### Sections

"851.8 Requirements for Escort Tugs; Braking Force Measurement, Crew and Training Standards, Equipment and Stationing Criteria."

"851.9 Tanker and Tug Matching Criteria, and Tanker Crew and Equipment Requirements"

"851.9.1 Barge and Tug Matching Criteria, and Barge Crew and Equipment Requirements"

<https://nrm.dfg.ca.gov/FileHandler.ashx?DocumentID=22000&inline>

In 1990, Senate Bill 2040 (the Oil Spill Prevention and Response Act) established that tug escorting was beneficial for tanker operations and directed expeditious development of escorting regulations for San Francisco Bay. The requirement is based on the legislative finding that there is a navigational safety advantage of tug escorts. Tug escorts can improve tanker safety in at least two ways. Tug escorts can serve as emergency maneuvering aids in the event of loss of steering or propulsion, and a tug escort may also assist as an independent aid in the navigation of a tanker.

The Final Report of the States/British Columbia Oil Spill Task Force (1990) concluded that the risk of an oil spill could be reduced by eight to 11 percent with the mandatory use of tug escorts. That report, endorsed by the State of California, suggested that the escorts be highly maneuverable, have speed complementary to the tanker with sufficient power to control tanker direction, and that the power and number of escort tugs should be proportionate to the deadweight tonnage of the tanker.



The Harbor Safety Committee (HSC) established a Tug Escort Subcommittee, which created Interim Guidelines for tug escorting in San Francisco Bay. The Interim Guidelines recommended: minimum requirements for tug escort equipment and crews; a formula for matching tugs to tankers; establishing a central Clearing House to measure bollard pull and monitor and document compliance with the regulations; setting tug escort zones in the Bay; and various operational considerations. OSPR caused emergency regulations to be established in the winter of 1992 based on the Interim Guidelines.

In the spring of 1993, the HSC adopted a revised set of Permanent Guidelines to supersede the emergency regulations. The Permanent Tug Escort Guidelines differed from the Interim Guidelines in a number of significant respects. The Permanent Guidelines altered the formula for matching tugs to vessels by changing the bollard pull formula from ahead static bollard pull equal (or greater) than the dead weight tonnage of a regulated vessel to the astern static bollard pull in the same ratio. Additionally, performance standards for stopping a tanker; equipment standards and inspection of tugs; positioning of regulated vessels; and training requirements for tug escort crews were established. During the State's administrative process, OSPR chose to reject the permanent guidelines on the basis of their lack of rationale and scientific basis for matching tugs to tankers.

The subcommittee began what grew into a two-year process of preparing a scientific study of how to match escort tugs to tankers, with the assistance of a consultant and by holding extensive public hearings on the results of the study. Based on state funding concerns and time limitations, industry volunteered to engage a consultant in conjunction with an industry-based Technical Advisory Group and the Tug Escort Subcommittee acting as a policy board. Glosten Associates was hired to prepare a professional study focusing on the specifics of tug escorting on San Francisco Bay. Additionally, the State funded a peer reviewer, Michael M. Baristas of the University of Michigan, to review the consultant's work and to mitigate concern regarding bias. Their reports were completed in the winter of 1994.

The Glosten Study had adopted a dual-failure standard (the simultaneous loss of both propulsion and steering) as the basis for measuring the force (tanker demands) required to recover from the tanker machinery failure and remain within the tactical area of performance. Further, the tactical area was based on the ninety-fifth percentile of success in stopping the tanker within the available reach and transfer. After review of the enabling scope of work and industry concerns regarding the likelihood of a dual failure and the attendant tanker demands, the dual standard was thought to be unreasonable. The subcommittee set up various working groups to review failure probability, waterway characteristics, and commercial and navigational safety implications of demand standards and requested that Glosten calculate demands based on single failures.

These efforts resulted in a second Glosten Study and reports on failure probability and waterway specific characteristics. The subcommittee reviewed these reports and adopted a single failure standard for the development of matching criteria.

The process involved close involvement and participation by the interested public and OSPR. On August 10, 1995, the full Harbor Safety Committee reviewed and adopted the Tug Escort Subcommittee's guidelines on a vote of twelve to one. The HSC promptly transmitted the new guidelines and recommendations to OSPR for implementation.

The Committee publicly reviewed the regulatory language proposed by OSPR. During the review of the regulations, several issues were identified as not being in compliance with the Committee's recommendations. The most critical issues were related to the intended use of checklists to review and develop a transit-specific plan versus OSPR's new requirements that plans be filed with OSPR thirty days in advance. OSPR subsequently agreed to modify its proposed language to comply with the intent of the Committee's guidelines, which the Committee adopted in January 1996.

OSPR held a public hearing on the proposed permanent tug escort regulations on March 19, 1996. Approximately 15 people testified at the hearing. Most supported the new regulations but a sizable group protested the use of a single-failure standard instead of a dual-failure standard. Many of those who commented also suggested minor modifications to the regulations, such as individualized, company-specific check lists and reducing pilot liability. Written comments were also received.

In addition to the public hearing process on regulations, OSPR was required at the time by law to have regulations reviewed by the State Inter-Agency Oil Spill Prevention Committee, which reviewed and approved the regulations for implementation, and by the OSPR Technical Advisory Committee, which is purely advisory and has no approval or disapproval authority. The issue of dual- versus single-failure standard was again debated and it was concluded to continue with the single-failure standard.

The Tug Escort regulations became effective January 1, 1997. (See Appendices for current list of certified tug escorts, the current Clearing House Report on escorted vessel movements and for Amended Tug Escort Regulations.) There have been no significant issues in implementing the regulations.

It should be noted that the 1997 Tug Escort regulations require that:

The OSPR Administrator shall review the matching criteria and other program elements within two years of the effective date of this subchapter. The program review will include a survey of the tanker-related incidents in U.S. waters to determine the types of failures that have occurred, an assessment of tug technology and any advances made in design and power, and the tug escort organizations. At the conclusion of the review, the Administrator will determine whether it is necessary to modify the tug/tanker matching criteria or any other provision of the program requirements....

The OSPR review to determine whether any changes should be made to the tug/tanker matching formula met the January 1, 1999 deadline; however, the regulations did not require a report and none was prepared. Rather than conduct a review every two years, the HSC, on behalf of the Administrator, reviews incidents on an ongoing basis at its monthly meetings. If further evaluation is warranted, issues are referred to the appropriate Work Group for additional analysis. Any findings and recommendations are brought before the full Committee for discussion and vote.

Subsequently, in 2001-2002, the HSC Tug Escort Work Group initiated a “sunshine” review of the entire tug escort regulations for the San Francisco Bay Region. The Work Group met for a one-and-a-half year period. The meetings were well attended by representatives of tanker operators, tug operators, the San Francisco Bar Pilots, marine terminal operators, the U.S. Coast Guard, OSPR, State Lands Commission, the San Francisco Marine Exchange and a host of other local maritime professionals.

The cornerstone of the regulatory review was a thorough examination of the tug/tanker matching matrix. The Work Group met with Dr. David Gray, Naval Architect of Glosten Associates from the Seattle-based company that developed the original tug/tanker matching matrix. Dr. Gray reviewed the assumptions upon which the matching formula was based and the present mix of tankers that call in the Bay. After much deliberation, the Work Group concluded that the tug/tanker matrix remains valid and should not be modified (determination made at the January 15, 2002 Work Group meeting and reported to the HSC at its February 14, 2002 meeting).

**Training for Tug Escort Crews.** As a result of its study of the tug/tanker matching matrix, the Work Group determined that in order for tug escorts to be effective in an emergency, training of escort tug and ship crews under pilot direction should be addressed. The Work Group concluded that training exercises could not be mandated by regulation, as the training exercises must be individual to the tugs and vessels because of the wide variety of tankers, barges and tugs and variety of conditions on the Bay. The Work Group prepared guidelines entitled “Recommendations for Conducting Escort Training on San Francisco Bay,” which outlines procedures for tug and ship crews, as well as pilots, to participate in live training exercises under agreed-upon, non-emergency conditions. A draft of the Recommendations was circulated to various tug, tanker, and barge companies and to the S.F. Bar Pilots.

The Committee adopted the guidelines on May 9, 2002 (see Appendices). The HSC Secretariat, through the Marine Exchange, then sent a letter to all affected parties in the maritime community, encouraging companies to adopt the Recommendations. The Tug Escort Work Group reports that tug escort emergency maneuvers are being conducted on a voluntary basis in accordance with the HSC’s Recommended Guidelines.

In September 2008, the Tug Escort Work Group was given a presentation of a Simulator Training Program for Tugs and Pilots that is being used in Puget Sound for tug captains, Puget Sound Pilots and B.C. Pilots. Over the years it has become evident that the opportunity for on-the-water exercises involving tankers and tugs has been extremely limited at best, with few individuals trained for actual events. However, with maritime simulators becoming more sophisticated in their ability to replicate a variety of situations and with a California Maritime Academy (CMA) simulator operational within a few months, the Work Group decided to explore the opportunity for simulating local conditions on a cost-effective basis to the maritime community within the San Francisco Bay Area.

The Work Group concluded that in addition to promoting simulator training for tugs escorting tankers, simulator training is applicable to tugs assisting and docking container ships, bulk carriers and chemical ships – thus providing industry-wide benefits for safe navigation.

The Harbor Safety Committee encourages the maritime industry to provide simulator training for tug personnel with pilot participation for emergency tug operations, based on local conditions. The training will improve communication between pilots and tug masters, offer in-house training to tug industry personnel, and provide valuable “lessons learned” for emergency situations in a controlled environment.

**Training Update.** At the inception of escort regulations tractor tugs were just beginning to be introduced in San Francisco Bay. Many of the maneuvers that a tractor tug could perform to help reduce speed or steer a tanker were innovative. As tractor tugs have become the dominant escorting tug these maneuvers have become common practice among all escorts and now are incorporated during normal assists performed on tankers and non-tank vessels. For example, arresting maneuvers to reduce speeds are practiced on many container ships entering the port of Oakland. The training that in the past would require a full-scale drill is now accomplished during everyday operations.

In addition to on water training, companies are making extensive use of simulators to address training in their Safety Management Systems. Often this training will incorporate all other industry segments so that there are pilots, vessel operators, and tug crew in the simulator training together. Most facilities have dual simulators so that a tug operator can be in one simulator working with the pilot and the vessel crew in the other simulator. Industry has made use of these facilities to simulate tug/vessel interactions in common navigational areas and also made use of them to simulate interactions at terminals only in the design stage.

Training will continue to play a critical role in safe transits through San Francisco Bay.

## **XV. Pilotage**

Pilotage is of primary import to Bay shipping because of complex local conditions consisting of narrow navigation channels, many bridges, swift tides and currents, variable weather patterns, and large numbers of ships and small vessels. For more than one-hundred-fifty years, the State has regulated pilotage over the Golden Gate bar through the State Board of Pilot Commissioners, which was created in 1850.

**San Francisco Bar Pilots.** This category of pilots is also referred to as Bar Pilots. A state license is required for a Bar Pilot to handle vessels entering the Bay and operating inside the Bay. A federal pilot's license is also required. The State Board of Pilot Commissioners regulates the number, licensing, training and disciplining of Bar Pilots for the Bays of San Francisco, San Pablo and Suisun.

**Federal Pilots.** Federal pilots are licensed by the U.S. Coast Guard to handle U.S. flag vessels under enrollment. State licenses for these pilots are not required.

**Ports of Stockton and Sacramento.** The Ports of Stockton and Sacramento have separate pilotage authority from the Board of Pilot Commissioners. In practice, these ports issue commissions to certain pilots licensed by the state.

**Docking Pilots.** Section 1179 of the Harbors and Navigation Code allows shipping companies who expressed their intent to the Board of Pilot Commissioners before July 1, 1983, to have their own employees used as pilots in lieu of Bar Pilots. In the Bay, a grandfathering clause allows one shipping company to use its own employee(s) who are not subject to State Board of Pilot Commission regulations as pilots for docking. These employees are federally licensed.

**Harbors and Navigation Code Preventing Unlicensed Person from Performing Pilotage.** State legislation requires the use of pilots on San Francisco Bay and provides penalties to prevent unlicensed persons from performing pilotage. The penalty for acting as a pilot while not holding a pilot license was increased to a maximum of \$25,000 (Harbors and Navigation Code Section 1126).

## **XVI. Underkeel Clearance**

Many of the navigation channels within the purview of the Harbor Safety Plan are subject to shoaling due to the nature of the Bay estuarial system, which is more fully described in Chapter V, Surveys, Charts and Dredging. Accurate tidal information is essential in order to calculate the recommended underkeel clearance for a safe vessel transit. This is particularly critical as frequently there are significant variances of depth in certain channels. The Harbor Safety Committee reiterates the importance of utilizing and supporting the “real time” accurate measurement of tides, such as NOAA’s PORTS, which is recommended in Chapter II, General Weather, Tides and Currents.

Underkeel clearance is the distance between the deepest point on the vessel and the bottom of the channel in still water conditions. The below listed underkeel clearances are minimum standards recommended during normal, calm conditions.

Vessels should adhere to the following guidelines for the minimum static underkeel clearance.

- A. Vessels under way west of the Golden Gate Bridge: No less than ten percent (10%) of the vessel’s draft
- B. Vessels under way east of the Golden Gate Bridge: No less than two (2) feet.
- C. Vessels at final approach to berth and at berth: Always afloat.

Masters and pilots should use prudent seamanship and should evaluate the need for additional clearance to accommodate the effects of roll, list, pitch and squat.

## **XVII. Economic and Environmental Impacts**

The Harbor Safety Plan must identify and discuss the potential economic and environmental impacts of implementing the provisions of the plan, and describe the significant differences in the restrictions that could vary from port to port within the geographic boundaries of the plan.

**Economic Impacts.** In order to make an economic assessment of the impacts of implementing the plan, recommendations that have a cost implication are identified with their potential economic impact. The following recommendations have a direct cost and an economic impact:

**Tides and Currents.** Federal, State and/or local funding is necessary for the USACE to conduct frequent, up-to-date surveys of major shipping channels and turning basins, and for the San Francisco Marine Exchange to operate and maintain the PORTS system.

**Harbor Depths, Channel Design and Dredging.** Conducting comprehensive annual condition surveys noting depths alongside and at the head of their facilities would be a cost for each facility owner or operator. Conducting more frequent, up-to-date surveys of channels known to shoal rapidly (i.e. Pinole Shoal Channel and Bulls Head Channel) would require an allocation of funds from the USACE and/or NOAA.

**Bridge Management.** The cost of installation and maintenance of energy absorbing fendering systems, bridge clearance gauges, water level gauges at bridge approach points, navigational lighting and racons on bridges over navigable waterways, where needed, would be borne by the individual bridge owners and operators such as the Union Pacific Railroad, Caltrans and the Golden Gate Bridge District.

**Tug Escorts.** The cost of tug escorts and standby tugs for ships and barges underway carrying more than 5,000 long tons of oil bulk as cargo in tug escort zones defined in the plan are directly borne by the shipper.

**Pilotage.** Future recommendations for pilotage may have cost implications.

**Small Vessels.** Federal, State and/or local funding is necessary to maintain and enhance the publication and distribution of pamphlets, brochures, videos, signs and other materials to increase boater education on shipping lanes, rules of navigation and safety guidelines for recreational boaters operating smaller vessels.

Each of the recommendations listed above has a cost that would be incurred by a commercial operator, port facility or government agency if that recommendation were implemented. To that extent, these would be economic impacts of the Harbor Safety Plan. Generally these items of cost are either capital items (such as new navigational equipment on bridges) or additional duties for an established agency.

The economic impact of the Harbor Safety Plan appears to fall equally on government agencies and private industry. The USACE, NOAA, bridge owners and operators, and each port and facility operator would be required to spend money to improve facilities they own or operate in order to meet the recommendations of the Harbor Safety Plan. In addition, private industry would be required to meet the cost of escort tugs and possible increased pilotage.

**Differences in Restrictions from Port to Port.** Seven ports are within the geographic boundaries of the Harbor Safety Plan: San Francisco, Oakland, Richmond, Redwood City, Benicia, Sacramento and Stockton. Nothing in this plan would create an advantage for any one of these ports as compared to any other port within the plan area.

### **Environmental Impacts**

San Francisco Bay is a unique geographical area. It is the largest estuary on the Pacific Coast between Alaska and the tip of South America, with a shoreline, including sloughs, certain waterways and islands, of approximately 1,000 miles. Sixty-five percent of the rain and snowfall in California drains into rivers and creeks that feed the Bay.

Because of its size, depth and shelter from the open ocean, San Francisco Bay is a major harbor. Reflecting the trend in total U.S. commodities, a large percentage of the material shipped through the harbor is petroleum. The Bay presents a number of challenges to navigation, such as shallow waterways, narrow shipping lanes, vessel traffic, strong tides and currents, and occasional bad weather conditions, such as dense fog and strong winds. The Harbor Safety Plan has increased the level of navigational safety for the San Francisco Bay region, including the Ports of Sacramento and Stockton.

A major oil spill in the Bay would cause millions of dollars in damage to the marine environment, adversely affecting a variety of natural resources including wildlife habitats, water quality, commercial and recreational fishing, recreational areas, in addition to affecting human safety, marine businesses and personal property. (The 2007 *Cosco Busan* oil spill resulted in a settlement of \$44.4 million for natural resource damages and penalties and reimbursement of governmental entities for response costs incurred.) San Francisco Bay is part of the Pacific Flyway; in the winter months over one million birds use the area, which could be severely impacted by a sizeable oil spill. The wetlands, tidal flats, and open water of the San Francisco Bay Estuary provide essential habitat—food, water, shelter and other benefits—for over 500 species of fish, amphibians, reptiles, birds and mammals. A number of these species are threatened or endangered. In addition, there are almost as many invertebrate species in the ecosystem as all other animals combined, bringing the total number of species that use the Estuary to over 1,000. Just outside the Golden Gate, several marine sanctuaries protect some of the most productive coastal waters in the world. Spilled oil and certain cleanup operations can threaten the different types of marine habitats and other Bay resources.



As mentioned above, the Harbor Safety Plan has increased navigational safety throughout San Francisco Bay, thereby reducing the likelihood of a maritime accident that could result in the spill of a hazardous material, such as oil. Further, the Harbor Safety Committee, composed of representatives from the maritime community, port authorities, pilots, tug operators, the U.S. Coast Guard, the Office of Spill Prevention and Response, the petroleum and shipping industries, recreational boaters, the USACE and others with expertise in shipping and navigation, regularly meet to develop additional strategies to further safe navigation and oil spill prevention and to update the Harbor Safety Plan accordingly. As such, the Harbor Safety Plan has an overall beneficial impact on the environment since it furthers navigational safety and oil spill prevention, thereby helping protect the Bay from the adverse environmental impacts of a potential oil spill.

## **XVIII. Plan Enforcement**

The Oil Spill Prevention and Response Act (Act) provides for the Harbor Safety Committee to suggest mechanisms to ensure that the provisions of the Harbor Safety Plan be fully, uniformly and regularly enforced. Traditionally, the U.S. Coast Guard has been responsible for the regulation of vessel movements and inspections through the authority vested with the Captain of the Port. Within the geographic boundaries of the Harbor Safety Plan, almost all oil terminals are privately operated and outside of the jurisdiction of local port authorities. The USCG also has been the mainstay of enforcement within the plan boundaries, and it is expected that it will continue in this role.

Under the Act, the State Lands Commission and the California Department of Fish and Wildlife are granted dramatically increased roles and enforcement responsibilities. The State Lands Commission inspects facilities and vessels that are moored alongside the above-mentioned privately operated terminals, and monitors the cargo transfer operations. In the event of a violation, the appropriate state or federal agency is notified. The Department of Fish and Wildlife enforces state regulations under the Act and monitors vessel bunkering operations along with the Coast Guard, and has the power to impose criminal and civil penalties for violations.

Tug Escorts are monitored by the Clearing House (CH), which was established to monitor the tug escort program for the Department of Fish and Wildlife. The Marine Exchange of the San Francisco Bay Region administers the CH. The CH will confirm that all applicable tankers are escorted by an appropriate tug, and that the escort tug is on station prior to the movement of the vessel. In the event that the tug is not on station, the CH contacts the pilot, the master of the vessel, and the shipping company and/or agent and advises them accordingly. The vessel may not proceed until the escort tug is on station. The CH notifies the Department of Fish and Wildlife of suspected violations. In the event that the tug breaks down during an escort, the master and the pilot will determine the safest course of action: whether to stop, to return to dock or to proceed.

Review and update of the Harbor Safety Plan is mandated to take place annually on or before July 1. At that time, all aspects of the Harbor Safety Plan are assessed and the findings and recommendations for improvements are sent to the Administrator.

### **Coordination of Enforcement Responsibilities**

The Coast Guard and the Department of Fish and Wildlife coordinate policies and procedures to the greatest extent possible with each other and with other federal, state, and local agencies. Cooperation and coordination between agencies minimizes enforcement efforts required for all federal, state, and local regulations. This cooperation is essential since, relative to the Harbor Safety Plan, the Coast Guard is the primary enforcement agency for federal regulations, and the Department of Fish and Wildlife is the primary enforcement agency for state regulations.

## **XIX. Recommendations Implemented or Addressed**

The Harbor Safety Committee, through its work groups, adopted the following recommendations to reduce the risk of oil spills in the San Francisco Bay Region. The respective chapter of the Harbor Safety Plan includes background discussion of the issues addressed by each recommendation. The following recommendations have been implemented by the responsible agency.

### **I. Geographical Boundaries**

No recommendations.

### **II. General Weather, Tides and Currents**

No recommendations.

### **III. Aids to Navigation**

No recommendations.

### **IV. Anchorages**

It was recommended that the USCG adopt pre-designated anchorage areas within the existing general anchorages throughout the VTS SF area, and in particular within General Anchorage 9, so that VTS SF may manage safer and more disciplined anchoring practices. The final resolution was to divide the anchorage into two areas: the western side has been designated for deep-draft vessels and the eastern side for lighter-draft vessels. In addition, VTS requires that vessels not anchor closer than 750 yards from one another.

### **V. Harbor Depths, Charts and Dredging**

1.a. The recommendation to “establish a new two-way Traffic Separation Scheme north of Alcatraz to allow safer navigation of deeply laden tankers” has been implemented, and is now referred to as the “Deep Water Traffic Lane.” (Date established: 1992)

1.b. The recommendation requesting the Corps of Engineers to further evaluate the lowering of Harding, Arch, Shag and Blossom Rocks has been implemented. The USACE determined that there was not a Federal interest in pursuing a structural alternative (physically lowering some or all of the rocks) as a result of the Feasibility Study for the proposed project. No further action. (See Ch. V, section on Navigational Issues Associated with Channel Design and Dredging.)

2. The recommendation to eliminate the dogleg at buoy “C” of the San Rafael main ship channel to maintain proper two-way traffic separation” has been addressed. This action was evaluated and found cost prohibitive. (Date addressed: 1993)

## **VI. Contingency Routing**

No recommendations.

## **VII. Vessel Speed and Traffic Patterns**

For the San Francisco main ship channels from the COLREGS Demarcation Line to and between the southern tip of Bay Farm Island and the Dumbarton Railroad Bridge:

- a) The maximum speed for all power driven vessels of 1,600 or more gross tons shall not exceed 15 knots through the water from the COLREGS Demarcation Line to and between the southern tip of Bay Farm Island and Dumbarton Railroad Bridge; and
- b) Power-driven vessels of 1,600 or more gross tons shall in any case have their engines ready for immediate maneuver and shall not operate in control modes or with fuels that prevent an immediate response to any engine order ahead or astern or preclude stopping their engines for an extended period of time.

## **VIII. Accidents and Near-Accidents**

The HSC adopted a definition of a reportable ‘Near Miss’ situation to standardize reporting along the California Coast. However, after consulting with the other California Harbor Safety Committees, the idea to establish a systematic reporting of a ‘near miss’ was abandoned because of the issue of potential liability by the reporting party. The USCG considered a program to address non-reportable near casualties on a national and international level, but put the program on hold in November 2002 because of lack of funding. (Date addressed: 2002)

## **IX. Communication**

1. The recommendation to alleviate congestion on Channel 13 was implemented when the USCG shifted the primary VTS channel to Channel 14. The Harbor Safety Committee endorsed the Coast Guard’s efforts to improve the existing system. (Date addressed: 1994)

2. The Harbor Safety Committee recommends the acquisition of adequate backup power supplies for the San Francisco Bar Pilots and San Francisco Marine Exchange communications systems. At a minimum, portable diesel generators obtainable commercially should be procured and arrangements made to provide means of powering minimal lighting and communications circuits.

**X. Bridges**

1. Bridge clearance gauges should be installed where needed, particularly drawbridges. (Note: USCG requires bridge clearance gauges. Please notify CG District 11 Bridge Administration of any discrepancies.)
2. Water level gauges should be installed at approach points to bridges. (Note: Water level gauges are not under the jurisdiction of the USCG. However, proposals to install gauges or other items on bridges will require permission from the bridge owner, followed by review and approval from the CG District 11 to ensure permitted bridge structures are not altered without approval.)
3. Request the Golden Gate Bridge Highway and Transportation District to install a RACON (radio beacon) to mark the center of the channel between the towers of the Golden Gate Bridge to better serve the mariner, particularly during periods of restricted visibility and heavy seas. (Note: RACONS were installed some time ago. Please notify CG District 11 Bridge Administration of any discrepancies.)
4. Request the Department of Transportation (Caltrans) to install racons on the D-E span of the San Francisco-Oakland Bay Bridge (instead of the G-H span), and the A-B span because the spans vary in height and width and currents can reach considerable velocities running parallel to the towers. (Note: RACONS were installed some time ago. Please notify CG District 11 Bridge Administration of any discrepancies.)
5. Request Caltrans and the Golden Gate Bridge District to shield bridge floodlights to reduce the glare for ships. (Note: Completed)

**XI. Small Passenger Vessels – Ferries**

1. The Ferry Operations Work Group recommends that the ferry routes developed by the Work Group working with ferry operators, captains and the VTS, be adopted by the Harbor Safety Committee and incorporated into the Harbor Safety Plan.
2. The Work Group further recommends the HSC work with NOAA to include the routes and accompanying notes on area nautical charts. (Date established: May 2008)

**XII. Small Vessels**

1. Pilots, Masters, and other interested parties should be invited to witness a series of races from the St. Francis Yacht Club race deck to obtain a view of events from the competitors' level.
2. The Yacht Racing Association of San Francisco Bay should furnish full annual race schedules to all interested shippers, and, in particular, the Harbor Safety Secretariat for distribution.

5. The Yacht Racing Association should furnish optional courses and rounding marks used by participating entities. The race committee for each day's event should choose a course compatible with anticipated large vessel traffic.
6. The Coast Guard Auxiliary should observe and report infractions. The U.S. Coast Guard suggested that a mailer be prepared, to be inserted with vessel license renewal notices, advising owners of Inland Steering and sailing rules, Rule 9.
7. Expand the distribution of existing educational pamphlets available from the U.S. Coast Guard. These pamphlets provide information regarding the above-mentioned courses and the phone number for the Boating Education Hotline at (800) 336-2628 that would provide information regarding the scheduling of these classes. Distribute these educational pamphlets by: enclosing them in the boat registration renewal notices sent to boat owners by the Department of Motor Vehicles in the State of California (a follow-up mailing might also be considered to remind boat owners of these courses); enclosing them in local boat marina mailings to slip renters; requesting marinas to offer a one-time slip rental rebate for completion of a safe boater course.
8. Encourage vessel operators to document and report violations of the Rules of the Road to the local U.S. Coast Guard office. This would include a direct request to the San Francisco Bar Pilots to assist in this reporting effort.
9. Make public by publishing punitive actions taken against offenders by the U.S. Coast Guard. This information should be distributed to local yachting and boating magazines and marina newsletters. In addition, the California Department of Motor Vehicles should distribute a summary of punitive activities to registered boat owners.
10. Encourage the ongoing efforts of the local U.S. Coast Guard Auxiliary and Power Squadron organizations in their boating education and safety efforts.

### **XIII. Vessel Traffic Service**

1. Scope of Coverage
  - a. Develop standard VTS traffic management procedures for U.S. ports that conform to international standards.
  - b. Make mandatory for civilian and military vessels the current voluntary participation in VTS and extend required participation to include vessels certified to carry 49 passengers or more (i.e., ferries).
  - c. Incorporate the provisions of International Rule 10 in the federal regulations regarding VTS.

- d. Expand the area of sensor coverage by VTS SF to monitor the navigable waters of San Pablo Bay north of the San Rafael-Richmond Bridge and east of the Carquinez Straits to New York Point and Antioch. It is anticipated by this committee that San Pablo Bay may be covered by radar surveillance alone while television monitors, in addition to radar, may be needed in the area of the Strait where continuous change of heading could make radar monitoring alone difficult. Sensor coverage expansion has been repeatedly requested.
2. Changes in VTS Operations and Requirements
    - a. Adopt a dedicated VHF working frequency, Channel 14, for the exclusive use of VTS SF ship/shore communication system. Channel 13 should continue to be monitored and used for ship/ship communications.
    - b. Upgrade the current equipment used by VTS SF to include state-of-the-art technology (U.S. Coast Guard, *Port Needs Study: Vessel Traffic Services Benefits*, Volume I: Study Report and Volume II, Appendices, Part 2).
  3. The Harbor Safety Committee supports continued federal funding for VTS San Francisco in order to ensure navigational safety in the San Francisco Bay Area.

#### **XIV. Tug Escort/Assist for Tank Vessels**

Over a period of five years, the Harbor Safety Committee took the following steps to establish tug escorting in the Bay:

- 1) Adopted Interim Tug Escort Guidelines in 1992.
- 2) Adopted Permanent Tug Escort Guidelines in 1993.
- 3) Adopted Revised Permanent Tug Escort Guidelines in 1995.
- 4) Amendments to Revised Permanent Guidelines Adopted January 1996 (Revised tug escort regulations effective January 1, 1997).
- 5) Recommended establishing a technical pilotage committee to review waterways specific maneuvers of tankers and tugs.

#### **XV. Pilotage**

1. The recommendation that the California Harbor and Navigation Code be amended to add requirements for shipping company employees eligible to pilot vessels in the Bay Area has been addressed by State and Federal regulation. (Date addressed: 1996)

2. The recommendation that Coast Guard regulations be amended for pilotage has been deleted as not under the purview of the Harbor Safety Committee.
3. The recommendation that the Board of Pilot Commissioners work with the San Francisco Bar Pilots to incorporate in the Pilot training program enhanced training in advanced electronic navigation systems, providing exposure to a greater number of systems and variety of presentations has been implemented. (Date addressed: 2008)
4. The recommendation that the Board of Pilot Commissioners adopt a regulation to require that pilots licensed by the Pilot Commission be equipped with, and trained in the use of, portable electronic navigation equipment, commonly known as Portable Pilot Units ("PPUs"). The regulation should require that pilots be equipped with PPU's at all times while piloting except when the pilot deems that embarking on or disembarking from a vessel while carrying a PPU may present an unacceptable safety hazard to the pilot or when circumstances would prevent its use. (Date addressed: 2008, [Title 7 CCR Section 219\(y\)](#))

Such PPU's shall, at a minimum, have the following capabilities:

- (a) Displaying approved electronic navigation charts (ENCs) issued by the cognizant U.S. government authority;
- (b) Displaying the vessel's position and heading on such ENCs to the accuracy required by the International Maritime Organization (IMO) for Automatic Identification Systems (AIS); and
- (c) Displaying other navigational information as provided through the vessel's AIS pilot plug.

## **XVI. Underkeel Clearance**

1. The recommendation that guidelines for underkeel clearances of vessels carrying oil or petroleum products as cargo or as fuel be established has been implemented by establishing the following minimum static underkeel clearances in normal, calm conditions:

- Vessels west of the Golden Gate Bridge: No less than ten percent (10%) of the vessel's draft.
- Vessels under way east of the Golden Gate Bridge: No less than two (2) feet.
- Vessels at final approach to berth and at berth: Always afloat.

Masters and pilots should use prudent seamanship and should evaluate the need for additional clearance to accommodate the effect of roll, list, pitch and squat.

## **XVII. Economic and Environmental Impacts**

No recommendations.



**XVIII. Plan Enforcement**

The Coast Guard and the State Department of Fish and Wildlife should coordinate policies and procedures to the greatest extent possible with each other and with other federal, state, and local agencies.

**XIX. Substandard Vessel Inspection Program**

Support the U.S. Coast Guard vessel inspection program of targeting substandard vessels in the Bay.

**XX. Harbor Safety Committee Educational Materials**

The Harbor Safety Committee has produced a number of educational materials in an effort to increase safe use of the Bay. Copies of the following are available by contacting the San Francisco Marine Exchange at 415.441-6600.

*Your Guide to Recreational Marine Radio Communications for San Francisco Bay.* Brochure. July 2001.

*Where The Heck Is Collinsville?* Brochure. February 2002. Revised February 2008.

*Mariners, Do You Speak Channel 14?* Brochure. April 2003.

*Sharing the Bay.* Video, also available in CD and DVD format. Early 2004.

*Rules 9 & 5...Laws To Live By.* Brochure. May 2004.

*P.O.R.T.S. (Physical Oceanographic Real-Time System)* Brochure. December 2004.

*Kayakers, Be Alert!* Safety Sticker. April 2006.

*Knowledge for Novice Boaters.* Laminated safety placard. January 2007

*Stop Mayday Hoax Calls.* Laminated poster for USCG. January 2009.

## Appendix A

### Best Maritime Practices

The five California Harbor Safety Committees are directed by OSPR to adopt and incorporate into the individual Harbor Safety Plans, Best Maritime Practices (BMPs) to ensure that vessels in transit will be aware of the guidelines of operation in the state’s harbors. These guidelines, summarized in this section, provide important information necessary for safe, reliable and environmentally sound vessel movements in and around San Francisco Bay. The BMPs also are available on the Marine Exchange website: [www.sfmex.org/support/hsc/hscbestpractices.php](http://www.sfmex.org/support/hsc/hscbestpractices.php).

<b>INDEX - Best Maritime Practices</b>	<b>Page No.</b>
<b>LARGE VESSELS, TUGS with TOWS <math>\geq</math>1600 Gross Tons, and All Tugs with Tows in Petroleum Service</b>	
<a href="#">Speed Restrictions on San Francisco Bay</a> .....	75
<a href="#">Guidelines for Navigating in Reduced Visibility</a> .....	76
<a href="#">Guidelines for Navigating in Severe Weather</a> .....	78
<b>TUGS with TOWS &lt;1600 Gross Tons Not in Petroleum Service</b>	
<a href="#">Guidelines for Navigating in Reduced Visibility</a> .....	80
<a href="#">Guidelines for Navigating in Severe Weather</a> .....	82
<b>ESCORT TUGS</b>	
<a href="#">Emergency Training for Tug Escorting</a> .....	82
<b>SMALL PASSENGER VESSELS - Ferries</b>	
<a href="#">Guidelines for Navigating in Reduced Visibility and Severe Weather</a> .....	83
<a href="#">Traffic Routing Protocols (with route diagrams)</a> .....	85
<b>BUNKERING</b>	
<a href="#">Communication Procedures to Improve Safety During Bunker Barge Transfer Operations</a> .....	94
<a href="#">Safe Bunkering Operations Alongside Oakland Berths 35, 37 and 55-59</a> .....	98
<a href="#">Statewide Best Bunkering Practices</a> .....	99
<b>ANCHORAGES 7-9 BERTHING PROTOCOLS</b> .....	112
<b>DEAD SHIP TOWS</b> .....	115
<b>EMERGENCY OFFSHORE TOWING</b> .....	118

## Appendix A

**General Guidelines for All Vessels.** The following guidelines should be used by the mariner when planning, initiating or transiting on the navigable waters of the San Francisco Bay and Delta Region. Nothing in this guidance precludes vessel Masters, Pilots, and operators from taking proactive measures to ensure the safety of their vessel at all times.

Mariners are at all times to comply with the requirement of the International Regulations for Avoiding Collisions at Sea, or COLREGS.

**Critical Maneuvering Areas (CMA).** Critical Maneuvering Areas (CMA) are locations within the San Francisco Bay and Delta Region where additional standards of care are required due to the restrictive nature of the channel, proximity of hazards, or the prevalence of adverse currents. The dynamic and unpredictable nature of visibility conditions in the San Francisco Bay can introduce uncertainty and additional risk when transiting these areas.

### **Large Vessels, Tugs with Tows $\geq$ 1600 GT and All Tugs with Tows in Petroleum Service: Speed Restrictions on San Francisco Bay**

**Large Vessels** are power driven vessels of 1600 gross tons or more, tugs with tows of 1600 gross tons or more, and all tugs with tows in petroleum service. Specific areas where a **15 knot speed limit** applies within the San Francisco Bay region are prescribed in 33 CFR 165.1181:

- Golden Gate Traffic Lanes, which include the westbound and eastbound lanes west of the Golden Gate Precautionary Area
- Golden Gate Precautionary Area
- Central Bay Traffic Lanes, which include the Deep Water Traffic Lane, the eastbound lane (south of Alcatraz Island) and the westbound lane (south of Harding Rock)
- Central Bay Precautionary Area
- North Ship Channel between North Channel Lighted Buoy “A” and the Richmond-San Rafael Bridge
- Southampton Shoal Channel including the Richmond Long Wharf maneuvering area
- Richmond Harbor Entrance Channel
- Oakland Harbor Bar Channel including the Outer and Inner Harbors Entrance Channels
- San Pablo Strait Channel
- Pinole Shoal Channel

## Appendix A

- Benicia-Martinez Railroad Drawbridge

Additionally, power driven vessels of 1,600 or more gross tons shall have their engines ready for immediate maneuver and shall not operate in control modes or with fuels that prevent an immediate response to any engine order ahead.

**Note:** In instances where a slower speed than the 15 knot RNA limit is required for safe navigation, the COLREGS will prevail.

See Harbor Safety Plan Chapter VII: Vessel Speed and Traffic Patterns for discussion.

### **Large Vessels, Tugs with Tows 1600 Gross Tons or greater, and All Tugs with Tows in Petroleum Service: Guidelines for Navigating in Reduced Visibility**

**Applicability:** These guidelines apply to the following:

- Large Vessels (power driven vessels of 1600 gross tons or more)
  - Tugs with tows of 1600 gross tons or more
  - **All tugs with tows in petroleum service.**
1. Vessel Masters, Pilots and operators should at all times use proactive voyage planning to attempt to avoid CMAs during periods of reduced visibility.
  2. Vessels should not transit within a CMA when visibility is less than 0.5 nautical mile and should comply with the applicable CMA guidelines listed below.
  3. Vessels should expect delays at berth, anchor or sea if visibility in a CMA along their planned voyage is less than 0.5 nautical mile.
  4. Vessels should make visibility reports as part of their underway report to the VTS and at any point in their transit when visibility conditions change substantially and navigation safety allows the report to be made.
  5. Vessel masters, pilots or operators should notify VTS upon determination that a scheduled transit will be delayed or cancelled. If underway, they shall make a sailing plan deviation report per VTS regulations. Should a CMA-related delay introduce additional risks threatening the overall safety of the vessel or the port, then vessel Masters, Pilots, and operators are expected to proactively mitigate these risks through appropriate action and associated communication with VTS.
  6. All vessels which encounter unexpected visibility of less than 0.5 nautical mile within a CMA are advised to exercise extreme caution during the transit.

## Appendix A

7. **Vessels docked:** Vessels at a dock within the Bay should not commence a transit if visibility is less than 0.5 nautical mile at the dock.
8. **Vessels at anchor:** Vessels at anchor within the Bay should remain at anchor when visibility is less than 0.5 nautical mile at anchorage.
9. **Vessels proceeding to dock:** Vessels proceeding to a dock should anchor if visibility at the dock is known to be less than 0.5 nautical mile, unless, under all circumstances, proceeding to the dock is the safest option.

**The following ten locations within the San Francisco Bay and Delta Region are identified by the Harbor Safety Committee as Critical Maneuvering Areas (CMA). The specific guidelines listed below apply to Large Vessels, Tugs with Tows 1600 Gross Tons or greater, and all Tugs with Tows in Petroleum Service operating in each CMA:**

1. **Redwood Creek** :
  - Vessels should not transit through Redwood Creek when visibility is less than 0.5 nautical mile.
2. **San Mateo-Hayward Bridge:**
  - Vessels should not proceed southbound past San Bruno Shoal Channel Light 1 and Lighted Buoy 2 if the visibility is known to be less than 0.5 nautical mile at the San Mateo-Hayward Bridge.
  - Northbound vessels should not transit through the San Mateo – Hayward Bridge if visibility is less than 0.5 nautical mile.
3. **Islais Creek Channel** (inland from Lash Terminal Approach Lighted Buoy 2 and Lash Terminal Lighted Approach Buoy 5):
  - Vessels should not transit Islais Creek Channel when visibility is less than 0.5 nautical mile.
4. **Oakland Harbor Regulated Navigation Area (RNA):**
  - Vessels should not transit within the Oakland Harbor RNA (33CFR165.1181) when visibility is less than 0.5 nautical mile.
5. **The San-Francisco Oakland Bay Bridge (West of Treasure Island):**
  - Outbound/northbound vessels should not transit the San-Francisco Oakland Bay Bridge (West of Yerba Buena Island) when visibility is less than 0.5 nautical mile.
  - Vessels transiting the Bay Bridge CMA in any condition of reduced visibility should generally do so via the A-B or D-E span unless vessel traffic, environmental or other safety factors dictate otherwise.
6. **Richmond Inner Harbor (inland from Lighted Buoy 2):**

## Appendix A

- Vessels should not transit within Richmond Inner Harbor when visibility is less than 0.5 nautical mile.
7. **Richmond-San Rafael Bridge, East Span:**
    - Southbound vessels should not proceed past Point San Pablo if visibility is known to be less than less than 0.5 nautical mile at the East Span of the Richmond-San Rafael Bridge.
    - Northbound vessels should not enter Southampton Shoal Channel if visibility is known to be less than less than 0.5 nautical mile at the East Span of the Richmond-San Rafael Bridge.
  8. **Union Pacific Bridge (Benicia-Martinez Railroad Draw-Bridge):**
    - Large vessels must comply with the applicable regulations for the Benicia-Martinez Railroad Draw-bridge and RNA (33CFR165.1181e3).
    - Eastbound tugs and tows < 1600GT in petroleum service should not enter the Benicia-Martinez RNA if visibility is less than 0.5 nautical mile. If visibility reduces to less than 0.5 nautical mile at the UP Bridge after entering the RNA, vessels should not transit the bridge.
    - Westbound tugs and tows < 1600 GT in petroleum service should not proceed past Suisun Bay Channel Lighted Buoy 7 if visibility at the UP Bridge is less than 0.5 nautical mile.
  9. **New York Slough, up-bound:**
    - Vessels should not proceed past the “NY” buoy marking the entrance to New York Slough when visibility is less than 0.5 nautical mile.
  10. **Rio Vista Lift Bridge:**
    - Vessels should not transit the Rio Vista Lift Bridge when visibility is less than 0.5 nautical mile.

### **Large Vessels, Tugs with Tows 1600 Gross Tons or greater, and All Tugs with Tows in Petroleum Service: Guidelines for Navigating in Severe Weather**

A number of factors must be considered when limiting transits in the Bay or closing the Bar due to severe weather, including sea state, tidal influences, visibility, traffic density, and wind advisories issued by NOAA. The size, class and condition of the vessels being addressed must also be considered. The HSC recommends a tiered approach, applying greater caution as conditions worsen.

#### ***Sustained winds exceeding 25 knots in the Bay***

- Vessels should closely evaluate whether it is safe to transit in the Bay. Size, class and sail area of the vessel, tidal influences, visibility, and traffic density should all be considered.

## **Appendix A**

- VTS San Francisco will establish regular communications with bridge watches of VTS users in Bay Area anchorages, and more closely monitor swing circles to ensure vessels are not dragging.

### ***Sustained winds exceeding 40 knots in the Bay***

- Transits to and from berths are not recommended.

### ***Sustained winds exceeding 40 knots and/or seas exceed 12 ft at the Sea Buoy***

- Bar traffic restrictions and closure should be considered. Size and class of the vessel, draft, swell period, tidal influences, visibility, and traffic density should all be considered. Strong ebb tides should be avoided, and a minimum of 10 feet underkeel clearance is recommended.

### **Procedures for Closing the Bar or Restricting Bar Traffic**

- Bar closures are exercised on a situational basis without specifically defined weather or security conditions.
- The most recent San Francisco Bar Pilot over the Bar, inbound or outbound, shall make the recommendation to the dispatcher that the Bar should be considered for closure, or traffic limited to one-way traffic.
- In the event that the station boat is “boarded off”, then the station boat captain will make the recommendation to the dispatcher.
- The dispatcher will then notify the Operations Pilot, who will notify the Port Agent.
- The Operations Pilot or Port Agent will then notify the U.S. Coast Guard VTS and Command Duty Officer at the Sector San Francisco Command Center.
- The Captain of the Port will consult with the Operations Pilot or Port Agent prior to closing the bar under Captain of the Port authority. The Coast Guard will then issue a Marine Safety Broadcast communicating the closure or traffic restriction.
- The procedure for lifting traffic restrictions or re-opening the Bar will be the same as that for restricting traffic or closing the Bar.
- Vessels under Federal Pilotage or Public Vessel may petition the Captain of the Port to transit the San Francisco Bar.

Adopted January 2009. See Harbor Safety Plan Chapter II: General Weather, Currents and Tides for discussion.



## Appendix A

**Tugs with Tows less than 1600 Gross Tons Not in Petroleum Service: Guidelines for Navigating in Reduced Visibility.** (For Tugs with Tows < 1600GT in petroleum service, reference the Guidelines for Navigating in Reduced Visibility for Large Vessels.)

1. Vessel Masters, Pilots and operators should at all times use proactive voyage planning to attempt to avoid CMAs during periods of reduced visibility.
2. Vessels should comply with the applicable CMA guidelines listed below.
3. Vessels should expect delays at berth, anchor or sea if visibility in a CMA along their planned voyage is less than 0.25 nautical mile.
4. Vessels should make visibility reports as part of their underway report to the VTS and at any point in their transit when visibility conditions change substantially and navigation safety allows the report to be made.
5. Vessel masters, pilots or operators should notify VTS upon determination that a scheduled transit will be delayed or cancelled. If underway, they shall make a sailing plan deviation report per VTS regulations. Should a CMA-related delay introduce additional risks threatening the overall safety of the vessel or the port, then vessel Masters, Pilots, and operators are expected to proactively mitigate these risks through appropriate action and associated communication with VTS.
6. All vessels which encounter unexpected visibility of less than 0.25 nautical mile within a CMA are advised to exercise extreme caution during the transit.
7. **Vessels docked:** Tugs with Tows < 1600 GT at a dock within the Bay should not commence a transit if visibility is less than 0.25 nautical mile at the dock.
8. **Vessels at Anchor:** Tugs with Tows < 1600 GT at anchor within the Bay should remain at anchor when visibility is less than 0.25 nautical mile at anchorage.
9. **Vessels proceeding to dock:** Tugs with Tows < 1600 GT proceeding to a dock should anchor if visibility at the dock is known to be less than 0.25 nautical mile, unless, under all circumstances, proceeding to the dock is the safest option.

**The following ten locations within the San Francisco Bay and Delta Region are identified by the Harbor Safety Committee as Critical Maneuvering Areas (CMA). The specific guidelines listed below apply to all Tugs with Tows less than 1600 GT not in petroleum service operating in each CMA:**

1. Redwood Creek:
  - Tugs with Tows < 1600 GT should not transit through Redwood Creek when visibility is less than 0.25 nautical mile.
2. San Mateo-Hayward Bridge:

## Appendix A

- Tugs with Tows < 1600 GT should not proceed southbound past San Bruno Shoal Channel Light 1 and Lighted Buoy 2 if the visibility is known to be less than 0.25 nautical mile at the San Mateo-Hayward Bridge.
  - Outbound Tugs with Tows < 1600 GT should not transit through the San Mateo – Hayward Bridge if visibility is less than 0.25 nautical mile.
3. Islais Creek Channel (inland from Lash Terminal Approach Lighted Buoy 2 and Lash Terminal Lighted Approach Buoy 5):
    - Tugs with Tows < 1600 GT should not transit Islais Creek Channel when visibility is less than 0.25 nautical mile.
  4. Oakland Harbor Regulated Navigation Area (RNA):
    - Tugs with Tows < 1600 GT should not transit within the Oakland Harbor RNA (33CFR165.1181) when visibility is less than 0.25 nautical mile.
  5. The San-Francisco Oakland Bay Bridge (West of Treasure Island):
    - Outbound/northbound Tugs with Tows < 1600 GT should not transit the San-Francisco Oakland Bay Bridge (West of Yerba Buena Island) when visibility is less than 0.25 nautical mile.
    - Tugs with Tows < 1600 GT transiting the Bay Bridge CMA in any condition of reduced visibility should generally do so via the A-B or D-E span unless vessel traffic, environmental or other safety factors dictate otherwise.
  6. Richmond Inner Harbor (inland from Lighted Buoy 2):
    - Tugs with Tows < 1600 GT should not transit within Richmond Inner Harbor when visibility is less than 0.25 nautical mile.
  7. Richmond-San Rafael Bridge, East Span:
    - Southbound Tugs with Tows < 1600 GT should not proceed past Point San Pablo if visibility is known to be less than less than 0.25 nautical mile at the East Span of the Richmond-San Rafael Bridge.
    - Northbound Tugs with Tows < 1600 GT should not enter Southampton Shoal Channel if visibility is known to be less than less than 0.25 nautical mile at the East Span of the Richmond-San Rafael Bridge.
  8. Union Pacific Bridge ((Benicia-Martinez Railroad Draw-Bridge):
    - Tugs with Tows < 1600GT not in petroleum service should not transit the Union Pacific bridge if visibility is less than 0.25 nautical mile.
  9. New York Slough, up-bound:
    - Tugs with Tows < 1600 GT should not proceed past the “NY” buoy marking the entrance to New York Slough when visibility is less than 0.25 nautical mile.
  10. Rio Vista Lift Bridge:

## **Appendix A**

- Tugs with Tows < 1600 GT should not transit the Rio Vista Lift Bridge when visibility is less than 0.25 nautical mile.

Adopted February 2009. Amended February 2015. See Harbor Safety Plan Chapter II: General Weather, Currents and Tides for discussion.

### **Tugs with Tows <1600 Gross Tons Not in Petroleum Service: Guidelines for Navigating in Severe Weather**

A number of factors must be considered when limiting transits in the Bay or closing the Bar due to severe weather, including sea state, tidal influences, visibility, traffic density, and wind advisories issued by NOAA. The size and condition of the vessels being addressed must also be considered. The Tug Escort Work Group recommends a tiered approach, applying greater caution as conditions worsen.

#### ***Sustained winds exceeding 25 knots in the Bay***

- Tugs with tows should closely evaluate whether it is safe to transit in the Bay. Size and sail area of the vessel, tidal influences, visibility, operator skill and traffic density should all be considered.
- VTS San Francisco will establish regular communications with bridge watches of VTS users in Bay Area anchorages, and more closely monitor swing circles to ensure vessels are not dragging.

#### ***Sustained winds exceeding 40 knots in the Bay***

- Transits to and from berths are not recommended, but may be performed following a careful risk management evaluation by the vessel operator and vessel management.

#### ***Sustained winds exceeding 40 knots and/or seas exceed 12 ft at the Sea Buoy***

- Bar traffic restrictions and closure should be considered for tugs with tows. Size of the vessel, draft, swell period, tidal influences, visibility, and traffic density should all be considered. Strong ebb tides should be avoided, and a minimum of 10 feet underkeel clearance is recommended.

Adopted February 2009. See Harbor Safety Plan Chapter II: General Weather, Currents and Tides for discussion.

## **Appendix A**

### **Emergency Training for Tug Escorting**

A set of recommendations for conducting Escort Training on San Francisco Bay is included in the Harbor Safety Plan (Appendix J). The guidelines anticipated live escort training exercises; however, few opportunities arise for on-water exercises involving tankers and tugs, with few individuals trained for emergency events. With maritime simulators becoming more sophisticated in their ability to replicate a variety of situations and with a California Maritime Academy simulator operational, the HSC found simulating local conditions to be a cost-effective alternative to on-water exercises.

The Work Group concluded that in addition to promoting simulator training for tugs escorting tankers, simulator training is applicable to tugs assisting and docking container ships, bulk carriers and chemical ships – thus providing industry-wide benefits for safe navigation.

The HSC recommends the use of simulators to improve communication between pilots and tug masters, offer in-house training to tug industry personnel, and provide valuable “lessons learned” for emergency situations in a controlled environment.

Adopted November 2008. See Harbor Safety Plan Chapter XIV: Tug Escort/Assist for Tank Vessels for discussion.

### **Small Passenger Vessels - Ferries: Recommended Guidelines for Navigating in Reduced Visibility and Severe Weather**

#### **Safety Practices**

The Master of a ferry is the person in charge of the vessel, responsible for the safety of the passengers and crew at all times, and has the authority to decide if it is safe to get underway or to proceed.

In reduced visibility and inclement weather conditions, the following practices are followed:

- A go or no-go decision to get underway is made by the vessel Master or the company Operation Manager, based on conditions along the entire route, using all available information including the experience of the master and operations manager.
- Look-outs: the vessel Master assigns crewmembers for look-out duty based on the existing or anticipated conditions; the applicable regulations are found in the Navigation Rules and Regulations, Rule 5 Look-out (text attached).

## Appendix A

- Safe speed: the vessel is required to proceed at a speed appropriate to the prevailing circumstances and conditions, which include state of visibility and the manageability of the vessel with special reference to stopping distance and turning ability. Other factors include participation in fixed ferry routes, wind advisories issued by NOAA, sea state, traffic density, and applicable Navigation Rules and Regulations (see attached verbiage from Rule 6 Safe Speed).
- Equipment: each Ferry is required to have at minimum one radar; commuter ferry vessels generally have two operational radars onboard; the vessel Master is required to have a radar observer license endorsement. Global Positioning Satellite, Automatic Identification System and Electronic Charting navigation systems are also installed and used to assist navigation.

### In conditions of high wind and waves:

- Go/no-go decision is made by the vessel Master or the company Operation Manager, based on conditions along the entire route, using all available information including the experience of the master and operations manager. Factors to be considered include size of the vessel, direction of the winds and seas, orientation of departure and arrival piers to prevailing conditions, and limitations of ferries to travel at slower speeds.
- Passenger safety: Captain can maneuver the vessel to minimize wave effects. Crew duties include rough weather announcements and passenger safety management.

### **High Speed Ferry Operations (over 30 Knots)**

U.S. Coast Guard Navigation and Vessel Inspection Circulars (NAVIC) 5-01 and 5-01 Change 1 provide specific guidance for high speed passenger vessels and include approved vessel operation manuals, training programs and risk assessment tools (matrix).

- Vessel equipment: operators have exceeded minimum requirements for navigation electronics including dual radar, Global Position Satellite and electronic charting with Automatic Identification System overlay.
- Manning/Training: Vessels traveling at high speed are required to have a minimum of two qualified watch-standers during normal operations. Vessel operators have developed approved training programs for high speed navigation in compliance with NAVIC 5-01 and 5-01 Change 1.

Adopted February 2009. See Harbor Safety Plan Chapter XI: Small Passenger Vessels - Ferries for discussion.

## **Appendix A**

### **Passenger Ferry Traffic Routing Protocol**

To avoid future possible ferry collisions, particularly in light of expanded fast ferry service, a protocol for ferry navigation in the San Francisco and San Pablo Bays includes routes and a Ferry Building Approach Zone, as shown in Figures 1-7 below.

Adopted May 2008. See Harbor Safety Plan Chapter XI: Small Passenger Vessels - Ferries for discussion.

# Diagram Key

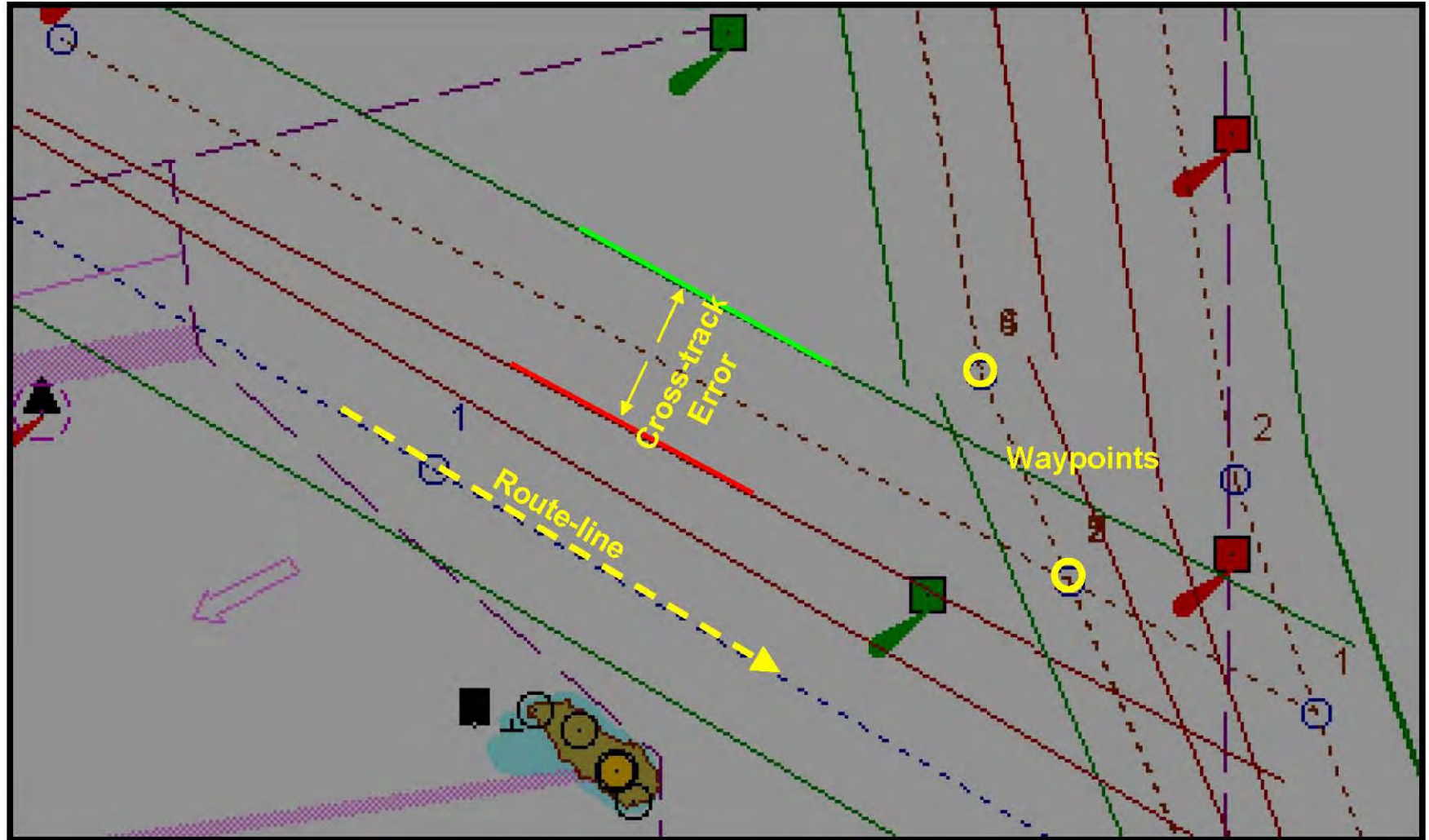

The following chart features are highlighted above.

- Route-line: Centerline of the ferry route.
- Cross-track Error: Left and right of route-line tolerance.
- Waypoints: Turns, route crossing points, and communications points.



# Central Bay and South San Francisco Bay

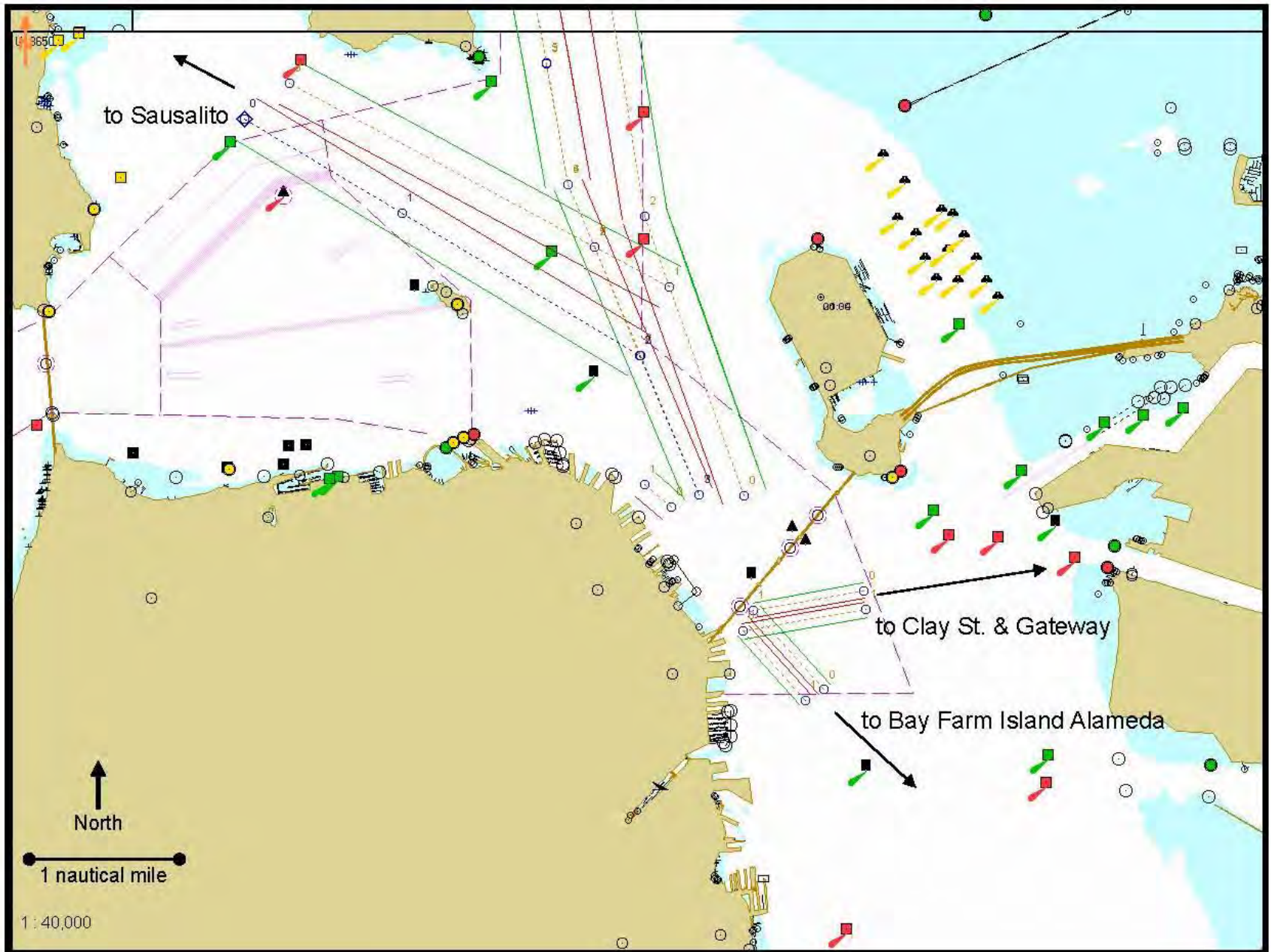



# North Channel and Southampton Shoal Channel

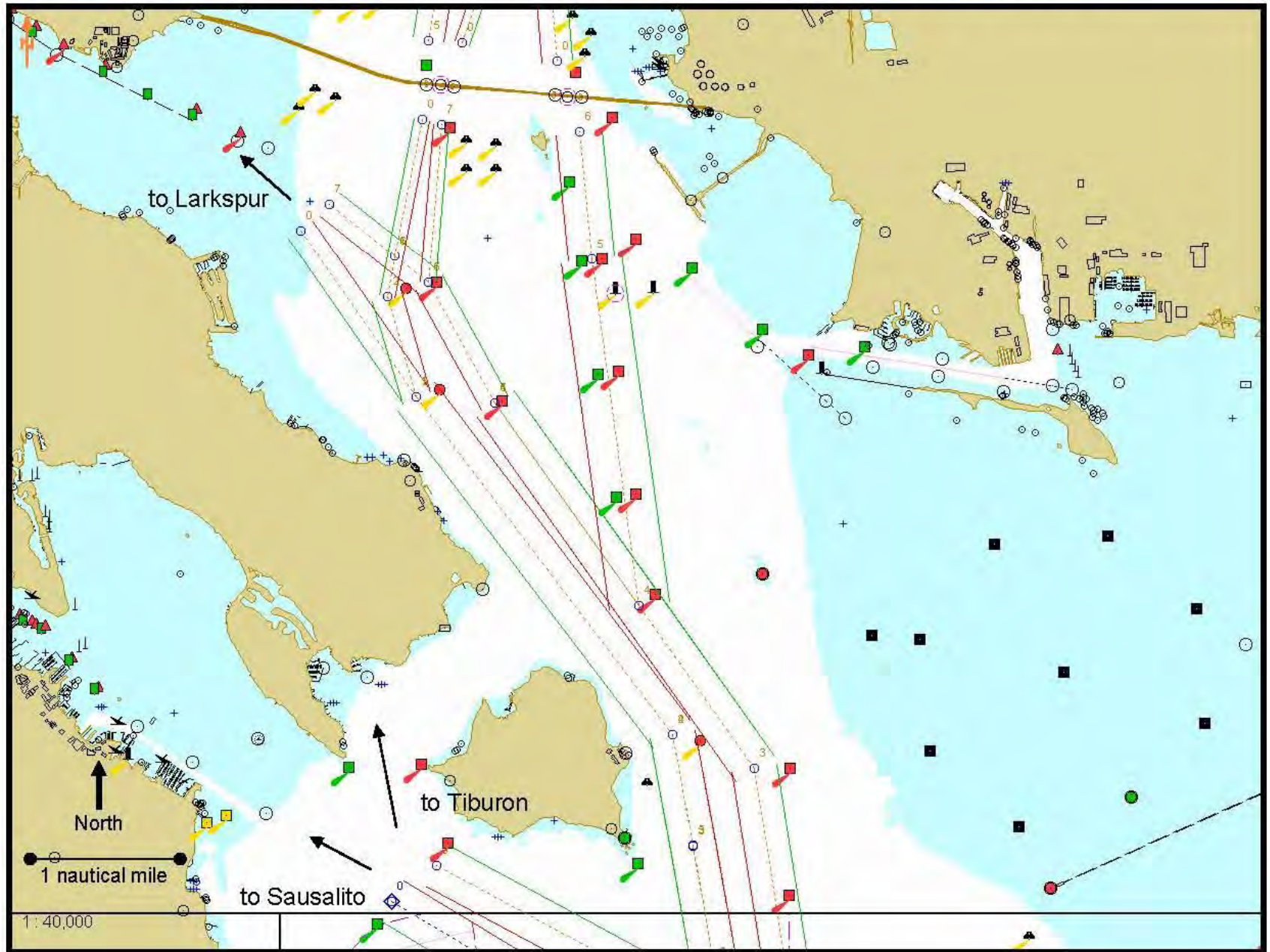

# San Pablo Strait Channel

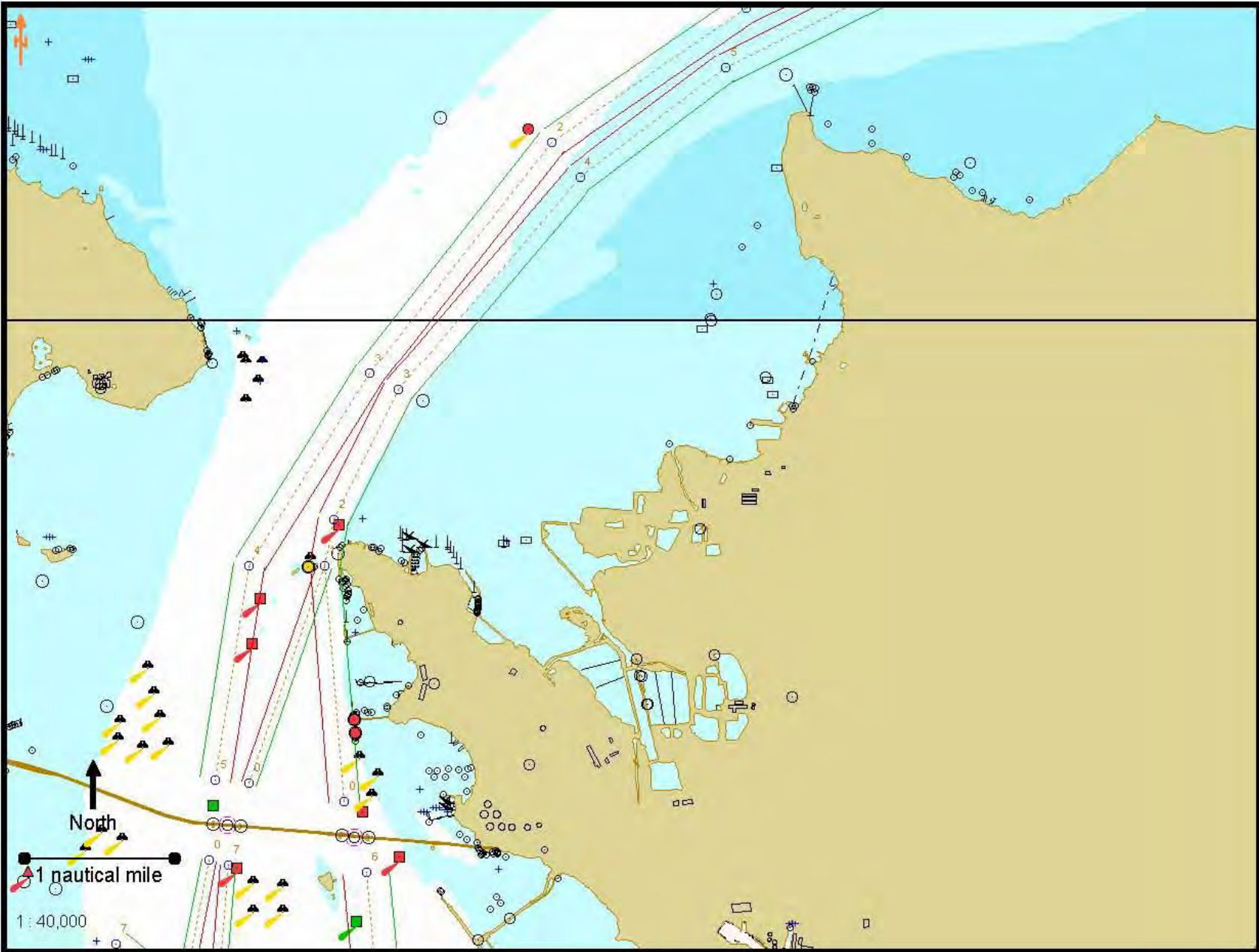



# San Pablo Bay and Mare Island Strait

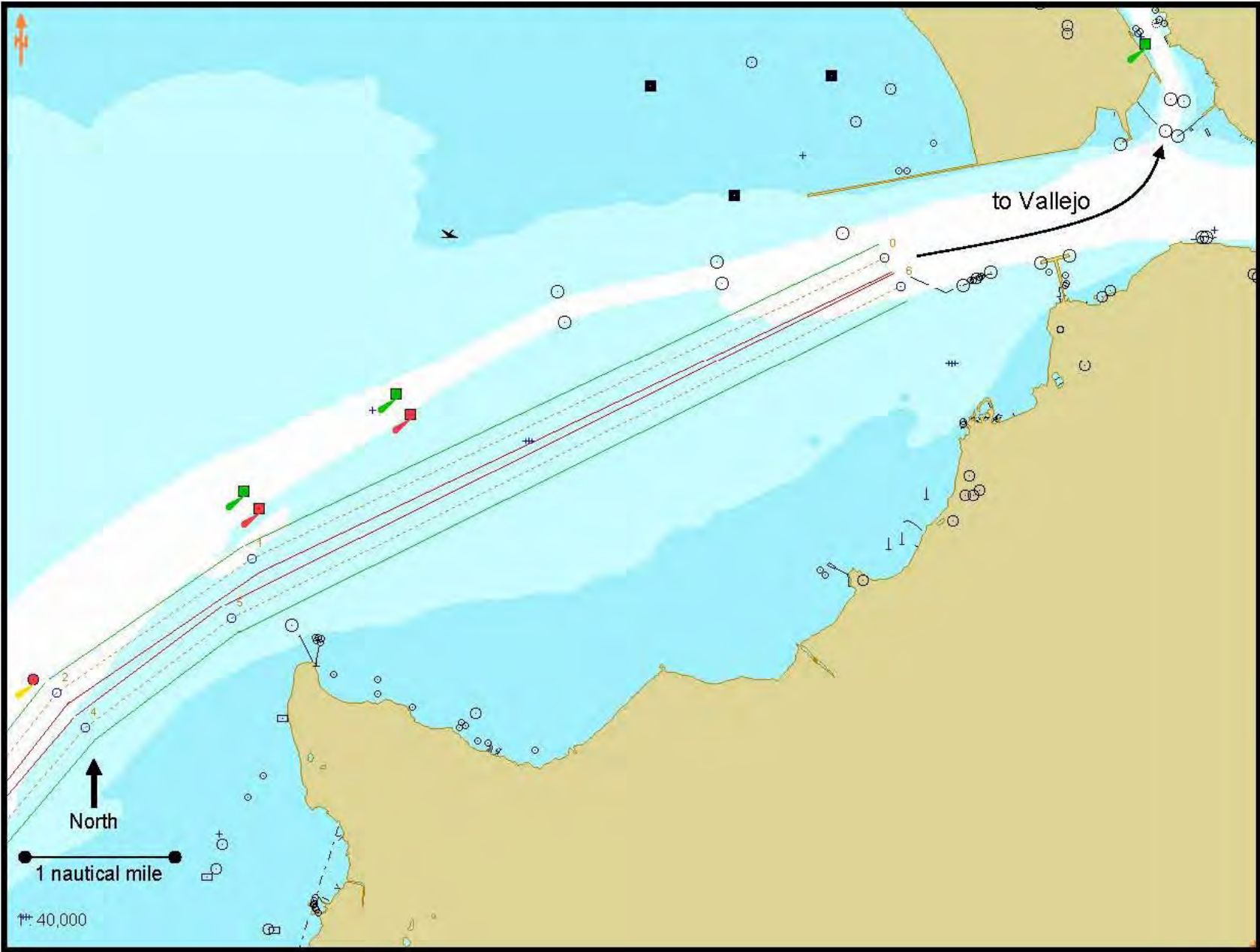

# Ferry Building Approach/Departure Zone

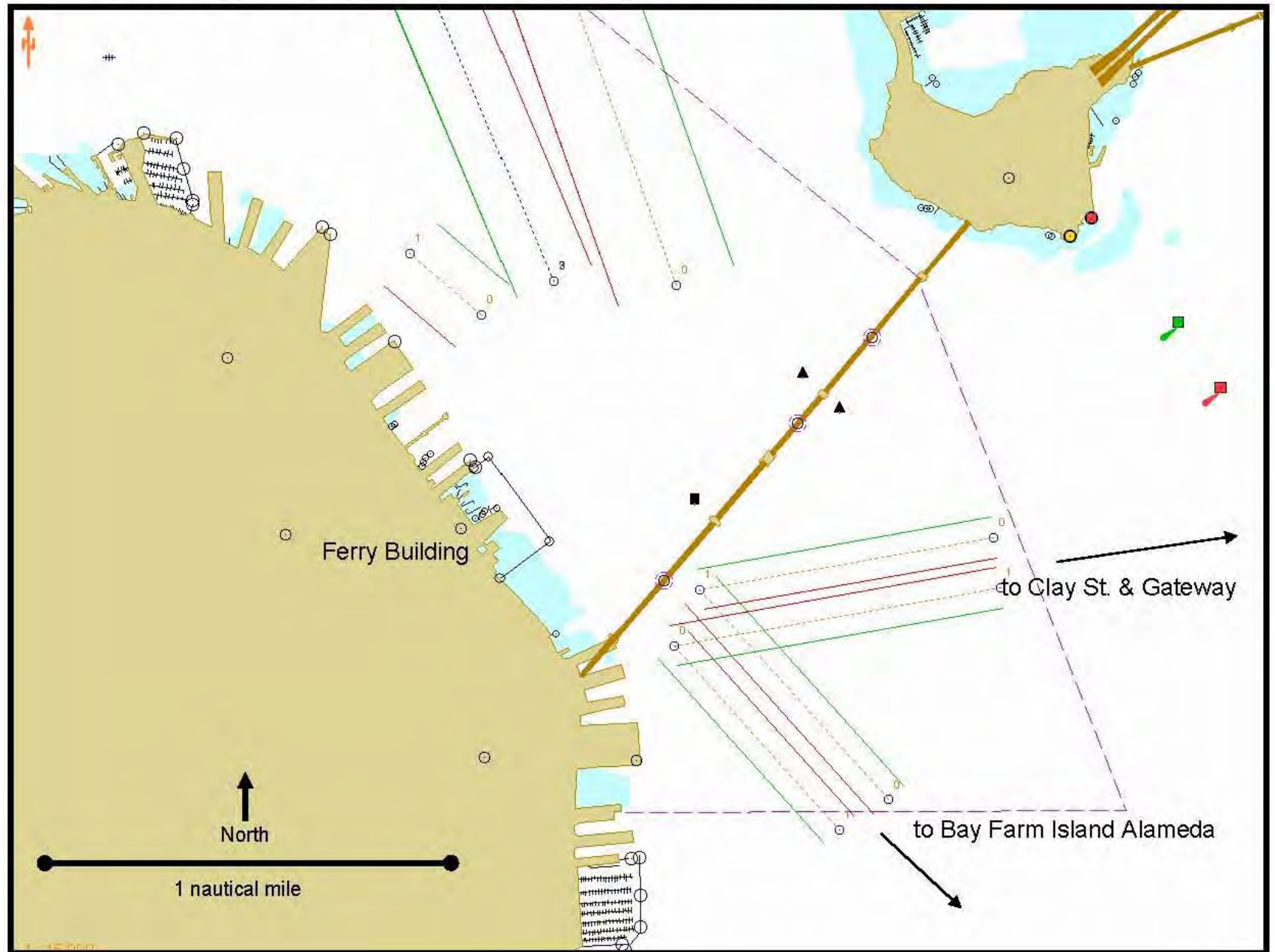



# Ferry Building Maneuvering Area

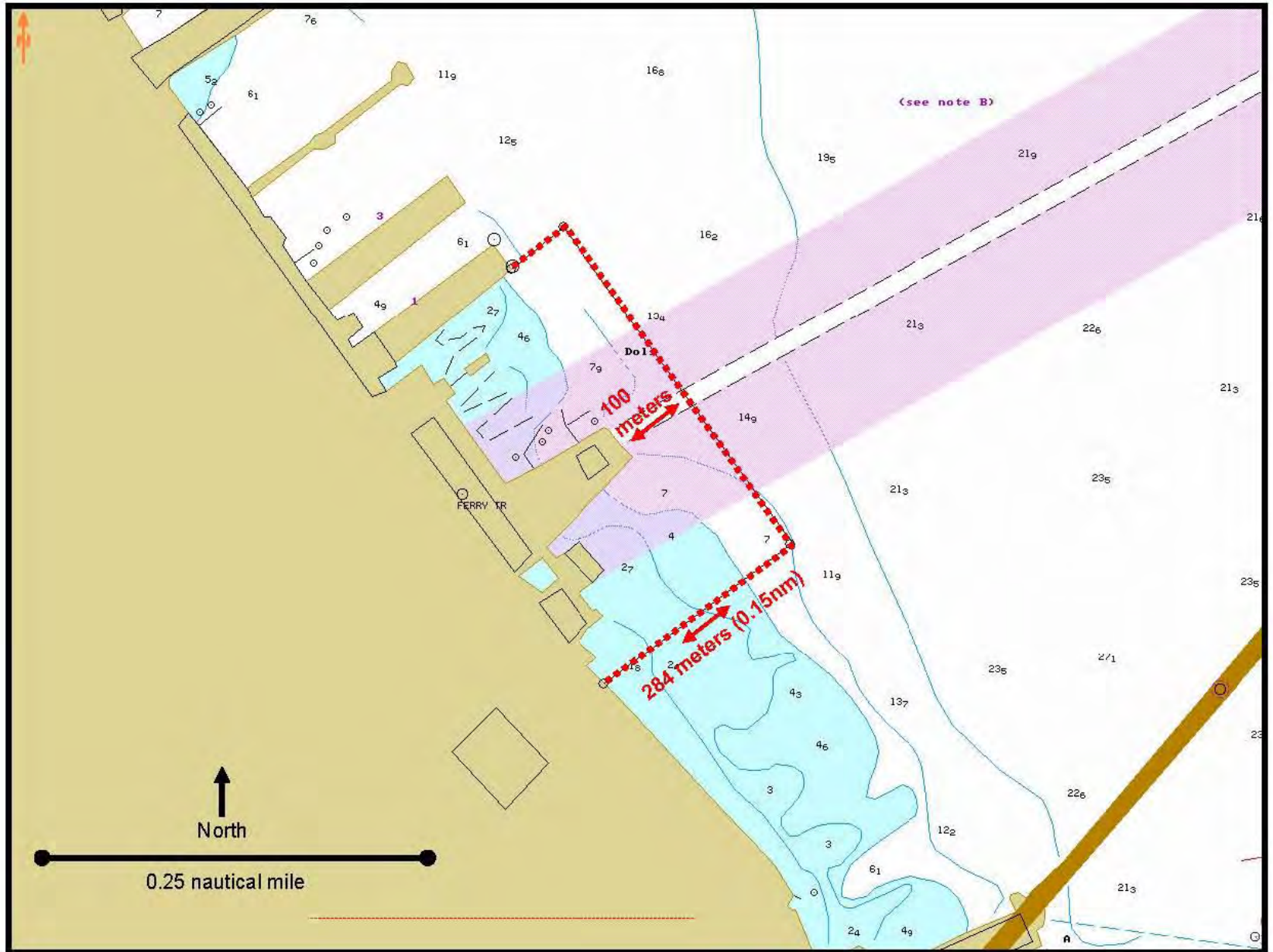

# Source and Contact Information

Diagrams are screen print files from vector-based electronic nautical charts (ENCs).

Additional lines and labels were added to the screen print files for emphasis and clarity.

For more information contact:

**Scott Humphrey**

Training Director

Sector San Francisco Vessel Traffic Service

Phone: +1 415 399 7444

Email: [scott.humphrey@uscg.mil](mailto:scott.humphrey@uscg.mil)

## **Appendix A**

### **Communication Procedures to Improve Safety During Bunker Barge Transfer Operations Alongside Container Vessels**

**Container Vessel Bunker Barge Safety Program and Delivery Notice.** This document outlines the process for essential communication between the agents, bunker barge operators (tankermen) and terminal's Marine Department to ensure a safe and productive work environment. The Container Operator has adopted this Best Management Practices Program and has instituted it to assist all parties involved in the vessel operations when vessel bunkering is involved in the operation.

The "Bunker Delivery Notice" appears at the end of this section. The Agent will e-mail the notice to the Ship, Terminal and the Bunker Barge operator prior to the stevedoring operation. The terminal, ship and barge operator will reply to the E-mail by including the contact phone/cell number of the person working that vessel/shift. This will be the cross check that all parties are aware of during a planned bunkering operation.

#### **Essential Communications: Contact between the Tankerman and Terminal**

- The Bunker Barge Operator (Tankerman/Person in Charge (PIC)) must contact the Designated Facility Contact prior to beginning the barge operation. This will allow the Tankerman/PIC to learn the planned stevedore operation in the CFS/CLO and highlight any possible conflicts. (A Check Sheet shall be used for this function.)
- The Bunker Barge representative (Tankerman/PIC), must communicate with the Designated Facility Contact, and Chief Engineer/Chief Mate, (vessel PIC) prior to beginning the barge operation. This will allow the Tankerman to learn the planned stevedore operation and highlight any possible conflicts so they may be eliminated.

#### **Essential Communications: Tankerman Check Sheet**

- a. What are the bay designations directly forward and aft of the house on this vessel that overlap the bunker barge?
- b. Is there any planned loading, discharging, or lashing in these bays?
- c. When does the terminal plan to work these bays?
- d. Is any of the work in these bays going to extend into the two or three offshore positions?
- e. Can these positions be worked in a specific time frame so possible conflicts are avoided?
- f. What time periods is the stevedore going to shut down cargo operations for breaks, lunch, etc.?

## **Appendix A**

### **Understanding the Bunkering Process #1**

- Vessels contract for Bunkers
  - Oil Companies notify barge operators
  - Agents coordinate delivery notifications with barge operators and terminals
  - Bunker Barge arrival time and duration of pumping is established

### **Understanding the Bunkering Process #2**

- Vessel Arrives for Cargo Operations
- Agent Coordinates bunker barge arrival
- Terminal plans operations
- Cargo Flow Sheet or Crane letter of Operations (CFS or CLO) is prepared
  - Outlines what cargo is to be moved in what sequence
  - Terminal will plan around bunker operations if possible
- Terminal gives CFS/CLO to Agent to pass to Chief Engineer/PIC and Tankerman/PIC

### **Understanding the Bunkering Process #3**

- Bunker Barge Arrives for Bunker Ops
  - Optimal placement to minimize exposure.
  - Vessel insures BUNKER OPERATION SIGN is posted.
  - DOI is signed by Chief Engineer/PIC and Tankerman/PIC.
  - Tankerman/PIC /Chief Mate/Chief Engineer/PIC will have a copy of Cargo Flow Sheet or Crane letter (CFS/CLO).
- Tankerman/PIC should understand what cargo adjacent to the barge is to be handled and when.
- Tankerman/PIC shall have contact with the vessel Superintendent at all times.

### **Understanding the Bunkering Process #4**

- Vessel cargo operations commence.
  - Lashers sent aboard to unlash containers.
  - Crane lowered over hold/hatch to be worked.
- Work commences in accordance with CFS/CLO
  - Lashers sent aboard to re-lash containers
- Bunker operations could start before, during or after cargo operations
  - Tankerman/PIC, Chief Mate & Superintendent must understand where the stevedore operator is relative to the Cargo Flow Sheet or Crane letter and the bunkering process.



## **Appendix A**

### **Area or Zone of Concern**

- Tankerman/PIC, Terminal Personnel, (Superintendents, Foremen, Lashers, Crane Operators) and Vessel Personnel (Chief Mate and Engineer/PIC) all must be mindful of and take particular care when lashing or cargo operations take place in the outer three stacks of containers in bays adjacent to the bunker barge if the transfer is in progress.

### **Essential Communications: Bunker Delivery Notice**

- To inform all concerned parties of the planned bunkering operations, the Vessel Agent (or other carrier assigned representative), will complete a “Bunker Delivery Notice”.
- The Agent will forward the notice by E-mail to BOTH the terminal and the bunker barge operator prior to the start of any stevedoring operation.

### **Post Incident Response**

- It is expected that the Tankerman will be alert to the crane working near the barge and the cargo flow that has been planned.
- It is expected that the Tankerman/PIC will determine the proper action to take regarding oil transfer process should any incident occur which affects the safety of the operation.
- Any incident will require direct communications between the parties involved who shall be readily available. This will allow for adjustments to working plans to correct conflicts.

### **Long Term Incident Resolution**

- It is expected that the Operations Department’s management personnel, vessel representative, and the barge operator will discuss mutually agreeable adjustments to minimize Tankerman exposures that may be determined as the result of the incident and the post incident investigation.
- Ideas and lessons learned will be shared among all parties including the other Port Terminals.

Adopted February 2009.

**Appendix A**

**Bunker Delivery Notice**

<b>Date:</b>	<b>Port:</b>	
<b>Vessel:</b>	<b>Voyage:</b>	
<b>Reference #:</b>		
<b>Bunker Barge Co.</b>		
<b>&amp; Phone:</b>		
<b>Name of Bunker Barge:</b>		
<b>Name of Bunker Barge PIC:</b>		
<b>Contact Phone # of Barge PIC:</b>		
<b>Bunker Barge Emergency Contact #:</b>		
<b>Amount and type to be bunkered:</b>		
<b>Delivery Time of Bunkers:</b>		
<b>Location of Delivery of Bunkers:</b>		
<b>Bunker Barge to Land Side to as Vessel (select Port or Starboard):</b>	<b>Port</b>	<b>or Starboard</b>
<b>Estimated duration of bunker delivery:</b>		
<b>Designated Facility Contact:</b>		
<b>Terminal Emergency Phone #:</b>		
<b>Name of Vessel PIC for bunkers:</b>		
<b>Telephone number of vessel:</b>		
<b>Location of Bunker Manifold/Riser:</b>		
<b>Agent for Vessel:</b>		
<b>Agent Cell Phone #:</b>		
<b>Agent 24 Hour Contact #:</b>		

## **Appendix A**

### **SAFE BUNKERING OPERATIONS ALONGSIDE OAKLAND BERTHS 35, 37 and 55-59**

The following best practices are in addition to “Recommended Best Practices for Safe Bunkering Operations Alongside Cargo Vessels”.

1. Prior to arrival of the bunker barge alongside the receiving vessel, the tug captain or mate will contact the Marine-Exchange for arrival and departure information for all vessels transiting OOH (Oakland Outer Harbor) or OIH (Oakland Inner Harbor) over the intended duration of the transfer.
2. Following arrival, the tug captain or mate will notify Vessel Traffic to request all vessels to proceed slowly and with caution when passing the bunker barge. (Not to be confused with a minimum wake).
3. The tug will monitor VHF channels 13 and 14 and the channel agreed to in paragraph 6 at all times during the transfer.
4. Tug will remain made fast to the barge at all times during the bunker transfer. The tug will be standing-by with engines running and with a licensed officer in the (operating) wheelhouse when vessels are transiting the immediate area.
5. A minimum of 2 headlines, 2 spring lines and 2 stern lines will be used to secure the tug/barge unit to the vessel. One bow and one stern line will be from the offshore cleat, bitt or chock of the barge.
6. In order to provide direct communications with the barge and tug, the barge or tug will provide the receiving vessel with a walkie talkie for the ship’s watch stander who will be stationed at the manifold area to tend the hose and lines.
7. Tug Captain or Mate will obtain from the Pilot Dispatcher the name and unit number of each pilot on vessels transiting the area for possible direct communications. (Pilot list is a useful tool for gathering transit information).
8. Bunker transfer operations will cease when vessels are transiting the immediate area in OOH and OIH.
9. A second man will be stationed on the barge when vessels are transiting the immediate area in OOH and OIH.
10. The pilot of the vessel transiting the area of concern will contact the tug standing by the barge on VHF channel 13 to confirm that the measures noted above have all been met and that the tug is standing by.

# Appendix A

## BUNKERING -- BEST MARITIME PRACTICES FOR THE STATE OF CALIFORNIA

### A. GENERAL INFORMATION

1. The marine waters of California are environmentally sensitive and a precious environmental and economic resource. Bunkering operations, while routine in many parts of the country, do in fact pose risks different than those normally expected of standard shore to ship oil transfer operations. The California Department of Fish and Wildlife (DFW), Office of Spill Prevention and Response (OSPR), and representatives of the shipping and petroleum industry have jointly developed the following guidelines to address those risks and ensure safe bunkering operations in the State of California. They recognize that the *safe* transfer of fuel oil into a vessel requires diligence, safety consciousness and the use of proper procedures. Safe bunkering is the product of good communication, proper crew training and compliance with international, federal, state and local laws including but not limited to;

"Any owner, operator, or person-in-charge of an onshore or offshore facility or vessel over which the U.S. has jurisdiction (i.e., a U.S. vessel or a facility or foreign vessel in U.S. waters) from which oil or an EPA designated hazardous substance is discharged in "such quantities as may be harmful" into navigable waters of the U.S., upon the adjoining shorelines, into contiguous zone waters, in connection with activities under the OSCLA or the DPA, or that may affect natural resources under exclusive U.S. management authority, is subject to a civil penalty assessment separate from any other civil or criminal penalty or liability imposed by the Federal Water Pollution Control Act (FWPCA) (except in the case of certain EPA permit related discharges). This act prescribes that a civil penalty of not more than \$5,000 for each offense shall be assessed. The FWPCA also requires that the person-in-charge of the vessel or facility must, as soon as acquiring knowledge of any discharge of "such quantities as maybe harmful" of oil or reportable quantity of hazardous substance, immediately notify the appropriate agency (the Coast Guard). The NRC has been identified as the primary location for receiving reports of oil discharges or hazardous substances releases. When the NRC cannot be contacted, 33 CFR 153.203 lists other agencies that may be notified. Failure to give immediate notice makes the responsible person subject to criminal penalties of not more than \$10,000 or a year's imprisonment, or both. Masters, licensed officers and operators, and other persons certificated by the Coast Guard may also be subject to suspension and revocation (S&R) proceedings conducted under the authority of 46 U.S.C. Chapter 77 and 46 CFR 5. Discharges may also result in other civil penalty and criminal fine provisions under Section 309 of the FWPCA, the Rivers and Harbors Act 99 (the Refuse Act), and the APPS 1980."

(Marine Safety Manual COMDTINST M16000.6, 1.E.7 p. 1-24-25)

## Appendix A

2. Bunkering Operations within California waters are subject to U.S. Coast Guard regulations, Title 33 Code Federal Regulations, Parts 155 and 156, and California Code of Regulations (CCR) \*, Title 14, Chapter 3, Subchapter 6. These regulations are listed in paragraph 7 below. Beyond the regulations, the guidelines below represent the cooperative efforts of OSPR and stakeholders to develop the best way to further mitigate risks to the environment during bunkering operations. As such, it is expected that industry members follow them, educate and enforce them among industry groups and make recommendations to OSPR, and the appropriate local Harbor Safety Committees as changes are needed. Vessels intending to conduct bunkering operations while at anchor should also carefully review the guidance in the following additional best maritime practice.
3. Some bunkering operations are conducted alongside vessels at berth and, in the case of container vessels, may be conducted simultaneously with container operations. This adds some additional risk to bunkering operations and the personnel involved for which additional precautions are necessary. The procedures associated with these bunkering operations are covered in the Harbor Safety Plans.
4. The OSPR and the U.S. Coast Guard inspectors frequently monitors fuel/oil transfer operations throughout all of California's harbors and bays based on the level of risk, amount of fuel/oil, familiarity with company operations, procedures and track records. Either agency may stop any bunkering operation or prohibit planned operations due to safety concerns or unacceptable risk.
5. The OSPR will periodically review the safety record of bunkering operations and work with the Harbor Safety Committees to determine if changes are needed to promote safety. Changes could include additional best maritime practices or a formal regulatory initiative.
6. **Definitions:** In addition to the terms defined in applicable federal regulations, the following definitions apply:
  - a. Bunkering: The transfer of petroleum base products from one vessel to another vessel for the purpose of replenishing fuel for vessel propulsion, hotel services or machinery lubrication while at anchor or dockside.
  - b. Receiving Vessel: The vessel receiving the fuel or lubes in a bunkering operation.
  - c. Delivering vessel: The vessel delivering the fuel or lubes in a bunkering operation.
  - d. Moderate Weather: Sustained winds from 21 to 33 knots or higher gusts (Small Craft Advisory).
  - e. Heavy Weather: Sustained winds from 34 to 47 knots or higher gusts (Gale Warnings).

## Appendix A

7. **Regulations:** Bunkering operations must be conducted in strict accordance with the letter and intent of all regulations. If there is a conflict, real or perceived, between the regulations and the guidelines in this document, then the regulations shall take precedence. However, any such conflict should be reported to the applicable Harbor Safety Committee. In the state of California Bunkering operations fall under following regulations:
- a. 33 CFR 152 Notice of Discharge and Removal of Discharged Oil\*
  - b. 33 CFR 155 Oil or Hazardous Material Pollution Prevention Regulations for Vessels\*
  - c. 33 CFR 156 Oil and Hazardous Material Transfer Operations\*
  - d. 46 CFR 30-40 Tank Vessels\*
  - e. CCR Title 14 , Chapter 3, Subchapter 6 Oil Transfer and Vessel Operations\*

Additionally, bunkering activities may also be subject to local regulations and terminal requirements and or guidelines. As laws and regulations may change from time to time, a vessel operator should check with their agent and/or local authorities for the most current regulations and requirements.

### **B. Best Maritime Practices – BUNKERING**

Maritime safety is a people process. Virtually every marine accident or oil spill is the result of human error. The below Best Maritime Practices have been developed to further mitigate the risk of spills to deck and or water. It is well-trained people working conscientiously together that make safe seamanship a reality.

#### **1. Prior to Arrival of the Receiving Vessel**

##### **a. Pre-Arrival Information (Receiving Vessel)**

Prior to bunkering, the following information will be provided to the delivering barge company by the receiving vessel:

- Estimated time of arrival.
- Location in port where bunkering will take place.
- Name and Contact information for the vessel's QI (Qualified Individual).
- Copy of California Vessel Oil Spill Contingency Plan Approval Letter.
- Confirmation of Federal and State Certificates of Financial Responsibility ('COFR').
- Verification of the OSPR required spill kit onboard the ship.
- Location of bunker station
  - distance forward from the vessel's stern.
  - distance of bunker connection from water line to rail.

## Appendix A

- distance of bunker connection from rail.
- bunker manifold flange size and bolt configuration.
- Side of vessel, port or starboard.
- Complete the Pre-Arrival Check List.
- Acknowledgement that Hot Work and other restricted activity will not be conducted until the delivering vessel has departed.

### b. Notifications \*

The ship should make notifications to their OSRO and their twenty-four hour shoreside QI in the event they are contracted through 3rd party services.

### c. Identify Person-In-Charge\*

The first step in safe bunkering is to identify the vessel's Person-In-Charge ('PIC'), who is responsible for the bunkering operation. They must be a licensed or authorized master, mate or engineer.

### d. Identify the Oil Transfer Procedures

The PIC must identify and be familiar with the vessel's oil transfer procedures.

***Oil Transfer Procedures shall be prominently posted for easy reference!***

#### ▪ **Transfer Procedures shall include;**

- The location of pipelines, valves, vents and overflows,
- The numbers and duties of people assigned to the transfer operation,
- All relevant procedures before, during and following oil transfer,
- Detail critical steps for communication,
- Steps for topping off tanks, and
- Steps for initiating an emergency shutdown.
- Weather and sea state limits that require transfer shutdown.

### e. Designate Key Transfer Personnel \*

The Person-In-Charge is responsible for ensuring an adequate number of personnel are ready and available to safely execute the transfer process. While the number may vary with the ship, weather, and port there shall be no less than 3 individuals on the receiving vessel assigned to the operation, and these individuals shall have no other assigned duties during the transfer process.

### f. Develop a Pre-Loading Plan (Receiving Vessel) Pre-Loading Plan Includes;

- **Tanks and Capacities**

## Appendix A

- **Oil Level and Type**
- **Expected Final Tank Gauges and Percentage of Tank Capacity**
- **Tank Loading Sequence**
  
- **Monitoring Procedures**  
*monitoring includes the fuel oil transfer as well as tank levels and valve alignments.*
- **Post a Completed Load Plan**
- **Max pressure at ships manifold**
- **Max rate of transfer**
  
- Personnel shall include:
  - Person-In-Charge (PIC) – Responsible for the transfer operation.\*
  - Point-of-Transfer Watch – This person remains at the connecting point between the transferring and receiving vessels throughout the transfer process.
  - Deck Rover Watch – Responsible for monitoring the deck and over the sides for spills; should be aware of all the source locations for a potential release of oil.
  - Additional Personnel – Good seamanship dictates that there will be circumstances that require the receiving vessel to assign additional personnel. They may include but are not limited to the following.
    - Monitoring of multiple tank levels at different locations.
    - Topping of tanks.
    - Need for an anchor watch.
    - Rain or other environmental circumstances that affect the operation.
  
- The PIC will ensure that all personnel on their vessel assigned to the transfer operation are well rested and within their work hour limitations. Even a crewmember within their work hour limitations can be fatigued due to a number of circumstances. A fatigued crewmember should be relieved by a rested crewmember.

### **g. Pre-Arrival Training**

A good bunkering operation begins with proper preparation. Everybody who is involved in the training session should be told everything about the bunker operation. Not more than 48 hours prior to arrival, all members of the crew



## Appendix A

that may be called upon to participate in the loading operation shall attend a training session. Training shall include:

- Review Bunkering -- Best Maritime Practices (BMP)
- Review Vessel Specific Transfer Procedures
- Review Crew Roles and Responsibilities
- Review Pre-Loading Plans
- Communication Procedures
- Stop the Transfer Responsibility

*Ensure everyone involved in the bunkering operation knows he or she has the responsibility to stop the transfer process at any time, should anything appear to be out of order.*

*If watches will change during the bunkering operation, include relief personnel in training session and the pre-loading plan.*

A log entry shall be made of the crewmembers, their rating and the time of the training session.

### 2. Bunkering Operations \*

#### a. Prepare Deck and Receiving Areas

To include, but may not be limited to the following:

- Close and secure all required hatches, doors and portholes.
- Seal all scuppers and drains from which overflowing oil might spill over the side of the vessel.
- Ensure a well-lit receiving area to provide for efficiency, safety and crew alertness.
- Post all proper warning signs and signals.
- Make a visual inspection of all the applicable equipment on both the receiving and delivering vessels.

#### b. Mooring Equipment \*

The delivering vessel shall be responsible for the safe mooring of their vessel alongside the receiving vessel. They shall use fenders of sufficient size and type to prevent steel to steel contact between the two vessels. Mooring lines will be of sufficient size and type to hold the delivering vessel alongside the receiving vessel during the maximum expected tidal, wave, and wind conditions.

#### c. Provide Safe Access Between Vessels

The receiving vessel must provide safe access to and from the barge utilizing a gangway or an appropriate accommodation ladder, in order to facilitate face to face communications between the receiving and the delivering vessels for purposes for a

## Appendix A

pre-transfer conference and other required communications.

Where safe access cannot be provided an alternate method of facilitating a face to face conference must meet the following guidelines and a notification will be made to OSPR and USCG by the delivering vessel;

- Both the receiving vessel and delivering vessel's PICs will still execute a conference in sight of each other with a clear method of communication in order to cover all items outlined in the pre-transfer document as well as the Declaration of Inspection.\*
- Direct communications between PIC's will be made in order to alert the delivering vessel when the receiving vessel is topping off, or switching between tanks.\*
- Reiterate the need for a 10 minute standby notice before any tank switches.
- Direct communications between both PICs no less than every 20 minutes.

### **d. Establish Communications \***

The receiving vessel and delivering vessel shall agree on the communications to be used during the process. These include:

- Coordinating radio frequencies,
- Common English phrases,
- Proper hand signals, and
- Use of air horns.

***Ensure everyone involved knows he or she has the responsibility to stop the transfer process at any time, should anything appear to be out of order***

### **e. Conduct a Pre-Transfer Conference**

Each pre-transfer conference is unique. Different people, different languages, different fuel requirements, different conditions all play a role in determining the content and structure of the conference. Out of these differences, a common understanding must be established and a common process used. The pre-transfer conference must include the following:

- Be conducted in English.  
A vessel agent can arrange for a translator or interpreter. If one is necessary they must remain for the duration of the transfer operation.
- Be conducted face to face. (Except as allowed for in Section c.)
- Thoroughly review the Declaration of Inspection (DOI) and Load Plans, with both PICs discussing and initialing each item including:
  - Products, Sequence and Flow rate of Oil\*

## Appendix A

- Key Procedures\*
- Identify Key Personnel\*
- Watch Changes\*
- MSDS information for the product(s) to be transferred\*
- Notification of Shutdown or topping off procedures.\*

### f. **Connect Oil Transfer Hose\***

Be sure to handle the hose carefully. It may still contain oil from a previous transfer. The receiving vessel shall:

- Check the hose for obvious defects.
- Check the hose support and lead. The weight of the hose should not put undue strain on the manifold, rail or other fittings.
- Use a new unused gasket.
- Tighten all bolts, evenly, with a matching bolt in every hole.
- Double check alignment of all valves.
- Ensure containments are kept free and clear of debris and rain water.

### g. **Complete and Sign the Declaration of Inspection (DOI)\***

Both vessels must keep a copy of the DOI for 30 days, along with a copy of the vessels load plan.

### h. **Begin Fuel Delivery**

- Fuel flow should commence at a slow rate.
- *All tanks should be sounded to ensure fuel is loading into the designated tanks and not into the wrong tanks.*
- The pressure should be monitored on the delivering and the receiving vessel's manifold. A high pressure reading could signal a blockage or improper alignment.
- Receiving vessel must alert barge crew at least 10 minutes before changing tanks, topping off tanks, or securing the loading operation.
- The delivering vessel and receiving vessel should compare the amount of fuel transferred between each vessel and at regular intervals. If upon comparison in the amount of fuel transferred, a discrepancy of concern is identified, the transfer should be secured until the discrepancy is rectified.
- Bunker transfer rate should be compared at regular intervals. This practice will help to avoid tank overfills and enable a PIC to

## Appendix A

estimate the time for topping off tank(s) or stripping of tank(s), tank switching and time of completion.

- Maintain constant communication. A regular schedule of communications should be established. Not to exceed 20 minute intervals, a status report exchange between the receiving vessel and delivering vessel shall take place\*. This is in addition to the notifications above. **Failure to receive a response from any effort to communicate shall result in an immediate shutdown of operations.**
- Verify operation and accuracy of gauging systems.
- Test and verify bunker tanks alarm, settings and overfill alarm units.\*
- Bunker tanks which have been secured should be checked frequently during the remaining loading operations to avoid an overflow.

### i. Securing Bunker Operations and Disconnecting Transfer Hose

Upon securing of bunker operations;

- Check to make sure there is no flow at the manifold before closing the bunker manifold valve.
- The PIC's on both vessels should check fuel tank levels and verify all valves are securely closed.
- The receiving and delivering vessel's crews should verify that the hose is depressurized and drained back into the barge.
- The hose connection shall be blanked and bolted with a matching bolt in every hole. \* It should be cleaned of any surface oil before being passed back to the delivery vessel.
- Hot Work and other restricted activity should remain secured until the delivering vessel has departed.

### j. Number of Vessels Involved

A receiving vessel may receive bunkers and lubricating oils from two separate delivering vessels at the same time, provided:

- Each transfer has a separate Person in Charge ('PIC') unless otherwise approved by the Coast Guard Captain of the Port.
- That each system is completely separate from the other or is otherwise effectively isolated or segregated by means of blank (spectacle) flanges which may be visually verified.

## 3. Should a Spill Occur

### a. STOP THE PRODUCT FLOW

- **Notify the barge immediately to Shut Down and inform the barge of what happened and whether or not the flow has been stopped.**
- Delivery vessel to inform receiving vessel when transfer is stopped.

## Appendix A

- Bunker manifolds to be shut.
  - When shut down, advise delivery vessel if outflow has stopped.
  - Barge to commence deploying boom. (Even if release is not believed to have reached the water).
  - b. **WARN PERSONNEL**
    - Ensure the personnel on the ship, barge and shore are aware of the spill and are taking the necessary precautions to remain safe and secure the vessel.
  - c. **SHUT OFF IGNITION SOURCES**
    - Motors, electrical circuits, open flames, welding, etc.
  - d. **CONTAIN / CONTROL SPILL**
    - Ensure the barge is deploying their boom
    - Check ship's containment to ensure it is effective and sufficient
  - e. **MAKE APPROPRIATE NOTIFICATIONS AS PER VESSEL OIL SPILL CONTINGENCY PLAN\***
    - CCR, Title 14, Chapter 3, §817.03(g) and §827.02(d), Shall make notification within 30 minutes, after discovery of a discharge or threatened discharge of oil into marine water. Required notifications shall not be construed as requiring notification before response.
    - Communicate the incident to your company QI/OSRO\*
      - Injuries
      - Damage
      - Extent of release
      - Resources required
    - State of California's CalEMA\*
    - National Response Center\*
  - f. **Notify U.S. Coast Guard Vessel Traffic Service (VTS)**
4. **Port Specific Items**
- a. **Heavy Weather**
    - **Wind**: Vessels will not come alongside in preparation for bunkering at anchor or pier side if sustained winds are at or exceed 34 knots. If bunkering operations have already begun when sustained wind reach 28 knots personnel in charge of bunkering operations will continuously monitor environmental conditions and take any additional measures necessary to reduce risk of injury, vessel damage or pollution, and prepare for worsening weather. When sustained winds reach 34 knots bunkering operations will cease and hoses will be drained and disconnected.
    - **Seas**: For bunkering operations from one vessel to another vessel while at anchor, operations will cease, and hoses drained and disconnected when waves

## Appendix A

or swells reach 5 ft. The wind and sea conditions criteria have been developed with industry input and are used by operating companies in California. These standards are based on historical observations and experience in handling these vessels under the above prevailing conditions. Heightened safety and precaution should be taken during short interval wave periods.

- **Electrical Storm:** When an electrical storm is anticipated in the vicinity of a bunker transfer, shutdown and secure transfer operations. All tank openings and ventilation valves must be closed, including any bypass valve fitted on the tank venting system.\*
- **Sheltered Waterway:** The aforementioned wind and sea guidelines may not be applicable when a receiving vessel is being bunkered at a wharf or pier in a sheltered waterway. The criteria for securing a bunkering operation in these types of locations would be dependent upon adverse movement of either the receiving vessel or delivering vessel caused by the prevailing wind or sea conditions.
- **Tug Availability:** During bunkering operations with the potential to have adverse weather conditions involving vessels at anchor, at least one tug will remain ready to render assistance during the entire bunkering operation. The attending tug(s) must have sufficient horsepower to maneuver and control at least the delivering vessel involved in the bunkering operation under all conditions.

### 5. Ongoing Compliance and Continual Improvement

#### a. Drills and Exercises:\*

Equipment deployment drills shall be conducted twice a year by each bunker delivery company in each port. . These drills shall be conducted in an environment and under conditions similar to those that would be encountered during an actual oil transfers operation.

- The ability to deploy oil spill boom shall be drilled to demonstrate proficiency to the Administrator.
- At least one of these drills will be monitored by OSPR staff, and any documentation generated, including the list of the crew participating in the drill, will be submitted to OSPR. OSPR's Drills and Exercises Unit must be contacted in advance to schedule these monitored equipment deployment drills.
- If oil spill boom has been successfully deployed during a transfer operation, this may be counted toward the twice a year equipment deployment requirement. Any relevant documentation generated, including the list of the crew participating in the deployment, will be submitted to OSPR.

## Appendix A

- Vessel transfer units that utilize the services of an OSRO for standby booming, that have been rated to deploy the containment equipment, are not required to meet the twice yearly equipment deployment drills.
- In addition to these scheduled equipment deployment drills, the Administrator may also require the successful completion of an announced or unannounced equipment deployment drill.

The vessel owner/operator shall maintain adequate records of drills and exercises, for a period of at least three years, to include records of any off-vessel drills and exercises (i.e., drills and exercise not held aboard the vessel) of the spill response organization and resources identified in the contingency plan. These records shall be maintained at the United States location of either the Qualified Individual or the vessel owner/operator. Contingency plans should indicate the location of these records. All exercises conducted aboard the vessel shall be documented in the vessel's log.

When the owner/operator possess like boom deployment systems on their vessels, it is adequate to run a drill on one system, as a representative of the entire company.

b. **Inspections and Monitoring**.\*

The OSPR Administrator should carry out an inspection program which shall include the following:

- The Administrator shall conduct a system safety inspection of each delivery vessel engaged in transfer operations in the marine waters of California. Such an inspection should determine whether the vessel is in compliance with equipment, procedures, and other requirements as specified in this Plan.
- Monitoring transfer operations at the transfer site, including monitoring pre-booming requirements.
- Additionally, twice a year equipment deployment drills shall be conducted by the bunker delivery companies in each port to meet the booming requirements.
- The bunker company has successfully demonstrated to the Administrator their ability to deploy and maneuver boom through deployment drills demonstrating the following: sufficient boom, trained personnel and equipment, maintained in a stand-by condition at the point of transfer, such that at least 1200 feet of boom, or an amount sufficient to meet the containment requirements, whichever is greater, can and will be deployed for the most effective containment immediately, but no longer than 30 minutes, after discovery of a spill.

Prior to each transfer operation, the transfer until shall provide, for the duration of the entire transfer operation, either pre-booming or standby booming if the aforementioned requirements are not met. These standards may not reflect the

## Appendix A

exigencies of actual spill response. However, these standards must be used to determine the amount of equipment and personnel that must be available, in such cases pre-booming may be required.

c. **Pre-Booming:\***

Transfer units must carry or provide at the point of transfer appropriate equipment and supplies for the containment and removal of both persistent oil, and #1 and #2 grade oil spills in water adjacent to the transfer site. For pre-booming, the transfer unit shall deploy boom so as to enclose the water surface area adjacent to the receiving unit which will provide common containment area for:

- Either of the following:
  - The entire receiving unit and the point of transfer; or
  - Those portions of the receiving unit or seawall from which oil may spill into the water.
- Where the hull of the transfer unit or seawall is capable of acting as an effective barrier on the side of the receiving unit, the boom on that side may be deployed so that it provides containment of the receiving unit and the transfer unit or seawall.
- The boom shall be periodically checked and the boom position shall be adjusted as necessary throughout the duration of the transfer; especially during tidal changes and significant wind or wave events, to maintain maximum containment in the event that oil is spilled into the water.



# Appendix A

## Anchorage 7 Berth Information

- Two .05NM (100 yard ) Drop Buckets
- Accommodates two vessels
- Vessels should strive to let go anchor in center of drop bucket

ANCHORAGE 7 BERTH COORDINATES  
COORDINATES INDICATE CENTER OF .05NM (100YD) DROP  
BUCKET

Berth	Latitude	Longitude
7N	37° 49.617'N	122° 23.403'W
7S	37° 49.178'N	122° 22.967'W

## Anchorage 8 Berth Information

- Three .05NM (100 yard ) Drop Buckets with .25nm swing circles (8N, 8C, 8S)
- Two .05NM (100 yard) Drop Buckets with .20nm swing circles (8E1, 8E2)
  - Intended for use by smaller, lighter draft vessels; ATBs, Tug/Tow, CG Cutters
- Accommodates up to five vessels
- Vessels should strive to let go anchor in center of drop bucket

ANCHORAGE 8 BERTH COORDINATES  
COORDINATES INDICATE CENTER OF .05NM (100YD) DROP  
BUCKET

Berth	Latitude	Longitude
8N	37° 47.575'N	122° 21.485'W
8C	37° 47.395'N	122° 20.890'W
8S	37° 46.910'N	122° 21.050'W
8E1	37° 47.835'N	122° 21.000'W
8E2	37° 46.905'N	122° 20.480'W

## Anchorage 8A Berth Information

- Only exists when activated by VTS, activated when additional space is needed
- One .05NM (100 yard ) Drop Bucket with .30nm swing circle
- Accommodates one vessel
- Vessel should strive to let go anchor in center of drop bucket

ANCHORAGE 8 BERTH COORDINATES  
COORDINATES INDICATE CENTER OF .05NM (100YD) DROP  
BUCKET

Berth	Latitude	Longitude
8A	37° 47.050'N	122° 21.725'W

sek  
9/8/15

## Appendix A

### New Anchorage 9 Berth Layout Information Sheet

Twenty-four .1NM (200 yard ) Drop Buckets  
 Arranged in three North-South Columns and Eight East/West Rows  
 Spacing: .6NM north/south (1200 yds) between rows, .45NM east/west (900 yds) between columns  
 Western-most column is .25 NM (500 yards) from western boundary  
 Northern-most row is .35 NM (700 yards) from the northern boundary  
 Accommodates twenty-four vessels  
 Vessels should strive to let go anchor in center of drop bucket

ANCHORAGE 9 BERTH COORDINATES		
COORDINATES INDICATE CENTER OF .1NM (200YD) DROP BUCKET		
Berth	Latitude	Longitude
Western Column		
W1	37° 46.149'N	122° 21.504'W
W2	37° 45.562'N	122° 21.305'W
W3	37° 44.972'N	122° 21.104'W
W4	37° 44.332'N	122° 20.886'W
W5	37° 43.747'N	122° 20.688'W
W6	37° 43.159'N	122° 20.488'W
W7	37° 42.578'N	122° 20.289'W
W8	37° 41.991'N	122° 20.092'W
Center Column		
C1	37° 46.125'N	122° 20.935'W
C2	37° 45.539'N	122° 20.376'W
C3	37° 44.948'N	122° 20.535'W
C4	37° 44.305'N	122° 20.317'W
C5	37° 43.719'N	122° 20.118'W
C6	37° 43.131'N	122° 19.919'W
C7	37° 42.550'N	122° 19.723'W
C8	37° 41.961'N	122° 19.524'W
Eastern Column		
E1	37° 46.102'N	122° 20.363'W
E2	37° 45.514'N	122° 20.164'W
E3	37° 44.925'N	122° 19.963'W
E4	37° 44.275'N	122° 19.742'W
E5	37° 43.688'N	122° 19.542'W
E6	37° 43.101'N	122° 19.343'W
E7	37° 42.522'N	122° 19.146'W
E8	37° 41.932'N	122° 18.947'W

•

# Appendix A

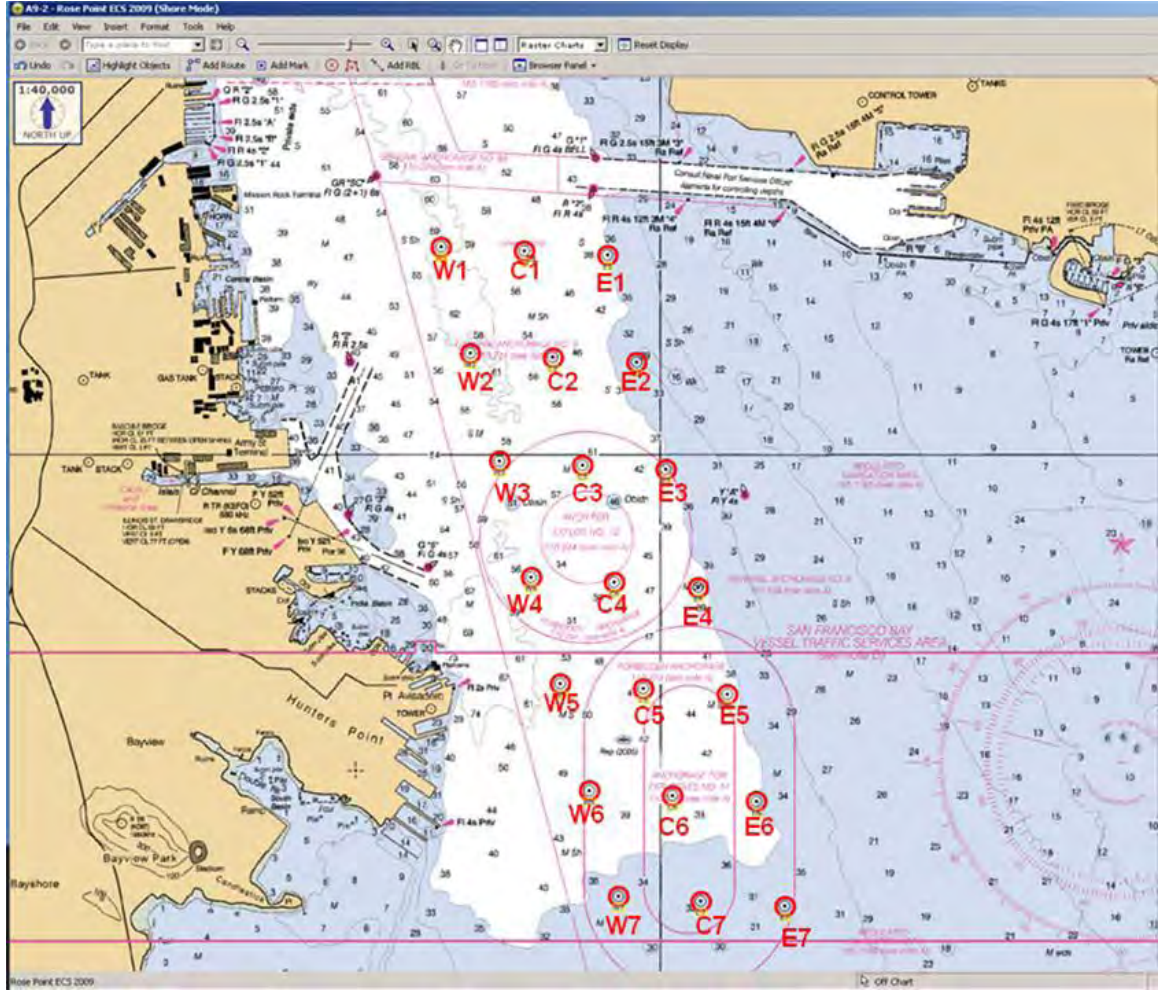

# Appendix A

## Dead Ship Towing

1. **Vessel Representative Responsibilities:** The Vessel Representative of the Dead Ship Tow Project should execute the following measures directly after the Tow has been confirmed.
  - a. Fully review the vessel specifics of the ship to be towed.
  - b. Verify the vessel's seaworthiness and watertight integrity. Items to verify include, but are not limited to, the following:
    - All compartments have been entered and inspected
    - Sea valves are closed or wired shut
    - Bilges are free of oil and water
    - All moveable equipment is secured in place with wire or by welding
    - The rudders are locked by using structural steel of acceptable size and quantity (NOTE: the lock should transfer the rudder load from the yoke to structural members of the tow's hull)
    - The shafts are locked
    - Vents to tanks and other closed spaces should be covered to prevent water entry, but not plugged so as to prevent the escape of air or gas
    - All hatches, scuttles, doors, and other watertight closures are secure
  - c. Complete a Dead Ship Tow Plan to ensure a safe and efficient route that is sure to accommodate navigational clearances, tides/currents, marine projects, and vessel traffic. The tow plan should include but is not limited to the following:
    - Vessel
    - Vessel Type
    - VIN (if applicable)
    - LOA
    - Draft
    - Air Draft
    - Beam
    - Location of origin
    - Vessel's destination
    - POC Name/24hr Phone
    - Weather Conditions
    - Tides/Currents
    - Lead Tug Name and Class
    - Lead Tug Master Name
    - Pilot Designator/Name if Applicable
    - Assist Tugs Name and Class
    - Tug Working Frequency
    - Diagrams of Tow Configurations for Intended Route
    - International voyage plan (if applicable)\*

## Appendix A

\* NOTE: For any dead ship greater than 79 feet LOA or 150 gross tons transiting on a coastwise domestic or international voyage, the vessel will require a single voyage Coastwise Load Line Authorization or an International Load Line Exemption Certificate from the U.S. Coast Guard Sector San Francisco Officer in Charge of Marine Inspections. To obtain a load line exemption certificate, contact the Inspections Division via (510) 437-3444 to schedule a vessel examination. Such requests for inspection should be made a minimum of 30 days in advance of the scheduled towing operation to accommodate scheduling limitations.

- d. Ensure that tugs assigned adhere to the minimum towing capacities listed below

Class	Static Bollard Pull Ahead	Static Bollard Pull Astern
A+*	100,000	100,000
A	85,000	55,000
B	60,000	45,000
C	35,000	20,000
D	20,000	10,000

\* Tractor Tug

Vessel's LOA in Feet	Draft In Feet	Tugs Required
Greater Than 1000	N/A	A+, A+, A+, A+
900 - 1000	Greater than 38'	A+, A+, A+, A+
900 - 1000	Less than 38'	A+, A+, A+, A
750 - 900	All	A+, A+, A, A
550 - 750	All	A, A, B, or A, B, C, C
400 - 550	All	A, B, C
300 - 400	All	B, C
200 - 300	All	C, C
0 - 200	All	C

- e. Develop and employ a towing arrangement that enables the towing vessel(s) to maintain control of the dead ship at all times.
- f. Ensure that the personnel assigned to conduct the tow hold the appropriate licenses in accordance with Title 46, Code of Federal Regulations (CFR), Part 15.

NOTE: It is recommended that a State Licensed Pilot be contracted for all Dead Ship Tows greater than 500 feet LOA transiting through the UP Railroad Bridge.

## Appendix A

- g. Contact Sector San Francisco Waterways Safety via (415) 399-7443 no less than 48 hours prior to the intended Dead Ship Tow to notify them of the intended operation and to verify that a Tow Plan has been completed and is in place.

NOTE: Sector San Francisco Waterways Safety Branch may request to review a copy of the Dead Ship Tow Plan at any time.

### 2. **Vessel Representative/Pilot Responsibilities** : Prior to the commencement of the scheduled tow, the Vessel Representative shall perform the following.

- a. Hold a pre-departure conference with all concerned parties to review the tow plan and discuss the communications protocol to be used during operations .
- b. Be prepared to answer the following questions:
  - Do tugs assigned have the towing capacity to maintain control of the vessel at all times?
  - Do navigational clearances along the proposed route accommodate vessel specifications?
  - Are there any marine projects that would reduce clearances along proposed route?
  - Are the winds forecasted to exceed 25 knots along the intended route?
  - Is visibility less the ½ NM?
  - Does any of the above warrant any deviation from the existing Tow Plan?
- c. Report to Vessel Traffic Service (VTS) San Francisco prior to conducting operations within the VTS Service Area and as dictated upon commencement of the operation in accordance with 33 CFR 161.18.
- d. If special circumstances prevent the vessel or towing personnel from adhering to the best practice guidelines herein, the vessel representative should contact the Sector San Francisco Waterways Safety via (415) 399-7443 to justify deviation(s).

# Appendix A

## **BEST MARITIME PRACTICE- EMERGENCY OFFSHORE TOWING**

### TABLE OF CONTENTS

Section 1: Overview

Section 2: Geographic Scope

Section 3: General Guidelines / Community Responsibilities

Section 4: Vessel/Owner/Operator (RP) Responsibilities

Section 5: Tug Company Responsibilities

Section 6: Appendices

- Appendix A: Offshore Towing Risk Matrix
- Appendix B: SF Bay Tug List [Text Removed; see <http://www.sfm.org/support/hsc/kipsratings/KIPSRatings.html>]
- Appendix C: Emergency Tow Vessel Capability Matrix
- Appendix D: SOLAS regulation II-1/3-4
- Appendix E: Sample Emergency Tow Booklet (ETB)
- Appendix F: Communication Checklist
- Appendix G: Ship Rescue Requirement Checklist
- Appendix H: Tow Configuration Examples

## 1. OVERVIEW

The objective of this Best Maritime Practice is to set forth the Harbor Safety Committee's expectations regarding the planning and execution of emergency towing operations. This BMP provides guidance to ensure that the best towing assets with the most appropriate equipment and properly trained crews are deployed from San Francisco Bay for emergency towing. This BMP has been compiled so that the assigned tug(s) and vessel in distress have a common understanding of what is likely to occur in the event an emergency towing operation is necessary.

The following entities have a role in executing this Best Maritime Practice:

- 1) The San Francisco Harbor Safety Committee – With representatives from within the Maritime Industry, Regulators, Environmentalists, and the general public this organization has proven to be a valuable team to insure all stakeholder interests are represented.
- 2) Vessel Owners/Operators – The companies that operate the vessels that provide the resources to keep our economy moving.
- 3) San Francisco Bay Area-based Tug Companies – The companies that conduct various towing operations on San Francisco Bay and are capable of performing offshore Emergency Ship Towing.

## 2. GEOGRAPHIC SCOPE

The jurisdiction of the Harbor Safety Committee of the San Francisco Bay includes all of the inland Bay waters and extends to the "SF" buoy and the sea approaches to San Francisco Bay east of that point. This BMP is intended to protect the resources within the San Francisco Bay by ensuring that appropriate actions are taken to prevent a drift grounding along the CA coast and the consequent environmental damage, which would ensue both to the coast and possibly to the Bay. The tenets of this BMP apply to emergencies within the Bay, and those outside of San Francisco Bay, which may require the deployment



## Appendix A

of the organic tug assets normally available in San Francisco Bay. The anchorages and dock spaces which may be the final destination for any vessel experiencing a loss of propulsion whether offshore or within the Bay are located within San Francisco Bay, as are many of the Potential Places of Refuge (PPOR). The decision on the final destination for an emergency tow will be made by a Unified Command, defined in Section 3 below.

### 3. GENERAL GUIDELINES / COMMUNITY RESPONSIBILITIES

#### EARLY NOTIFICATION

The USCG has developed a Homeport Alert Warning System for early notification to tug companies of potential offshore emergencies that may require the use of tugs. This early notification is for informational purposes only and allows the industry to begin to assess their equipment and crew capabilities and timelines for an organized potential response. The tug company can greatly reduce the risk to its crews and be more productive preparing the tug while it is in the harbor rather than having crews do the prep work on deck at sea. Once a company is selected by the Responsible Party, response time will be dependent on the urgency of the situation. All tug companies with interest in and capabilities of responding to Emergency Ship Towing situations offshore are encouraged to sign up for and enroll in the Home Port Alert Warning System, which may be done by contacting the Coast Guard.

#### RESPONSE PRIORITY

The Harbor Safety Committee has established the following priority actions for emergency towing situations. Parties should consult closely with the Coast Guard to collaboratively establish specific priorities for each emergency towing incident:

- Triage – assess the situation and send appropriate assets to address the highest concern situation (eg, drift grounding)
- Stabilize – initially stabilize the drifting vessel and isolate it from immediate danger. If adequate assets are not initially available to begin a towing evolution, it may be necessary to send smaller / less powerful assets to temporarily stabilize and hold the vessel.
- Tow – once the highest risk situations have been avoided and the situation is stable, commence tow to gain full control of the situation.
- Identify Destination – Identify a destination for the towed vessel (if applicable). Should the situation warrant use of the PPOR process (as determined by the Coast Guard and/or appropriate Unified Command), begin vetting process for PPOR within the Bay. Note: the typical emergency ship towing scenario will not require use of the PPOR process.

For incidents that occur within the San Francisco Bay, available tug assets will be immediately dispatched to respond to the situation. Due to the traffic density within the Bay, most casualties which result in the need for such assistance occur where adequate tug assistance is immediately available. This BMP outlines the procedures and practices to ensure timely and appropriate response to incidents in the offshore environment.



## Appendix A

The Typical Decision/Action Matrix for Emergency Offshore Towing (**Appendix A**) graphically depicts the risk-based priority for getting tugs underway and on scene outside of the Golden Gate. The Matrix is a tool designed to assist the Coast Guard, vessel operators and towing companies in determining the highest risk areas, and to inform vessel operators of potential actions and expectations of the Coast Guard given the distance offshore. The Matrix does not definitively dictate the boundaries between the areas of highest, medium and low risk, but rather is a tool to enhance risk assessment and decision making. Other factors such as prevailing weather, vessel traffic conditions, and vessel material condition also impact assessment of risk and associated response posture. The goal of any response should be to prevent a vessel from drifting into the highest risk (red) areas without the assistance of adequate tugs to stabilize and control the situation. When an incident occurs further off the coast, where the risk of the vessel drifting near shore is reduced, it is possible and prudent to spend more time preparing a response and tow plan.

Under normal circumstances, the Coast Guard will direct the RP to ensure that adequate tugs to control the situation are in place at the 12nm line. The matrix is designed to prompt action in such a manner as to ensure this safeguard is in place and actionable. The Coast Guard will typically require a minimum two tug escort for vessels entering San Francisco Bay following a loss of propulsion.

### AVAILABLE TOW VESSELS AND RECOMMENDED TOWING EQUIPMENT

An inventory of towing vessels in the San Francisco Bay that may assist a vessel offshore is available on the San Francisco Marine Exchange web site in the Harbor Safety Committee pages, <http://www.sfmex.org/support/hsc/kipsratings/KIPSRatings.htm>. This list identifies tugs which may be available for dispatch to an offshore emergency. The list is for guidance and reference only, since at any given time an individual tug on the list may not be available for various reasons. Specific guidance regarding the appropriate equipment to be carried on a towing vessel is outlined in Section 5 below. The Ship Rescue Requirement Checklist template (**Appendix G**) is recommended to ensure that preparation is thorough.

### EMERGENCY TOW VESSEL CAPABILITY MATRIX

Parties involved in dispatching a rescue tug should refer to the “Emergency Tow Vessel Capability Matrix” (**Appendix C**) in this document as a guide with the understanding that circumstances may warrant the need for additional resources. The matching of rescue tugs to a vessel depends on a multitude of variables. Multiple studies have been completed on this subject and there are many variables which determine a suitable matching of tug quantities and power. The Matrix in Appendix C was compiled by the West Coast Offshore Vessel Traffic Risk Management Project which was co-sponsored by the Pacific States/British Columbia Oil Spill Task Force and the US Coast Guard, Pacific Area. Information was evaluated from five studies from separate sources to develop this Matrix.

### INCIDENT MANAGEMENT/UNIFIED COMMAND

The RP should refer to their applicable emergency response plans to determine their responsibilities and needs. For certain incidents, the Coast Guard may determine the need for a Coast Guard Unified Command (UC) and Incident Command Post (ICP). In the event that either the Vessel Response Plan

## Appendix A

(VRP) indicates the stand-up of a UC or if the Coast Guard determines the need for a UC, the following personnel, at a minimum, should be represented and present within the ICP:

- USCG Federal On Scene Coordinator (USCG FOSC)
- State On Scene Coordinator (SOSC)
- Vessel Representative (RP)
- Applicable Towing Company representative
- Salvage Representative (as applicable under Salvage and Marine Fire Fighting Plan)

### TOW DESTINATION

The vessel owner will work with Federal regulators (and in some cases State regulators and other stakeholders via Unified Command) to gain approval for the destination, taking into consideration the nature of the vessel's casualty and repair needs. The vessel operator, Pilots, or regulators may require additional tugs to be dispatched as the vessel approaches the San Francisco Bay and certain points within the Bay to ensure safe transit.

### CONTINUAL IMPROVEMENT / EXERCISE FREQUENCY

The San Francisco Harbor Safety Committee is committed to partnering for the greater public trust of California shorelines and is committed to conducting drills and exercises to maintain proficiency and to improve best practices. These exercises will provide the Harbor Safety Committee with a sound feedback mechanism on the applicability of this best practice and will allow the best practice an efficient means for continual improvement.

- a. The Tug Work group will organize and execute periodic drilling of Emergency Towing Situations.
  - i. The Tug Workgroup should hold a table top exercise testing the incident response, incident management and response resources no less than twice in 3 years.
  - ii. The Tug Workgroup should also perform a field exercise involving an actual ship with the objective of testing tow gear, techniques and communication, and sharing lessons learned across the local maritime community, no less than once every 3 years.
  - iii. An actual Emergency Ship Tow may count towards drill credit if the towing company involved is willing to present to the Workgroup a review of the actual tow.

## 4. VESSEL/OWNER/OPERATOR (RP) RESPONSIBILITIES

### GENERAL

This Best Maritime Practice is intended to assist owners/operators in preparing their ship for an emergency towing incident. Every Ship Master calling upon San Francisco Bay should review this best practice in its entirety prior to his/her first arrival in San Francisco Bay. Owners, operators and crews

## Appendix A

should take into consideration that the nature of an emergency does not allow much time for deliberation. Accordingly, emergency procedures should be developed and practiced beforehand. The International Maritime Organization has developed Guidelines for owners/operators on preparing emergency towing procedures (MSC.1/Circ.1255) and Guidelines on emergency towing arrangement for tankers (MSC.35(63), as amended) to assist vessels with meeting the requirements of SOLAS regulation II-1/3-4 (**Appendix D**). The IMO has also developed Guidelines for Safe Ocean Towing (MSC/Circ884), which does not apply to salvage or rescue towing services but provides additional guidance which may be useful for towing vessels.

### SHIP EVALUATION

The Master/Crew/Owner/Operator of a vessel should prepare an evaluation to identify their ship's towing capabilities and limitations under various towing configurations. This evaluation/inspection should take into consideration the structure of the ship, the safe working loads of the mooring and ground tackle aboard the ship, the ability to use powered equipment under various casualties, and the equipment aboard the vessel that could be used in an emergency towing situation. Consult SOLAS regulation II-1/3-4 (**Appendix D**) for further details.

### PROCEDURES

In conjunction with the Ship Evaluation, the vessel owner/operator shall develop procedures for making up to a rescue tug. Procedures should be developed for various emergency scenarios taking into consideration scenarios involving an immediate threat of grounding, weather conditions (mild & severe), and non-availability of onboard power. Procedures should be specific to facilitate proper execution by crew members. Diagrams of possible rigging scenarios could be developed into a matrix to allow for rapid identification of a tow plan once a ship finds itself in a specific situation.

### TRAINING

As with any casualty the possibility of a successful outcome is increased if the crew is trained in dealing with such a situation. The ship-specific procedures should be shared with the crew and Emergency Towing Drills should be incorporated into the ship's drill schedule. Through regular drills and post-drill critiques the ship-specific procedures can be updated and improved from lessons learned during training which will further increase the chance of a successful outcome in an emergency situation.

### EMERGENCY TOW BOOK

The inventory gathered during the evaluation process and the resulting procedures should then be documented in a ship-specific Emergency Tow Book (ETB). A sample template of an ETB developed by the IMO is included as **Appendix E**. Vessel Owner/Operators/Agents should have access to this information and be able to immediately distribute it via email to the towing company and to other industry parties participating in the response. Receipt of a copy of the ETB prior to departure on to the distressed vessel will assist the towing companies to more efficiently prepare for the job and is a key factor in the success of the emergency tow.

## Appendix A

### NOTIFICATION

Early notification to the Coast Guard of a vessel casualty is a key element of initiating an effective response. Vessel owners and operators are required to provide notifications to the Coast Guard in accordance with 46CFR4 and 33 CFR 161 (when within the VTS Area).

### COMMUNICATION

In the event of a casualty that may require an emergency tow, time is critical. Early activation of a response by the vessel will decrease the severity of the casualty. Most vessels will never encounter the need to activate such a response, but, if required, the complexity of the situation will be hectic and difficult to relay. The checklist contained in **(Appendix F)** is included in this BMP to serve as a reference for the timely and accurate communication of key information needed to begin a response.

Owners/Operators/Brokers should expedite the decision of which tug company to use so that the tug company can activate its plan.

### VRP ACTIVATION

The RP shall activate their Vessel Response Plan (VRP); and/or their Salvage and Marine Firefighting Plan (SMFFP) as applicable under 33CFR155. The provisions of this BMP are non-regulatory in nature and are complementary guidance to VRPs and SMFFPs. The goal of this BMP is to prevent a drift grounding situation by ensuring that appropriately sized and equipped tugs are dispatched to enact the Emergency Towing requirement of the SMFFP in a timely manner. In the event that either the Vessel Response Plan (VRP) indicates the stand-up of a UC or if the Coast Guard determines that a UC is needed, the RP must have a representative present in the UC.

## 5. TUG COMPANY'S RESPONSIBILITIES

### GENERAL

This Best Maritime Practice is also intended to provide towing companies who may be called upon to respond with guidance to ensure that their tug is prepared to respond safely and effectively. Tug companies intending to engage in emergency ship towing operations are encouraged to review and ensure that their Safety Management System is inclusive of control measures that are applicable to such towing operations.

Each tug company offering emergency towing services should have specific procedures contained in their Safety Management System (SMS), or equivalent Operations Manual. The procedures should include specific requirements for what information, equipment, and crew complement is required for various emergency towing scenarios. The Ship Rescue Requirement Checklist template **(Appendix G)** can be a useful tool in ensuring that preparation is thorough. Making up the vessel to the tug is the largest variable in the towing operation; therefore the tug operators' procedures need to address various possible makeups. **Appendix H** shows examples of possible towing configurations that could be used for an emergency towing operation. Procedures should be divided up, separating tasks that should be completed prior to departure, while underway to the vessel, on scene arrival, and during the tow to the final destination. Job safety should be the number one priority and safety meetings with the crew

## Appendix A

should be held prior to departure and frequently during the operation, specifically including prior to making up to the vessel and after and an on scene risk assessment has been completed.

### TRAINING

It is important not only to have procedures, but also to incorporate those procedures into the tug company's training regimen. Not all the mariners working on tugs regularly handle the gear required to accomplish an emergency tow so it is critical that drills and exercises be held to simulate offshore towing operations. Drills should include a review of procedures for deploying an Orville Hook, use of a line throwing apparatus, deployment of an Emergency Ship Towing System (ESTS), a review of various kinds of ground tackle used in connecting a vessel tow. Tug companies offering Emergency Ship Towing services should participate in the Periodic HSC Emergency Towing Exercises. Tug companies should also attempt to hold training with their customers to incorporate ships into the training to more closely simulate actual responses.

### COMMUNICATION

The USCG Home Port Alert Warning System alerts tug companies of the possibility of an emergency tow and allows them to begin the process of preparation. Swift and timely preparation can save valuable time in the overall response and significantly reduce risk. The USCG Home Port Alert Warning System message is for information purposes only; it does not award the job to a specific tug company. To the maximum extent possible, Owners/Operators/Brokers should expedite the decision of which tug company to use so that company can begin its preparations accordingly.

As soon as a tug company has been selected, it should be sent a copy of the ship's Emergency Tow Book (ETB). After an initial review of the ETB, the tug company should make direct contact with the vessel to discuss the specifics of the casualty using the communication checklist (**Appendix F**) as a reference to ensure that all pertinent information is gathered. A preliminary tow plan should be agreed upon during this communication, such that the vessel and the tug can begin preparations.

This first communication should also establish the primary and back up methods of communication, as well as a schedule of communications between the vessel and the lead tug.

### RISK ASSESSMENT

Tug Companies should conduct a full Risk Assessment prior to getting underway. The Risk Assessment should be conducted with the objective of identifying and implementing any necessary control measures that will reduce the risk to personnel and equipment during the upcoming operation. If the company does not have an official Risk Assessment process in place, the local Coast Guard Sector has several tools available that may assist in this process.

### MANNING

It is the sole responsibility of the tug company to ensure that their tug is crewed adequately. In addition to the minimum manning requirements of 46CFR15, the tug company should ensure that a suitable number of crew, with appropriate training to fulfill their roles on the voyage, are aboard the tug to safely execute the emergency towing operation.

## **Appendix A**

### **EQUIPMENT**

It is up to the towing company to ensure that suitable rescue towing equipment is inventoried, maintained in good working order and is readily available to be deployed. Since the various tug companies employ various equipment packages, a specific equipment list will not be included in the BMP. However, the Ship Rescue Requirement Checklist template (**Appendix G**) can be a useful guide for ensuring that preparation is thorough.

### **DEVELOPING THE TOW PLAN**

The towing company should develop a tow plan consistent with its Safety Management System/Operations Manual and the ship's Emergency Towing Booklet. The tow plan should incorporate the tenets of the Best Practices of Dead Ship Towing as applicable to the situation. Tow plans are intended to be dynamic, allowing for deviations and adjustments as dictated by the changing conditions. Where conditions permit, the tow plan should be drafted and available for review prior to the tug departing for the Emergency Ship Tow.

### **ARRIVING ON SCENE/EVALUATION OF SHIP**

When the tug arrives at the vessel's location the tug Master should circle the ship to check its condition, drafts and trim. Once that is done the Master should stop the tug and lay ahead and then astern of the ship to see how the ship and tug will drift and lay relative to each other when at each location. Keep in mind that different ships will lay to weather, seas and current differently and will drift to the lee side at different rates. If the Master determines that the actual conditions are significantly different than what was identified in the initial risk assessment, the Master should conduct an additional risk assessment and take necessary action to mitigate those risks. .

### **COMMUNICATING THE TOW PLAN**

Once the tug Master establishes his final operational plan for taking the ship under tow, he should provide the ship with a copy so the vessel understands the rigging and what is expected of them in the operation. A final pre-job conference must be held between the Master of the lead tug and the vessel's Master once the vessels are in close proximity to one another. Close radio communications between the tug and ship are crucial to executing a successful tow. Often ships have communication procedures routing all external coms (from the tug) through the ship's bridge and then on to the working deck crew. This can be very challenging. If possible, the Master of the lead tug should request direct communications with the working deck supervisor.

### **EXECUTING THE TOW PLAN**

Once the final tow plan has been communicated to the satisfaction of both Masters, the Tug Master should proceed with the tow connection, ensuring that personnel safety remains the priority.

The Tug Master should now be able to pick the best orientation of his tug relative to the ship and position the tug to make the tow connection. In most cases this will end up being in the lee of the ship's bow, but it depends on the connection method to be used and the sea conditions. If the ship has severe

## **Appendix A**

bow damage, then a stern first tow will have to be considered. The Master should choose the position of the tug which reduces maneuvering and holds the tug at a constant safe distance to the vessel.

If the weather is heavy, the disabled vessel is not in immediate danger of going aground on a lee shore, and it is in the interest of safety, the Master may choose to delay the tow connection until weather and sea conditions improve. Any such decision should be communicated to the Unified Command.

### **TOW ARRANGEMENTS, CONNECTION METHODS AND GEAR**

The ship's connection to the tug's tow gear will depend on the arrangement set forth in the Ship's Emergency Tow Book (ETB). Preferably prior to departure, the tug should obtain a copy of the ship's ETB and talk to the vessel master in order to ensure that the tug's gear is ready to be deployed. (Since every Emergency Ship Tow varies, it is not possible to outline exactly how a tug should connect to a ship. That being said, it is important for Tug Companies to utilize all resources available to them to execute a successful tow.

### **TOWING DESTINATION**

The Tow Plan should include a destination for the ship well before the tug and ship are made up. The vessel owner must work with Federal (and State regulators and other stakeholders as required) to gain approval of the destination taking into consideration the nature of the vessel's casualty and associated repair needs. Vessel owners, Pilots, and/or regulators may require additional tugs or other operational controls as the vessel approaches its destination. Parties should reference the existing Best Maritime Practice for Dead Ship Towing in San Francisco Bay.



# Appendix A

## Appendix A Appendix A to HSC Emergency Offshore Towing BMP

Typical Decision/Action Matrix for Emergency Offshore Towing*			
Response of USCG, OGAs and Port Partners will depend on the position of the vessel in distress in relation to Figure 1: Safety Risk Associated with Vessel Position Offshore. Below are general guidelines for each zone:			
Green Zone "C"	Yellow Zone "B"	Red Zone "A" (Vsl > 12NM)	Red Zone "A" (Vsl < 12NM)
<ol style="list-style-type: none"> <li>Vessel provides casualty notification to USCG.</li> <li>USCG contacts vessel agent/ representative (who should establish communications with the operator/owner).</li> <li>USCG transmits Alert Warning System (AWS) notification as an early warning of the potential need for tug assistance.</li> <li>Vessel/company to affect repairs, notify the USCG of intentions, and request permission to enter port, if applicable.</li> </ol>	<ol style="list-style-type: none"> <li>Vessel provides casualty notification to USCG.</li> <li>USCG contacts vessel agent/ representative (who should establish communications with the operator/owner).</li> <li>USCG transmits Alert Warning System (AWS) notification as an early warning of the potential need for tug assistance.</li> <li>USCG determines if vessel has an approved VRP/SMFF or emergency response system, complying with the International Safety Management Code (SOLAS IX, Reg. 3) and 33 CFR 155.</li> <li>Vessel company to affect repairs, notify the USCG of intentions, and request permission to enter port, if applicable.</li> </ol>	<ol style="list-style-type: none"> <li>Vessel provides casualty notification to USCG.</li> <li>USCG contacts vessel agent/ representative (who should establish communications with the operator/owner).</li> <li>USCG transmits Alert Warning System (AWS) notification as an early warning of the potential need for tug assistance.</li> <li>Vessel should activate VRP/SMFF or emergency response system.</li> <li>USCG review vessel particulars and weather patterns and assess the safety/security risks associated with the vessel.</li> <li>USCG discuss tug assist; ID available tug assets in the area (see VRP/SMFF)</li> <li>Determine set &amp; drift (SAROPS/NOAA)</li> <li>USCG may issue a COTP Order requiring vessel to:               <ol style="list-style-type: none"> <li>Activate VRP/SMFF.</li> <li>Develop and submit a tow plan, and/or salvage plan, with a schedule of operational intention to ensure tugs on-scene at 12nm.</li> <li>Affect repairs and notify the USCG of intentions.</li> </ol> </li> </ol>	<ol style="list-style-type: none"> <li>Vessel provides casualty notification to USCG.</li> <li>USCG contacts vessel agent/ representative.</li> <li>USCG transmits Alert Warning System (AWS) notification as an early warning of the potential need for tug assistance.</li> <li>Vessel should activate VRP/SMFF or emergency response system.</li> <li>USCG reviews vessel particulars and weather patterns and assess the safety/security risks associated with the vessel.</li> <li>USCG discuss tug assist; ID available tug assets in the area (see VRP/SMFF).</li> <li>Determine set &amp; drift (SAROPS/NOAA)</li> <li>USCG will typically issue a COTP Order requiring vessel to:               <ol style="list-style-type: none"> <li>Activate VRP/SMFF.</li> <li>Develop and submit a tow plan, and/or salvage plan.</li> <li>Affect repairs and notify the USCG of intentions.</li> </ol> </li> </ol>

### Considerations:

- Evaluate ANOA- crew, cargoes, fuel, casualty history etc.
- Determine potential impact based on vessel particulars, cargo, fuel on board.
- Establish comms schedule w/ vessel (VTS/SCC)
- Discuss Admin Order (EEZ) and/or COTP Order
- ID environmentally sensitive areas (ACP)
- Does vessel have approved SMFF or VRP?
- Request copy of Emergency Towing Booklet (ETB)
- Engage pilots, CA stakeholders etc.
- Monitor weather & sea state, tides
- ID Potential Places of Refuge
- Potential to federalize response if RP fails to act.

\*Note: These are general guidelines only. Each response is unique and may deviate from the above guidelines on a case by case basis.



# Appendix A

## Appendix A to HSC Emergency Offshore Towing BMP

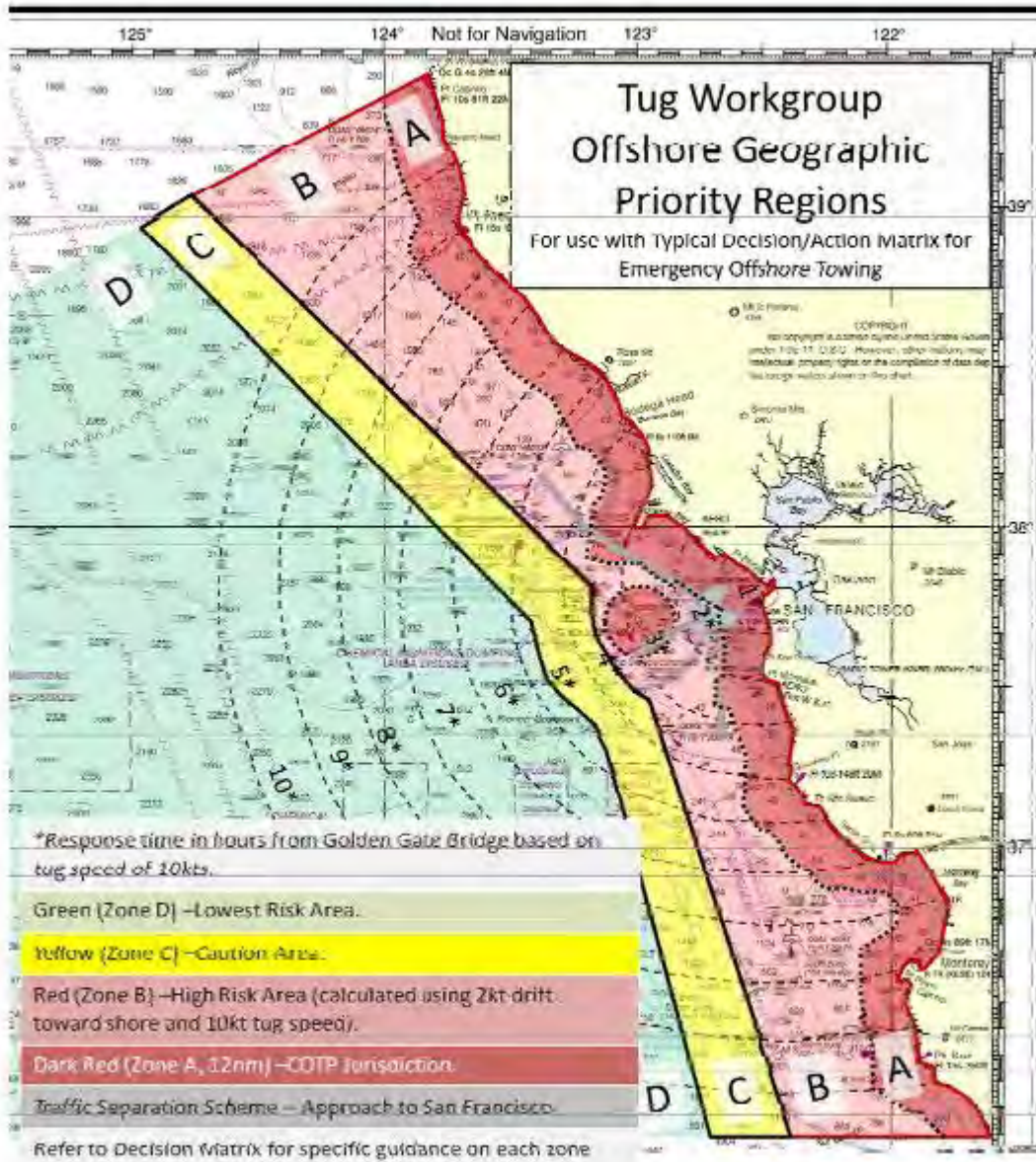

**Figure 1: Safety Risk Associated with Vessel Position Offshore**

## Appendix A

## Appendix C

**EMERGENCY TOW VESSEL CAPABILITY MATRIX (BOLLARD PULL IN TONS)**

<i>Study</i>	<i>Assisted Vessel Type/Size (deadweight tons)</i>	<i>Moderate Weather Seas 10-20', Winds 20-40 kts.</i>	<i>Very Rough Weather Seas &gt; 20', Winds &gt; 40 kts.</i>
Washington State Office of Marine Safety (Allan) Emergency Towing System Task Force Report, 1994 <sup>1</sup>	All Types up to 180,000 Tons	100	150
Canadian Council of Ministers of the Environment (Allan & Dickins) A Review of Escort, Rescue and Salvage towing Capability in Canadian Waters, 1995 <sup>2</sup>	265,000 Ton Tanker	42 (South BC) – 70 (North BC) South BC = West Coast of Vancouver Island North BC = Queen Charlottes & North	120 (South BC) – 220 (North BC)
Alaska Department of Environmental Conservation Best Achievable Technology, 1997 <sup>3</sup>	265,000 Ton Tanker	Not Addressed	90-125
Enhanced Puget Sound International Tug of Opportunity System (ITOS), 1998 <sup>4</sup>	<u>Tanker/Bulker</u> <40,000 40,000 – 75,000 75,000 – 125,000 125,000 – 250,000 <u>Container/Cruise/Car Carrier</u> <40,000 40,000 – 75,000 75,000 – 125,000 125,000 – 250,000 <u>Reefer/RORO/Log</u> <40,000 40,000 – 75,000 <u>Fishing</u> <40,000	35-39 40-59 >60 >60 >60 40-59 >60 >60 >60 >60 35-39 40-59	40-59 >60 >60 >60 >60 >60 >60 >60 40-59 >60
United Kingdom Emergency Towing System, 1998 <sup>5</sup>	265,000 Ton Tanker	Not Addressed	125

<sup>1</sup> Worst Case Planning. Planning factor was the capability to effectively respond to 99% of vessels adrift in severe conditions (slightly less than Very Rough above).

<sup>2</sup> Worst Case Planning. Planning factor was the capability to effectively respond to 94% of vessels adrift in severe conditions (slightly less than Very Rough above).

<sup>3</sup> Worst Case Planning. Planning factors based on tank vessel and tow vessel operator experience and actual towing tests.

<sup>4</sup> All Case Planning. Planning factors based on tow vessel operator experience.

<sup>5</sup> Worst Case Planning. Planning factors based on actual emergency towing experience.

# Appendix A

## Rescue Vessel Equipment Requirements and Procedures

The process of performing a successful rescue of a disabled vessel, whether its mission is to hook up and stabilize the vessel and arrest its drift, or to actually hook up and tow the disabled vessel, is dependent upon a multitude of factors including the type and size of disabled vessel to be rescued; the existing weather and sea conditions the size, horsepower (bollard pull), propulsions and standard towing equipment available, and the urgency of the situation in terms of location and distance from shore.

- The basic equipment requirements for performing a rescue would typically include:
  1. 600' of 8" polypropylene float line;
  2. a line throwing gun;
  3. 1 ea 150X2 ¼" wire pendants;
  4. Orville Hook or special towing shackle which could choke the ship's anchor chain;
  5. 250' X 14" nylon shock line;
  6. 400' X 1 1/4" wire
- If all of the above equipment is not available, an oceangoing tugboat will typically have 7" to 7 ½" deck lines, a winch and tow wire, and/ or Orville Hook that can be used to hook up to a disabled vessel's anchor chain to provide interim assistance and arrest its drift, until such time as a suitable rescue vessel arrives to provide rescue towing assistance
- Providing the disabled vessel has a source of power and sea conditions allow, a rescue hook-up would involve the following steps:
  1. Ship passes an appropriate deck line to the tug and hoists up 1 ea 150' X 2 ¼" wire pennant which is connected to the rescue vessel's surge chain which are connected to the rescue vessel's tow wire--- a 250' X 14" nylon shock line or the 10" shock lines can be used in addition to or in place of the rescue vessel's surge chain.
  2. If the disabled vessel doesn't have power and sea conditions allow, the rescue vessel will lay alongside the disabled vessel and pass the polypropylene line or hard wire utilizing the rescue vessel's winch, or;
  3. The rescue vessel will utilize an Orville Hook or a special towing shackle which can securely choke a ship's anchor chain to make a secure connection to the ship's anchor chain;
  4. If urgency is not an issue and there is an adequate amount of time, the rescue vessel running gear will be utilized to draw the ship's anchor chain to the work deck of the rescue tug and the tugs surge chain will be connected to the anchor chain which ultimately will be connected to the rescue vessel's tow wire.

## **Appendix A**

### **Appendix I**

#### **Rescue Vessel Equipment Requirements and Procedures**

#### **EMERGENCY TOW VESSEL CAPABILITY MATRIX**

INTERNATIONAL MARITIME ORGANIZATION  
4 ALBERT EMBANKMENT  
LONDON SE1 7SR

Telephone: 020 7735 7611  
Fax: 020 7567 3210



IMO

Ref: T4/3.01

MSC.1/Circ.1255  
27 May 2008

## GUIDELINES FOR OWNERS/OPERATORS ON PREPARING EMERGENCY TOWING PROCEDURES

1 The Maritime Safety Committee, at its eighty-fourth session (7 to 16 May 2008), following a recommendation of the fiftieth session of the Sub-Committee on Ship Design and Equipment, approved Guidelines for owners/operators on preparing emergency towing procedures, set out in the annex, aimed at assisting owners/operators in preparing ship-specific emergency towing procedures for ships subject to SOLAS regulation II-1/3-4.

2 The Guidelines are intended to help owners/operators to carry out the necessary steps in establishing emergency towing procedures, provide information on the scope of the emergency towing booklet and give guidance towards creating procedures for towage.

3 The procedures developed by means of these Guidelines aim at supporting the crew in establishing the safest and most efficient course of action to be taken when confronted with an emergency that requires towing.

4 Member Governments are invited to bring the annexed Guidelines to the attention of all parties concerned for application in conjunction with SOLAS regulation II-1/3-4 (Emergency towing arrangements and procedures).

\*\*\*

I:\CIRC\MSC\01\1255.doc



## ANNEX

### GUIDELINES FOR OWNERS/OPERATORS ON PREPARING EMERGENCY TOWING PROCEDURES

#### 1 PURPOSE

The purpose of these Guidelines is to assist owners/operators in preparing ship-specific emergency towing procedures for ships subject to SOLAS regulation II-1/3-4. The procedures should be considered as part of the emergency preparedness required by paragraph 8 of part A of the International Safety Management (ISM) Code.

#### 2 OBSERVATIONS

2.1 Owners, operators and crews should take into consideration that the nature of an emergency does not allow time for deliberation. Accordingly, the procedures should be practiced beforehand.

2.2 The towing procedures should be maintained on board the ship for ready use by the ship's crew in preparing their ship for towage in an emergency.

2.3 The crew should have good knowledge of equipment stowage location and accessibility. Any identified improvements to stowage arrangements should be implemented.

2.4 Crew dealing with an emergency situation should be aware of power availability required for winches and tools, as well as for deck lighting (for bad/low visibility and night time situations).

2.5 It is recognized that not all ships will have the same degree of shipboard equipment, so that there may be limits to possible towing procedures. Nevertheless, the intention is to predetermine what can be accomplished, and provide this information to the ship's crew in a ready-to-use format (booklet, plans, poster, etc.).

#### 3 SHIP EVALUATION

3.1 The owner/operator should ensure that the ship is inspected and its capability to be towed under emergency situations is evaluated. Both equipment on board and available procedures should be reviewed. Items that need to be inspected are described in the following paragraphs.

3.2 The ability of the ship to be towed from bow and stern should be evaluated, and the following items should be reviewed:

- .1 line handling procedures (passing and receiving messenger lines, toelines, bridles); and
- .2 layout, structural adequacy and safe working loads of connection points (fairleads chocks, winches, bits, bollards), etc.

# Appendix A

MSC.1/Circ.1255

ANNEX

Page 2

3.3 The on-board tools and equipment available for assembling the towing gear and their locations should be identified. These should include but not be limited to:

- .1 chains;
- .2 cables;
- .3 shackles;
- .4 stoppers;
- .5 tools; and
- .6 line throwing apparatus.

3.4 The availability and characteristics of radio equipment on board should be identified, in order to enable communication between deck crew, bridge and the towing/salvage ship.

3.5 Unless the safe working loads of connection points are known, these loads should be determined by an engineering analysis reflecting the on-board conditions of the ship. The Guidance on shipboard towing and mooring equipment (MSC/Circ.1175) may be used for guidance.

3.6 The evaluation should be performed by persons knowledgeable in towing equipment and operations.

## 4 EMERGENCY TOWING BOOKLET

4.1 The Emergency Towing Booklet (ETB) should be ship specific and be presented in a clear, concise and ready-to-use format (booklet, plan, poster, etc.).

4.2 Ship-specific data should include but not be limited to:

- .1 ship's name;
- .2 call sign;
- .3 IMO number;
- .4 anchor details (shackle, connection details, weight, type, etc.);
- .5 cable and chain details (lengths, connection details, proof load, etc.);
- .6 height of mooring deck(s) above base;
- .7 draft range; and
- .8 displacement range.

I:\CIRC\MSC\01\1255.doc

# Appendix A

4.3 All procedures developed in accordance with section 5 should be presented in a clear and easy to understand format, which will aid their smooth and swift application in an emergency situation.

4.4 Comprehensive diagrams and sketches should be available and include the following:

- .1 assembly and rigging diagrams;
- .2 towing equipment and strong point locations; and
- .3 equipment and strong point capacities and safe working loads (SWLs).

4.5 A copy should be kept at hand by the owners/operators in order to facilitate the passing on of information to the towage company as early as possible in the emergency. A copy should also be kept in a common electronic file format, which will allow faster distribution to the concerned parties.

4.6 A minimum of three copies should be kept on board and located in:

- .1 the bridge;
- .2 a forecastle space; and
- .3 the ship's office or cargo control room.

## 5 DEVELOPING PROCEDURES

5.1 Ship-specific procedures should be identified during the ship's evaluation and entered accordingly in the ETB. The procedures should include, as a minimum, the following:

- .1 a quick-reference decision matrix that summarizes options under various emergency scenarios, such as weather conditions (mild, severe), availability of shipboard power (propulsion, on-deck power), imminent danger of grounding, etc.;
- .2 organization of deck crew (personnel distribution, equipment distribution, including radios, safety equipment, etc.);
- .3 organization of tasks (what needs to be done, how it should be done, what is needed for each task, etc.);
- .4 diagrams for assembling and rigging bridles, tow lines, etc., showing possible emergency towing arrangements for both fore and aft. Rigged lines should be lead such that they avoid sharp corners, edges and other points of stress concentration;
- .5 power shortages and dead ship situations, which must be taken into account, especially for the heaving across of heavy towing lines;



# Appendix A

MSC.1/Circ.1255  
ANNEX  
Page 4

- .6 a communications plan for contacting the salvage/towing ship . This plan should list all information that the ship's master needs to communicate to the salvage/towing ship. This list should include but not be limited to:
  - .1 damage or seaworthiness;
  - .2 status of ship steering;
  - .3 propulsion;
  - .4 on deck power systems;
  - .5 on-board towing equipment;
  - .6 existing emergency rapid disconnection system;
  - .7 forward and aft towing point locations;
  - .8 equipment, connection points, strong points and safe working loads (SWL);
  - .9 towing equipment dimensions and capacities; and
  - .10 ship particulars;
- .7 evaluation of existing equipment, tools and arrangements on board the ship for possible use in rigging a towing bridle and securing a towline;
- .8 identification of any minor tools or equipment providing significant improvements to the "towability" of the ship;
- .9 inventory and location of equipment on board that can be used during an emergency towing situation;
- .10 other preparations (locking rudder and propeller shaft, ballast and trim, etc.); and
- .11 other relevant information (limiting sea states, towing speeds, etc.).

---

I:\CIRC\MSC\01\1255.doc

**EMERGENCY TOWING BOOKLET**

(in accordance with SOLAS Ch.II-1, Reg.3-4)

SHIP NAME : M/V "ABCD"

Owner name

## Appendix A

### - Table of Contents -

<b><u>Chapter 1 - GENERAL DESCRIPTION</u></b> .....	<b>140</b>
<u>1.1 General</u> .....	140
<u>1.2 Limitation during towing operation</u> .....	140
<u>1.3 Master's response</u> .....	141
<u>1.4 Safety considerations</u> .....	141
<u>1.5 Towing preparations</u> .....	142
<b><u>Chapter 2 - SHIP SPECIFIC DATA</u></b> .....	<b>143</b>
<u>2.1 General information</u> .....	143
<u>2.2 Draft and displacement range</u> .....	143
<u>2.3 Anchor, anchor chain and mooring lines</u> .....	144
<u>2.4 Radio equipment</u> .....	144
<u>2.5 Power supply and steering equipment</u> .....	144
<u>2.6 Lifting devices</u> .....	145
<u>2.7 Deck tools and other equipment</u> .....	145
<u>2.8 Mooring &amp; Towing fittings on fore mooring deck</u> .....	146
<u>2.9 Mooring &amp; Towing fittings on aft mooring deck</u> .....	148
<b><u>Chapter 3 - ORGANIZATION OF TASKS</u></b> .....	<b>150</b>
<u>3.1 Staff arrangement and communication</u> .....	150
<u>3.2 Tasks and equipment</u> .....	151
<b><u>Chapter 4 - TOWING PATTERNS</u></b> .....	<b>152</b>
<u>4.1 General</u> .....	152
<u>4.2 Towing from bow</u> .....	152
<u>4.3 Towing from stern</u> .....	155
<b><u>Chapter 5 - DECISION MATRIX</u></b> .....	<b>158</b>
<u>5.1 Decision matrix for determining towing pattern</u> .....	158

## Appendix A

<a href="#">5.2</a>	<a href="#">Decision matrix (if ETS is not fitted)</a> .....	158
<a href="#">5.3</a>	<a href="#">Decision matrix (if ETS is fitted)</a> .....	158

### **Chapter 6 - PROCEDURES FOR CONNECTING TOWING LINES..... 159**

<a href="#">6.1</a>	<a href="#">General</a> .....	159
<a href="#">6.2</a>	<a href="#">Towing from bow (Pattern F1 – if on-deck power is available)</a> .....	160
<a href="#">6.3</a>	<a href="#">Towing from bow (Pattern F1 – if on-deck power is NOT available)</a> .....	162
<a href="#">6.4</a>	<a href="#">Towing from stern (Pattern A1)</a> .....	164
<a href="#">6.5</a>	<a href="#">Towing from bow (Pattern F3)</a> .....	165
<a href="#">6.6</a>	<a href="#">Towing from stern (Pattern A3)</a> .....	169

### **Chapter 7 - CURRENT STATUS ..... 171**

<a href="#">7.1</a>	<a href="#">General</a> .....	171
<a href="#">7.2</a>	<a href="#">Damage and seaworthiness</a> .....	172
<a href="#">7.3</a>	<a href="#">Steering and propulsion</a> .....	173
<a href="#">7.4</a>	<a href="#">Power system</a> .....	173

# Appendix A

## GENERAL DESCRIPTION

### General

This booklet is prepared for use in emergency towing situations in accordance with SOLAS Ch.II-1, Regulation 3-4 and related MSC.1/Circ.1255.

The following information is included in this booklet:

- a) Drawings of fore and aft deck showing possible emergency towing arrangements;
- b) Inventory of equipment on board that can be used for emergency towing;
- c) Means and methods of communication;
- d) Sample procedures to facilitate the preparation for and conducting of emergency towing;
- e) Organization of tasks; and
- f) Communication plan listing all information that is required to be communicated to the towing ship.

A copy of this booklet should be kept at hand by the owners/operators. A copy should be also kept in a common electronic file format, which will allow faster distribution to the concerned parties.

A minimum of three copies should be kept on board and located in the following locations:

- a) The bridge;
- b) A forecastle space; and
- c) The ship's office or cargo control room.

Owners, operators and crew should take into consideration that the nature of an emergency does not allow time for deliberation. Accordingly, the procedures should be practiced beforehand.

Typical procedures for connecting towing lines are introduced in Chapter 6 of this booklet.

### Limitation during towing operation

Not all ships have the same degree of shipboard equipment, so that there may be limits to possible towing procedures. Nevertheless, the intention of this booklet is to predetermine what can be accomplished.

The towing load should not exceed the safety working loads of deck fittings as shown in 2.8 and 2.9 of this booklet. When heavy weather which will significantly increase the towing load is

## Appendix A

forecasted, special considerations are to be paid to the towing speed, towing line arrangement, and ship's stability.

The loading points on stand-rollers are so high that great bending moments are generally transferred to the supporting structures. Consequently, stand-rollers are not to be used in towing line arrangement as far as practicable.

### Master's response

The master of a ship or shipowner's representative, when recognizing that the ship is in distress and may need towing assistance, should make the initial notification of the incident to the following parties:

- a) Nearest port states;
- b) Flag states; and
- c) Other relevant parties (shipper, insurer, etc.).

The master should complete the tables in Chapter 7 'CURRENT STATUS', and prepare to communicate with the towing ship.

All information from Chapter 1 to Chapter 7 of this booklet should be delivered to the towing ship.

The master should ensure that towing lines do not become taut until towing lines are tied to the connection system of towing ship and that everyone on deck have been notified.

When the power system on board is not available or alternative connection procedures are introduced by the towing ship, the master should try to make a best decision possible considering the ship's current status in consultation with the towing ship.

When an alternative procedure is adopted, it should be well informed to all staff.

The master should ensure that survival crafts are made ready for use.

### Safety considerations

The Chief Officer on the mooring deck should be in contact with the Bridge at all times.

Everyone on deck should be equipped with personnel life saving appliances and be alert to avoid hazardous situations such as slips, trips, fall, etc.

All crew should be well informed of the work procedures and tasks.

When the towing line becomes strained in tension, all on-deck staff should be evacuated to a safe location.

The crew should have a good knowledge about the equipment stowage location and its accessibility. Any identified improvements to stowage arrangements should be implemented.

Whilst engaged in towing operations, the minimum number of crew essential to carry out duties is to be on deck, and they should never be exposed to a rope or wire under tension or load. Wherever possible, the deck should be cleared of crew whilst towing.

## **Appendix A**

### **Towing preparations**

It is recommended that the towed ship is to display the navigation lights, shapes and, if manned, make sound signals required by the International Regulation for Preventing Collisions at Sea, 1972, as amended. Due consideration should be given to the reliability of the lights and sound signals and their ability to function for the duration of the voyage.

Prior to sailing, the watertight integrity of the towed ship should be confirmed by an inspection of the closing arrangement for all hatches, valves, air pipes, and other openings through which water might enter. It should also be confirmed that any watertight doors or other closing arrangements within the hull are securely closed and that any portable closing plates are in place.

The securing arrangements and weather protection for the cargo, equipment and store carried on the towed ship should be carefully examined to ensure that they are adequate for the voyage.

When appropriate, the rudder should be secured in the amidships position and measures should be taken to prevent the propeller shaft from turning.

The towed ship should be at a suitable draught for the intended voyage.

The towed ship should have adequate intact stability in all the loading and ballast conditions to be used during the voyage.

Life saving appliances in the form of lifejackets and lifebuoys should be provided whenever personnel are likely to be on board the towed ship even if only for short periods of time. When personnel are expected to remain on board for longer periods of time, life rafts should be provided. Other life saving appliances, including distress signals, fire appliances and radio equipment, including means of communication with the towing ship, should be provided whenever the towed ship is continually manned.

## Appendix A

### SHIP SPECIFIC DATA

#### General information

1	Ship's name		
2	Call sign		
3	Type of ship		
4	IMO number		
5	Flag		
6	Port of registry		
7	Classification		
8	Classification ID No.		
9	Year of built		
10	Ship Yard		
11	Yard Hull No.		
12	Gross tonnage		
13	Principal dimensions	LOA	
		LBP	
		Breadth	
		Depth	
14	Height of mooring deck at centerline above base line	Fore deck	
		Aft deck	
15	Is emergency towing system(ETS) fitted?	<u>Fore deck</u> <input type="checkbox"/> Yes <input type="checkbox"/> No	<b>Particulars</b>
		<u>Aft deck</u> <input type="checkbox"/> Yes <input type="checkbox"/> No	<b>Particulars</b>

#### Draft and displacement range

	Draft [meters]	Displacement [tons]
Full load condition		
Lightest sea going condition		



## Appendix A

### Anchor, anchor chain and mooring lines

Equipment Number		Anchor	
		Type	
Mooring lines		Weight	
Type		Number	
Diameter		Anchor chain	
Length		Grade	
Number		Length	
Min. Breaking Load		Diameter	

### Radio equipment

No.	Equipment	Fitted or not	Phone No. etc.
1	VHF radio installation	<input type="checkbox"/> Yes <input type="checkbox"/> No	
2	MF radio installation	<input type="checkbox"/> Yes <input type="checkbox"/> No	
3	MF/HF radio installation	<input type="checkbox"/> Yes <input type="checkbox"/> No	
4	Inmarsat – B	<input type="checkbox"/> Yes <input type="checkbox"/> No	
5	Inmarsat – C	<input type="checkbox"/> Yes <input type="checkbox"/> No	
6	Inmarsat – F	<input type="checkbox"/> Yes <input type="checkbox"/> No	
7	Navtex receiver	<input type="checkbox"/> Yes <input type="checkbox"/> No	
8	2-way VHF radio telephone (3EA)	<input type="checkbox"/> Yes <input type="checkbox"/> No	
9	Weather facsimile	<input type="checkbox"/> Yes <input type="checkbox"/> No	
10	Maritime telephone	<input type="checkbox"/> Yes <input type="checkbox"/> No	
11	Portable Wireless Radio	<input type="checkbox"/> Yes <input type="checkbox"/> No	
12			

### Power supply and steering equipment

No.	Equipment	Location	Particulars
1	Main generator		
2	Em'cy generator		
3	Main steering gear pump		
4	Em'cy steering gear pump		
5	When all power supplies are halted, manual steering is possible?		<input type="checkbox"/> Yes <input type="checkbox"/> No

## Appendix A

### Lifting devices

	Device	SWL [tons]	Location
Fore mooring deck	Rope handing davit		
	Portable davit		
Aft mooring deck	Provision crane		
	Fuel oil hose handling davit		
	S/G Room Davit		

### Deck tools and other equipment

No.	Equipment	Location	Particulars
1	Stopper Chain		
2	Shackle for the above and sling wire for connecting hawser		
3	Sledgehammer, bar, hand hammer and knife		
4	Stopper Rope		
5	Pin punch for joining shackle		
6	Seizing wire or Sprit Pin		
7	Life line throwing apparatus		
8			

# Appendix A

## Mooring & Towing fittings on fore mooring deck

**FOR EXAMPLE**

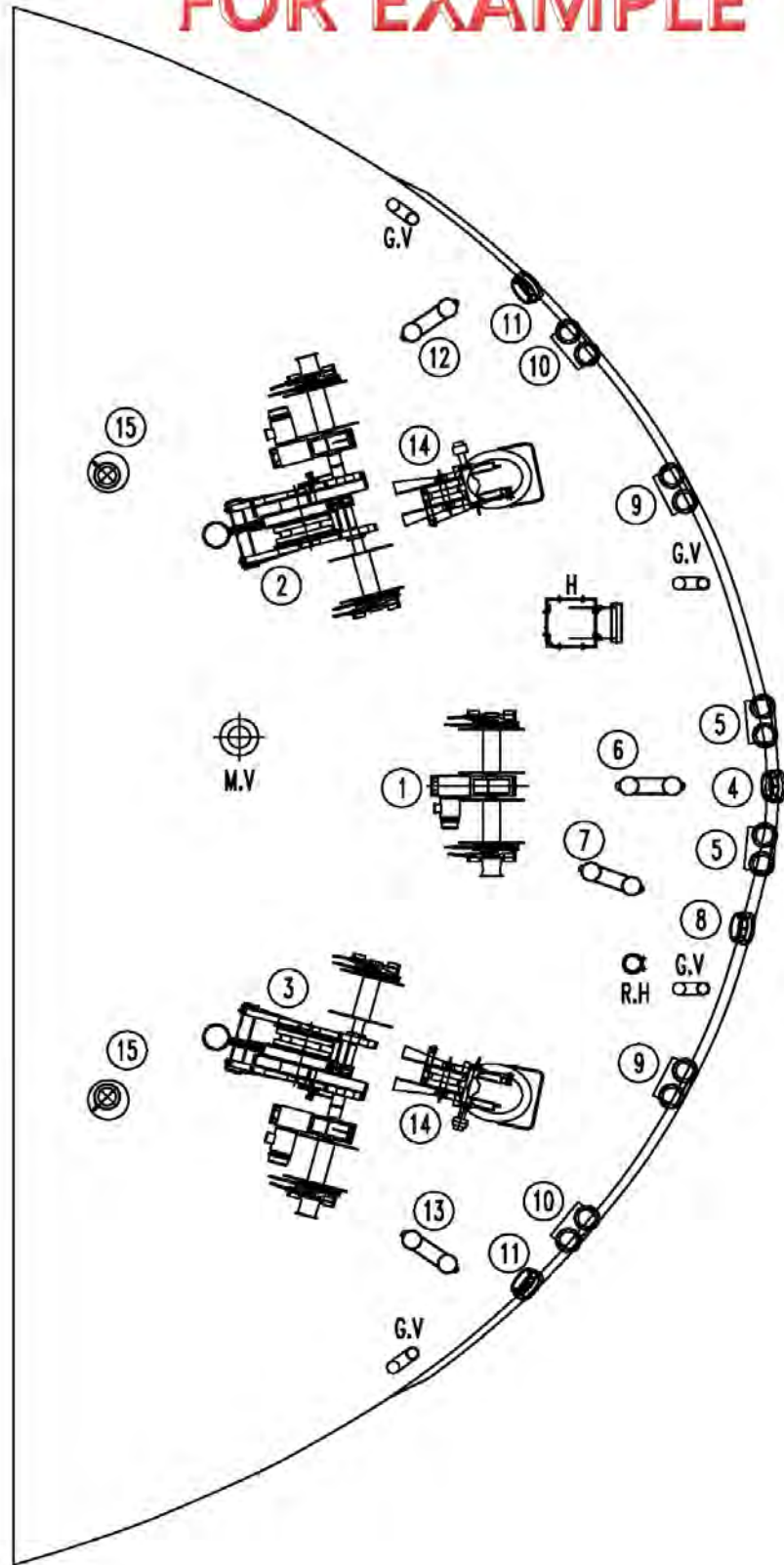

## Appendix A

No.	Deck fittings	Particulars	SWL [tons]
①	Mooring winch(C)	25 ton x 15m/min	-
②	Windlass(P)	40 ton x 9m/min	-
③	Windlass(S)	40 ton x 9m/min	-
④	Panama chock	A-type 360x260	64
⑤	2-Roller fairlead	A- type, Ø350	64
⑥	Bollard	A- type, Ø400	64
⑦	Bollard	A- type, Ø400	64
⑧	Bollard	A- type, Ø400	64
⑨	2-Roller fairlead	A- type, Ø350	64
⑩	2-Roller fairlead	A- type, Ø350	64
⑪	Panama chock	A-type 360x260	64
⑫	Bollard	A- type, Ø400	64
⑬	Bollard	A- type, Ø400	64
⑭	Chain compressor	Roller-type	64
⑮	Pedestal fairlead	A- type, Ø400	64
*The SWL of bollard is based on towing eye splice use.			

# Appendix A

## Mooring & Towing fittings on aft mooring deck

**FOR EXAMPLE**

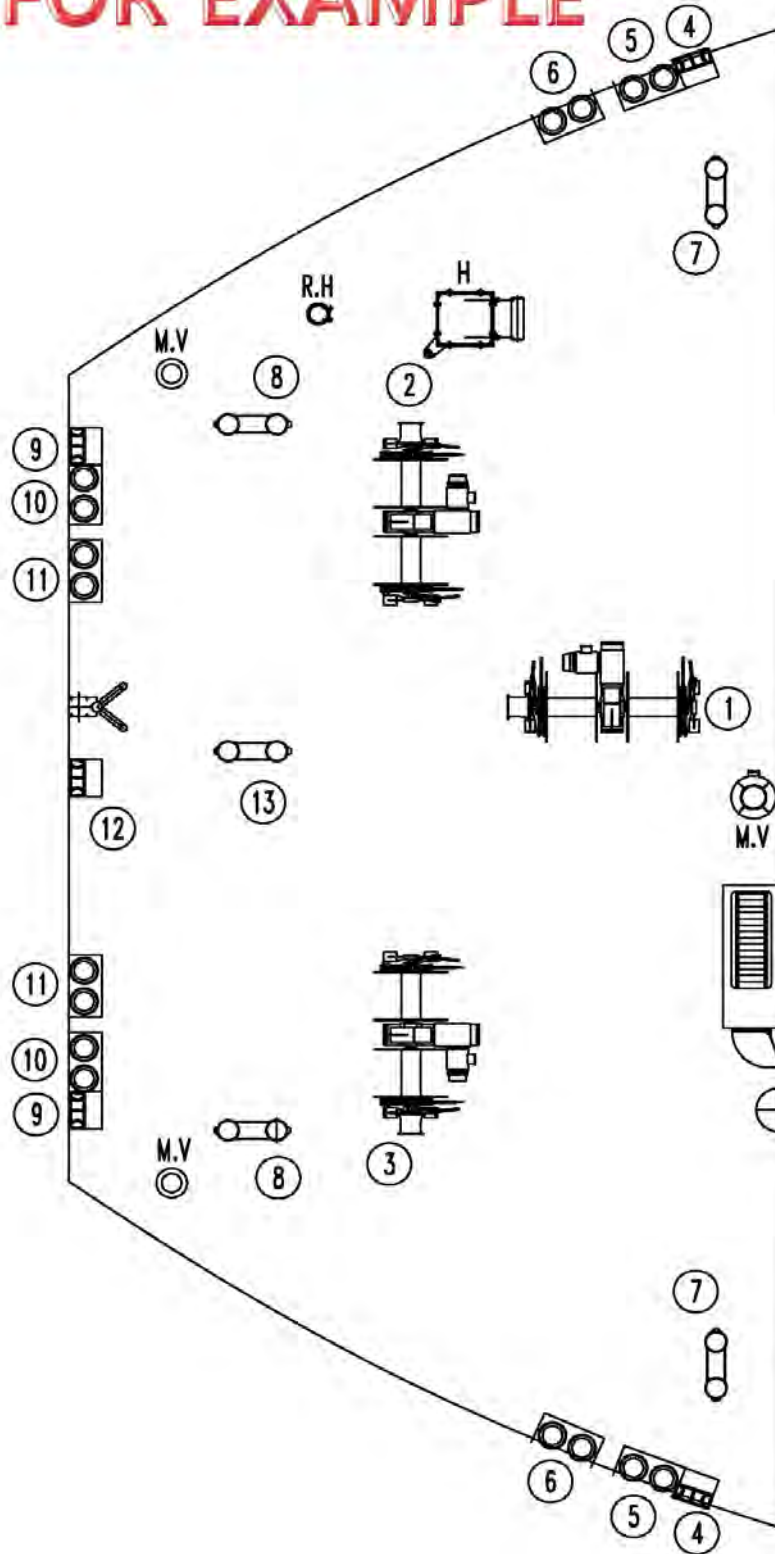

## Appendix A

No.	Deck fittings	Particulars	SWL [tons]
①	Mooring winch(C)	25 ton x 15m/min	-
②	Mooring winch(P)	25 ton x 15m/min	-
③	Mooring winch(S)	25 ton x 15m/min	-
④	Panama chock	A-type 360x260	64
⑤	2-Roller fairlead	A- type, Ø350	64
⑥	2-Roller fairlead	A- type, Ø350	64
⑦	Bollard	A- type, Ø400	64
⑧	Bollard	A- type, Ø400	64
⑨	Panama chock	A-type 360x260	64
⑩	2-Roller fairlead	A- type, Ø350	64
⑪	2-Roller fairlead	A- type, Ø350	64
⑫	Panama chock	A-type 360x260	64
⑬	Bollard	A- type, Ø400	64
⑭	Bollard	A- type, Ø400	64
⑮			
*The SWL of bollard is based on towing eye splice use.			

# Appendix A

## ORGANIZATION OF TASKS

### Staff arrangement and communication

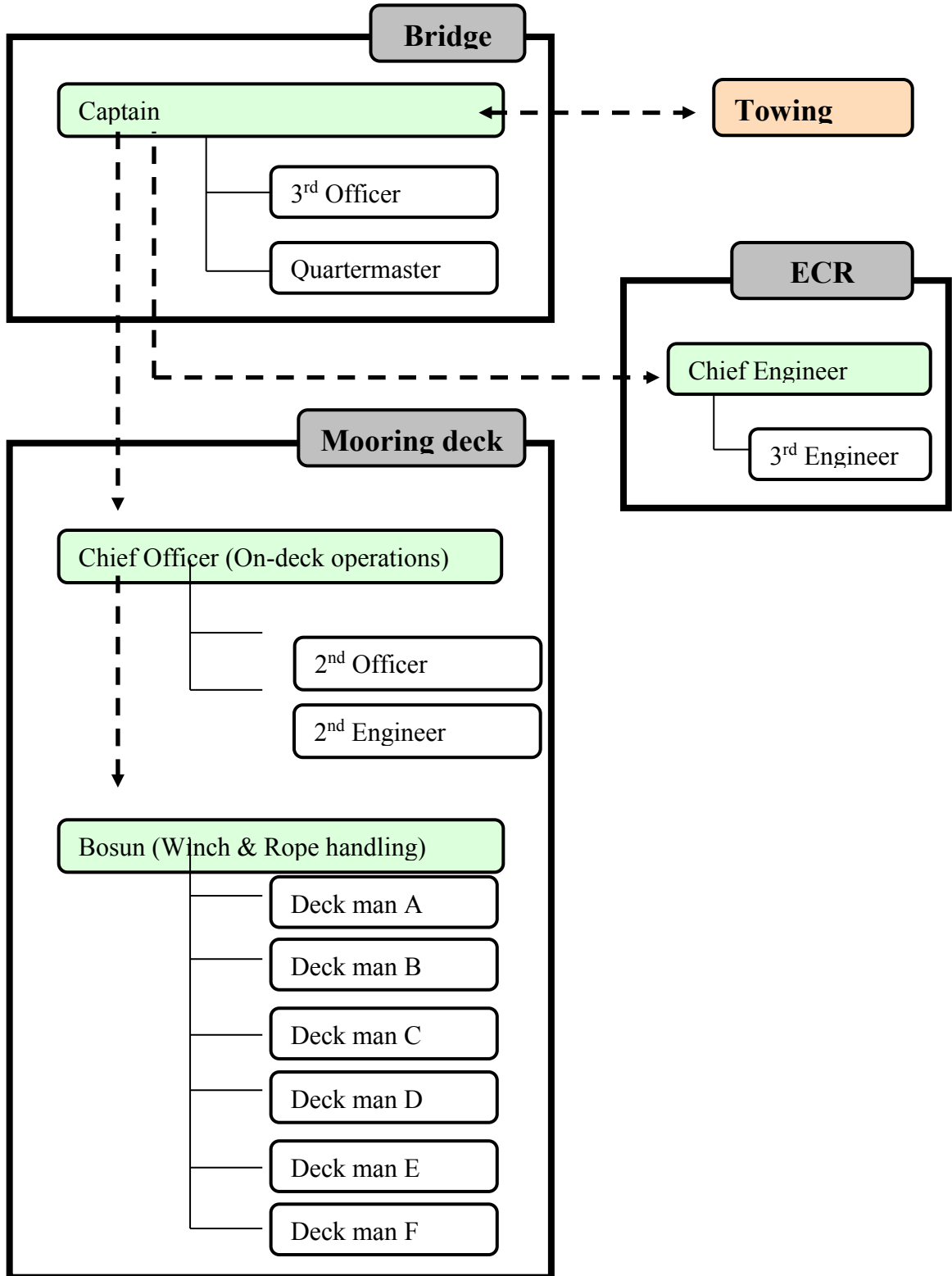

## Appendix A

### Tasks and equipment

No.	Person	Equipment			Task	Position
		Personnel life saving appliance	Portable wireless radio	On-deck tools		
1	<b>Captain</b>		○		Communication with towing ship Overall responsible person	Bridge
2	3rd Officer				Assistant to Captain	
3	Quartermaster				Steering	
4	<b>Chief Officer</b>	○	○		Communication with Bridge, Responsible person on deck	Mooring Deck
5	2nd Officer	○	○		Assistant to Chief Officer	
6	2nd Engineer	○	○			
7	<b>Bosun</b>	○	○		Winch & rope operations	
8	Deck man A	○		○	Winch & rope handling	
9	Deck man B	○		○		
10	Deck man C	○		○		
11	Deck man D	○		○		
12	Deck man E	○		○		
13	Deck man F	○		○		
14	<b>Chief Engineer</b>				Responsible person in engine room	ECR
15	3rd Engineer				Assistant to Chief Engineer	



# Appendix A

## TOWING PATTERNS

### General

This chapter describes typical towing patterns on fore and aft deck.

### Towing from bow

The following figures show the typical arrangements of towing line connection for towing from bow.

#### [Pattern F1]

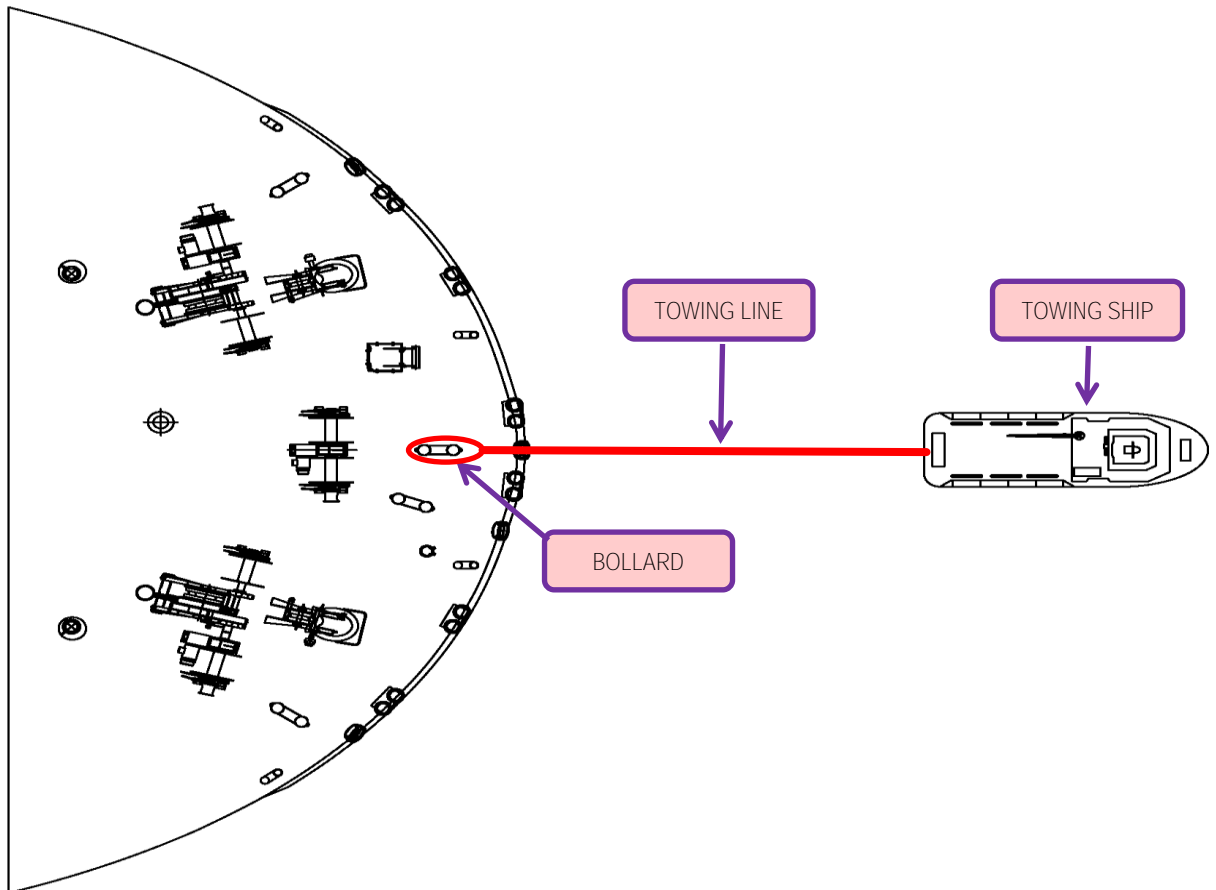

# Appendix A

[Pattern F2]

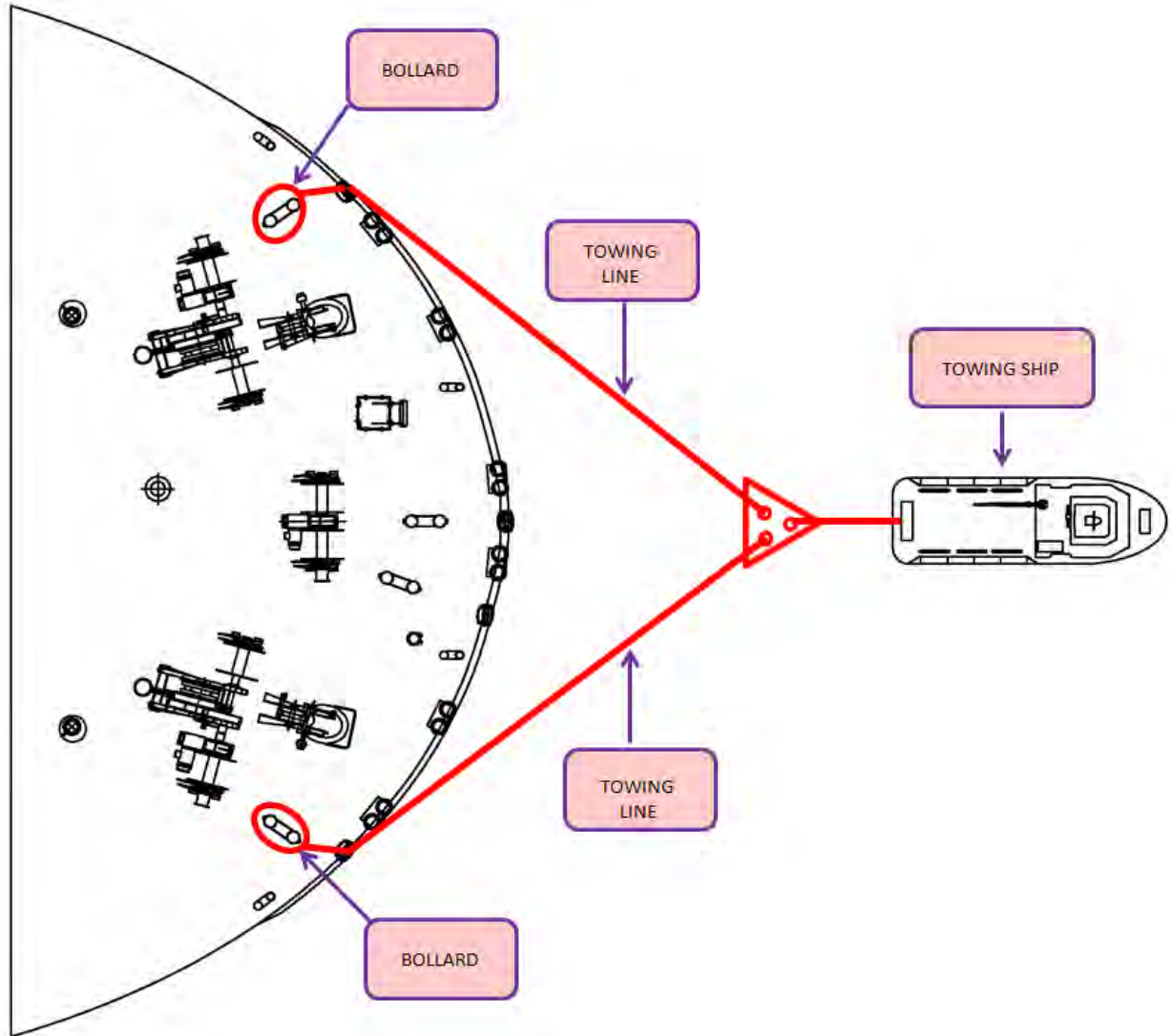

# Appendix A

## [Pattern F3]

Use a chafing chain from chain stopper or Smit bracket (if ETS is fitted).

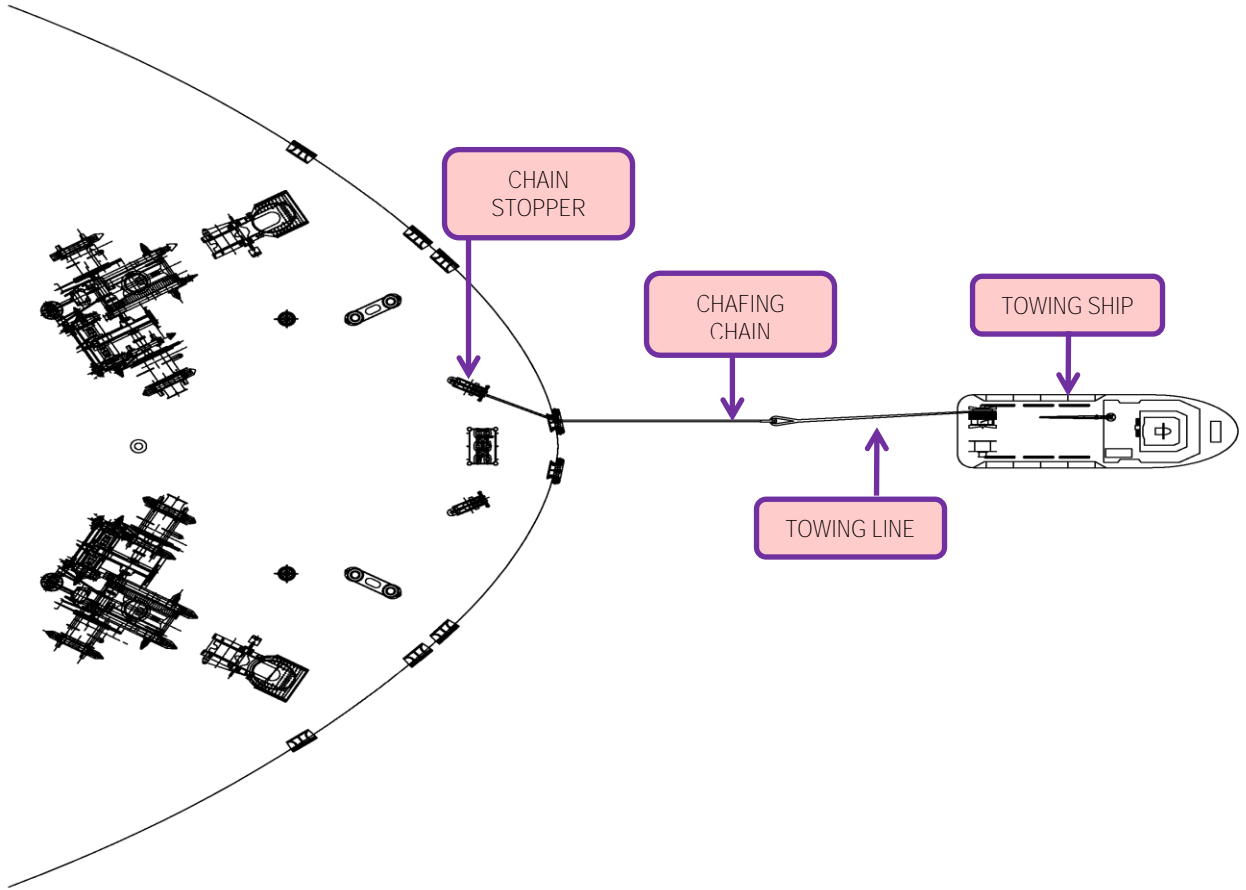

# Appendix A

## Towing from stern

The following figures show the typical arrangements of towing line connection for towing from stern.

### [Pattern A1]

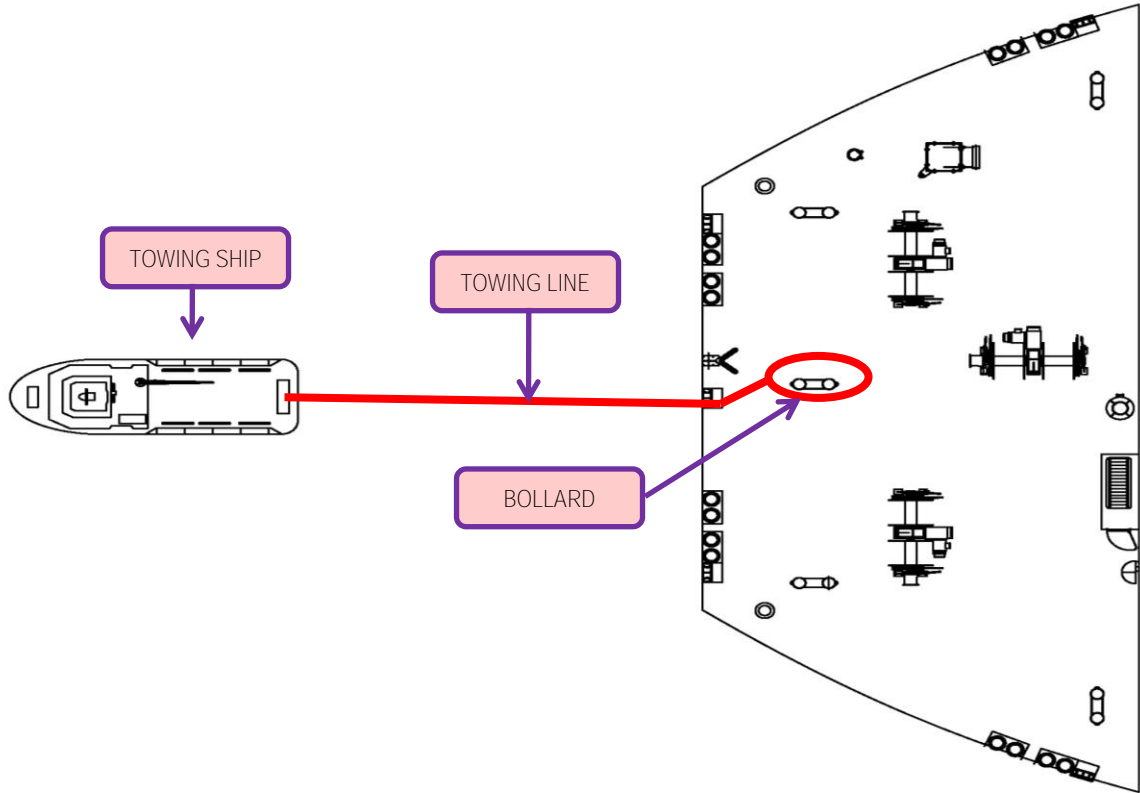

# Appendix A

[Pattern A2]

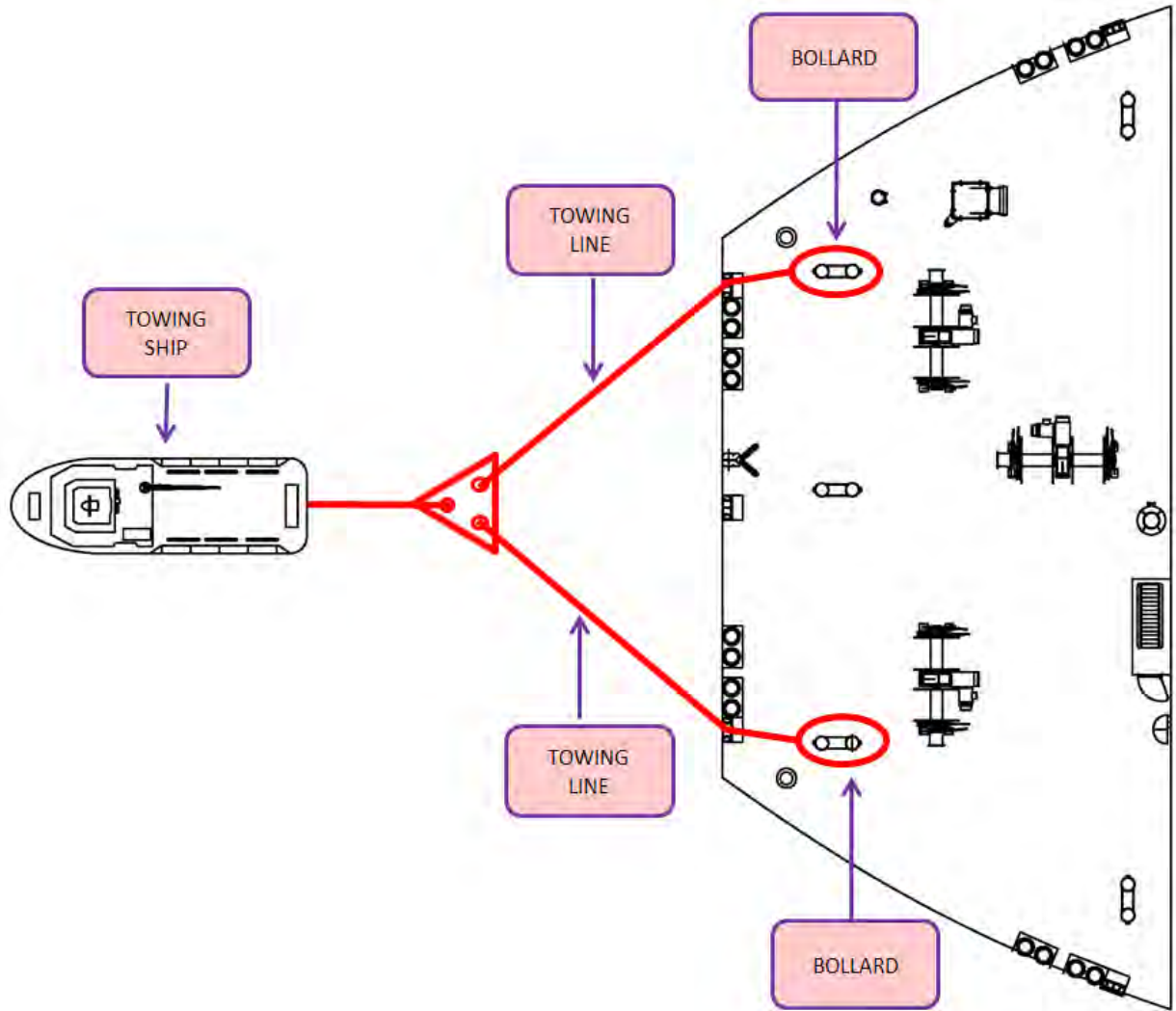

# Appendix A

## [Pattern A3]

Use a storage drum and strong point (If ETS is fitted).

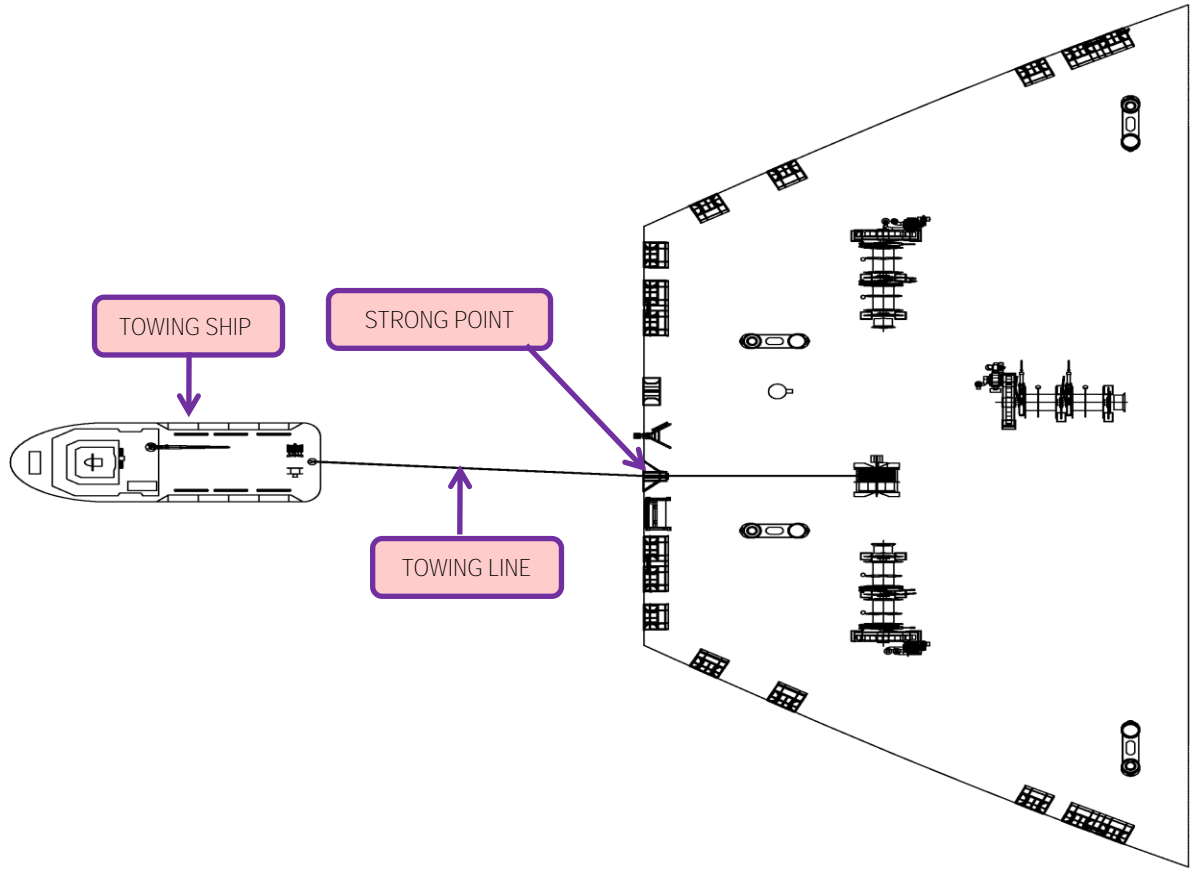

## Appendix A

### DECISION MATRIX

#### Decision matrix for determining towing pattern

The towing pattern should be decided by the ship's master, in consultation with the master of towing ship, by using the following Decision Matrix.

The ship should be towed from the bow as far as possible. If it is not possible to tow from the bow for some reasons such as grounding, collision, etc., towing from the stern may be selected as an alternative.

For determining the towing pattern, the following status and surrounding conditions should be taken into account.

- a) Ship's position;
- b) Weather and sea conditions;
- c) Short-term marine forecast for the area of the incident;
- d) Direction and rate of drift;
- e) Distance and estimated time to any possible grounding location;
- f) Availability of propulsion system; and
- g) Availability of power supply for deck machinery.

#### Decision matrix (if ETS is not fitted)

Condition	Towing pattern		Status
	Bow	Stern	
Imminent and immediate danger, e.g. risk of grounding in less than 1 hour	F1	A1	<ol style="list-style-type: none"> <li>1. The pattern F1 or A1 is to be used provided that the towing force is controlled so as not to exceed the Safe Working Load (SWL) of the deck fittings.</li> <li>2. If the weather is severely bad, the additional towing lines are to be connected between the towed ship and the towing ship.</li> </ol>
The duration of being towed is long	F2	A2	<ol style="list-style-type: none"> <li>1. If possible, the two (2) set of towing lines are to be used.</li> <li>2. If possible, a chain is to be used so that the towing force can be controlled so as not to exceed the Safe Working Load (SWL) of deck fittings.</li> </ol>

#### Decision matrix (if ETS is fitted)

Condition	Towing pattern		Status
	Bow	Stern	
Imminent and immediate danger, e.g. risk of grounding in less than 1 hour	F3	A3	<ol style="list-style-type: none"> <li>1. The pattern A3 is the preferred method in this condition, time of deployment is less than 15 minutes.</li> <li>2. Alternative Pattern F3 if the time allowed is 1 hour.</li> </ol>

## **Appendix A**

### **PROCEDURES FOR CONNECTING TOWING LINES**

#### **General**

This chapter describes the towing patterns of F1, F3, A1, and A3. Similar procedures should be adopted for the other patterns.

The typical procedures are introduced for connecting towing lines in either case of 'on-deck power available case' or not.

Any identified improvement recognized through mariners' experience should be implemented.



## Appendix A

### Towing from bow (Pattern F1 – if on-deck power is available)

#### [Step 1]

Receive the messenger rope from the towing ship.

#### [Step 2]

Pass the messenger rope through the closed chock.

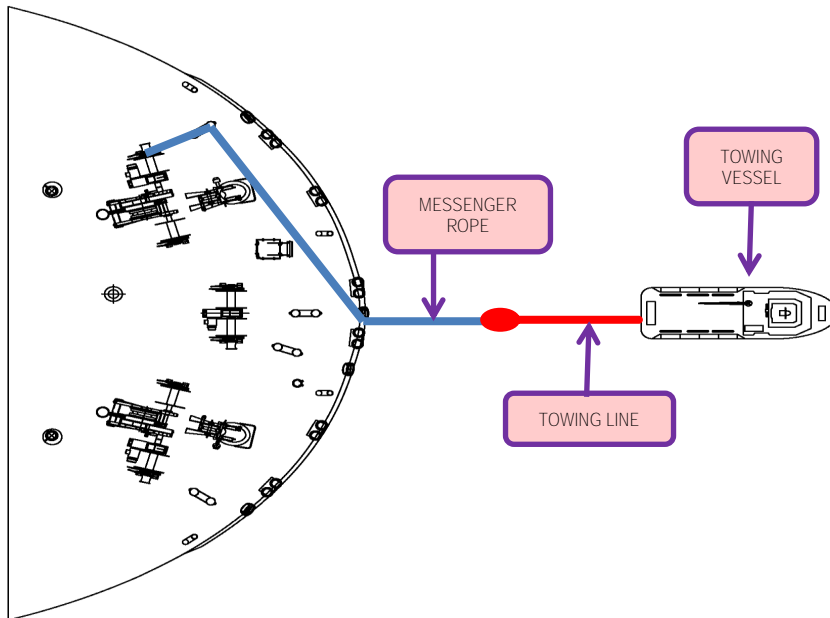

#### [Step 3]

Wind the messenger rope by using warping head until the eye splice of the towing line reaches the bollard.

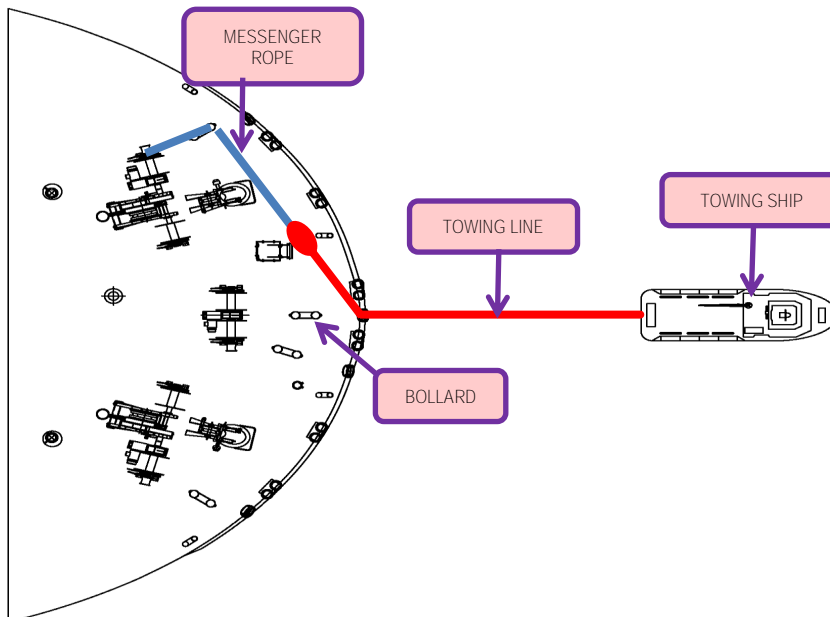

## Appendix A

### [Step 4]

Connect the rope stopper between the towing line and the bollard.

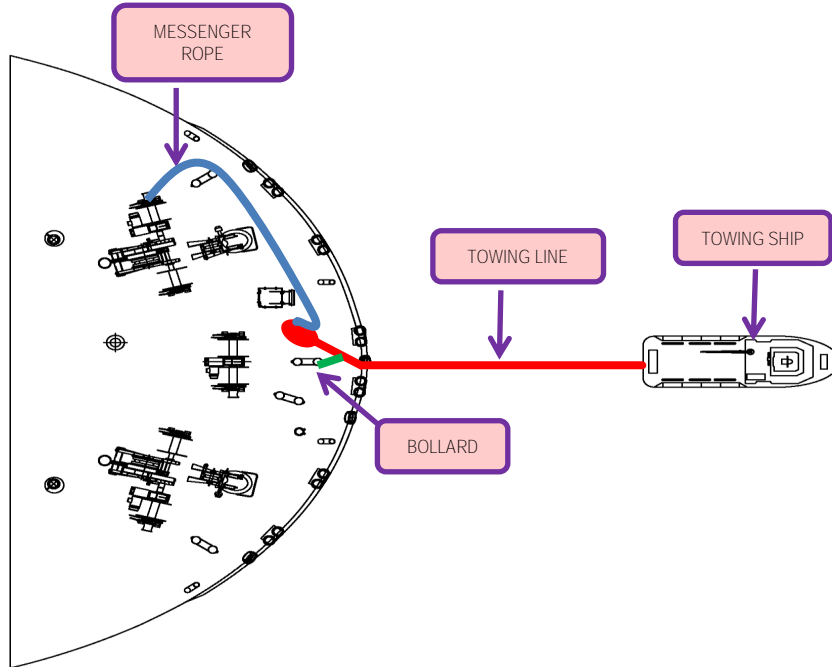

### [Step 5]

Hook the eye splice of the towing line on the bollard.

### [Step 6]

Detach the rope stopper and the messenger rope from the towing line.

### [Step 7]

Start towing the towed ship.

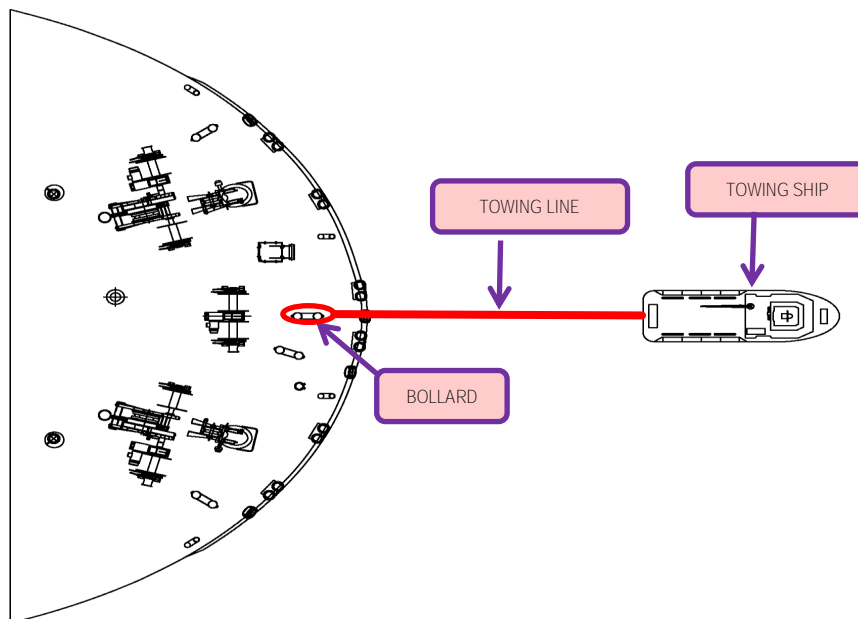

## Appendix A

### Towing from bow (Pattern F1 – if on-deck power is NOT available)

#### [Step 1]

Receive the messenger rope from the towing ship.

#### [Step 2]

Pass the messenger rope through the closed chock, the bollard and the fairlead to the towing ship.

#### [Step 3]

Connect the messenger rope with the towing line on the towing ship.

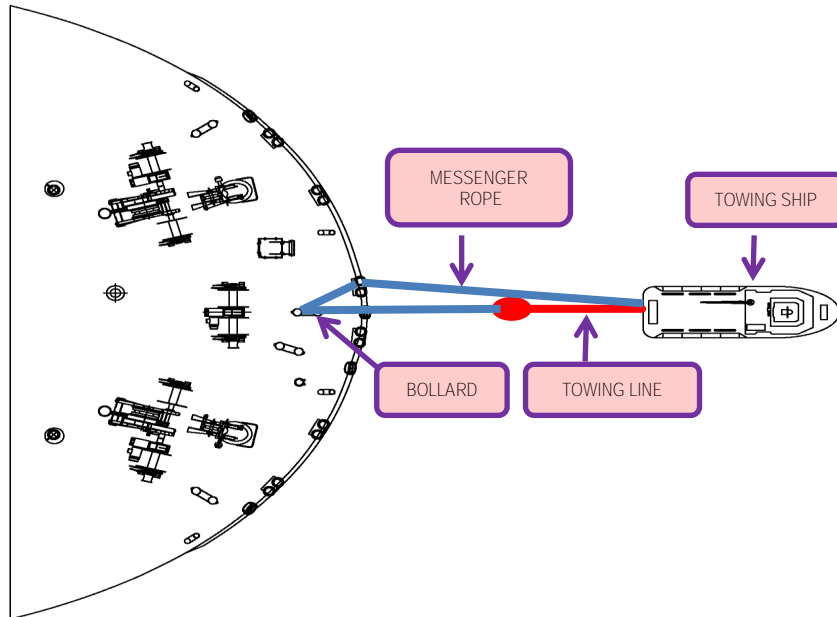

#### [Step 4]

Wind up the messenger rope by using the winch on the towing ship until the eye splice of the towing line reaches the bollard of towed ship.

# Appendix A

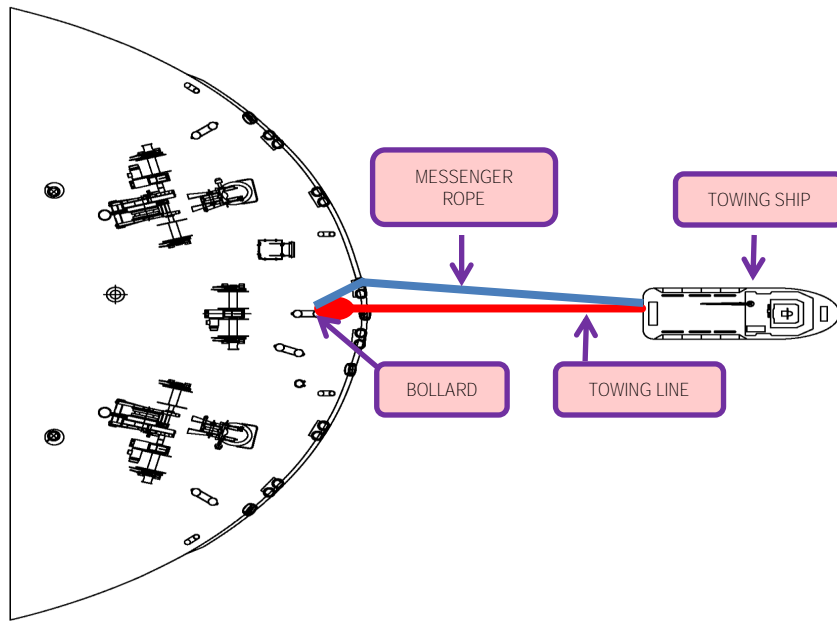

## Appendix A

### [Step 5]

Connect the rope stopper between the towing line and the bollard.

### [Step 6]

Wind off the messenger rope from the mooring winch of towing ship.

### [Step 7]

Hook the eye splice of the towing line on the bollard.

### [Step 8]

Detach the rope stopper and the messenger rope from the towing line.

### [Step 9]

Start towing the towed ship.

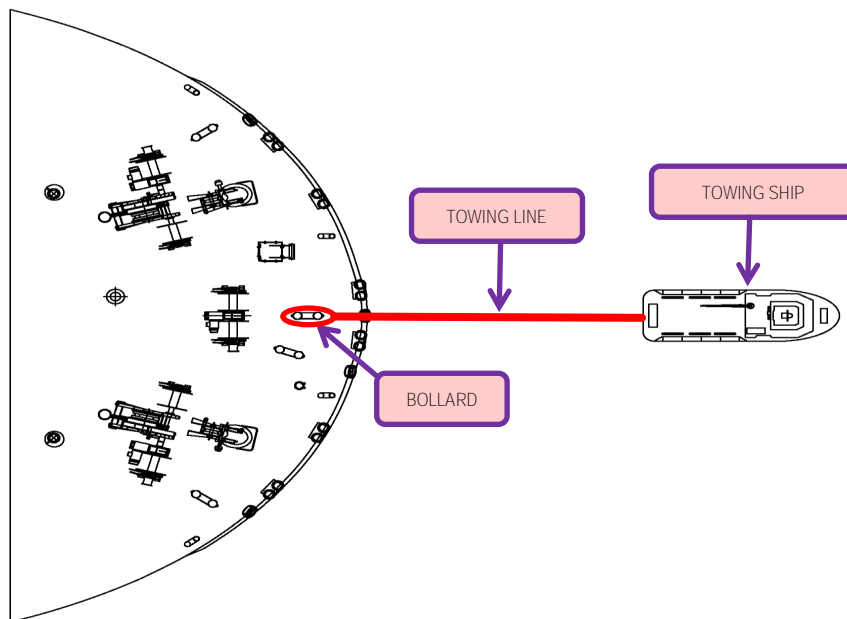

### Towing from stern (Pattern A1)

The procedures introduced in 6.2 or 6.3 are applicable for the towing from stern as well.

## Appendix A

### Towing from bow (Pattern F3)

#### [Step 1]

1. Tie the end of heaving rope(Ⓐ) up to the towed ship.
2. Pass the heaving rope(Ⓐ) through the fairlead (Ⓒ) on the towed ship and throw the other end of heaving rope(Ⓐ) to the towing ship.

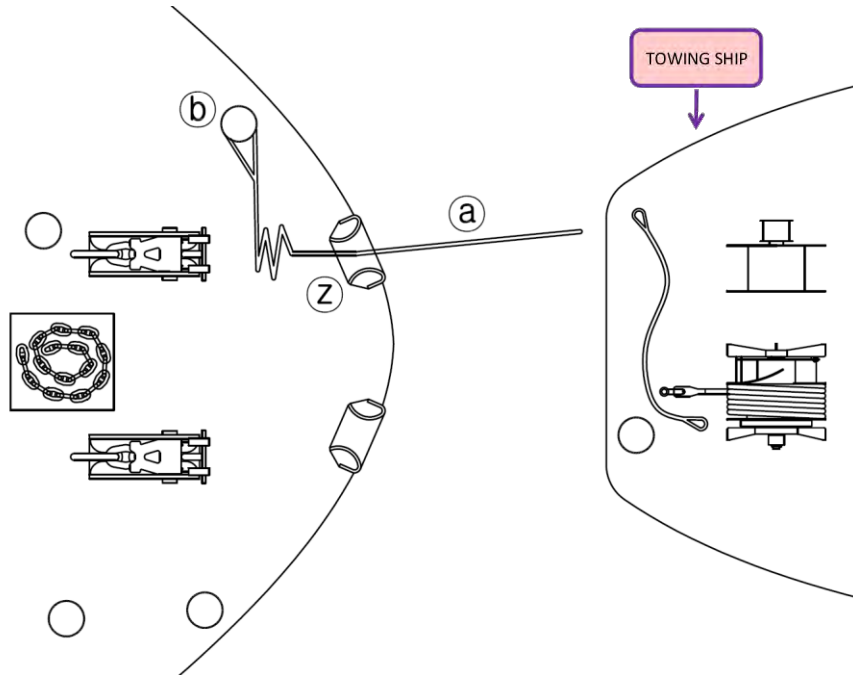

#### [Step 2]

1. Pick up the heaving rope(Ⓐ) at the towing ship.
2. Connect the heaving rope(Ⓐ) with the messenger rope(Ⓔ) and the towing line(Ⓛ).

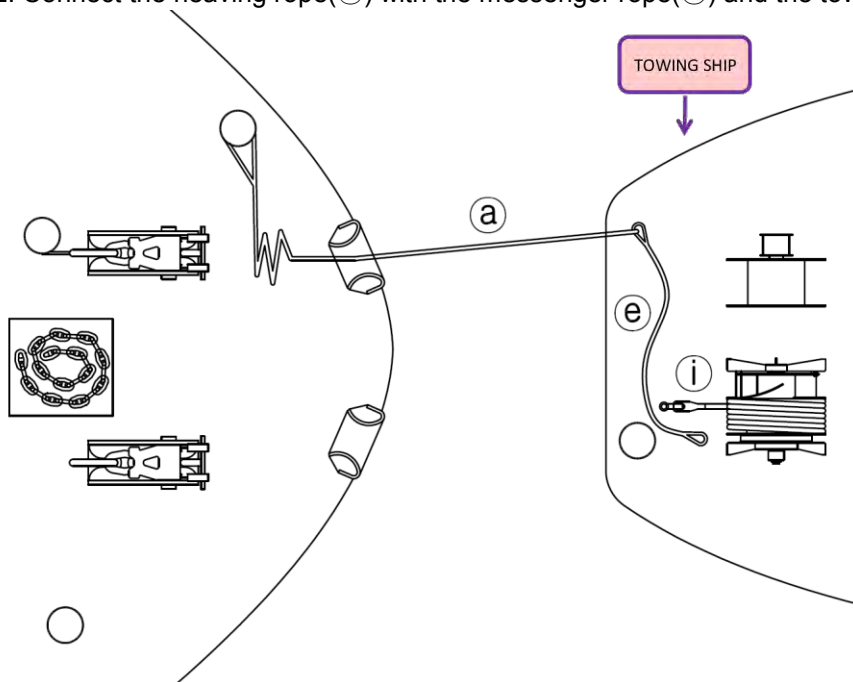

## Appendix A

### [Step 3]

1. Pull up the messenger rope (e) to the towed ship up to the messenger rope and pass it through the opening of the dog of chain stopper (f).
2. Return the messenger rope (e) to the towing ship by using bollard (b) and/or stand roller (b) and shipside fairlead.
3. Wind up the messenger rope by using the winch on the towing ship so that the end of towing line (i) comes to the chain stopper on the towed ship.

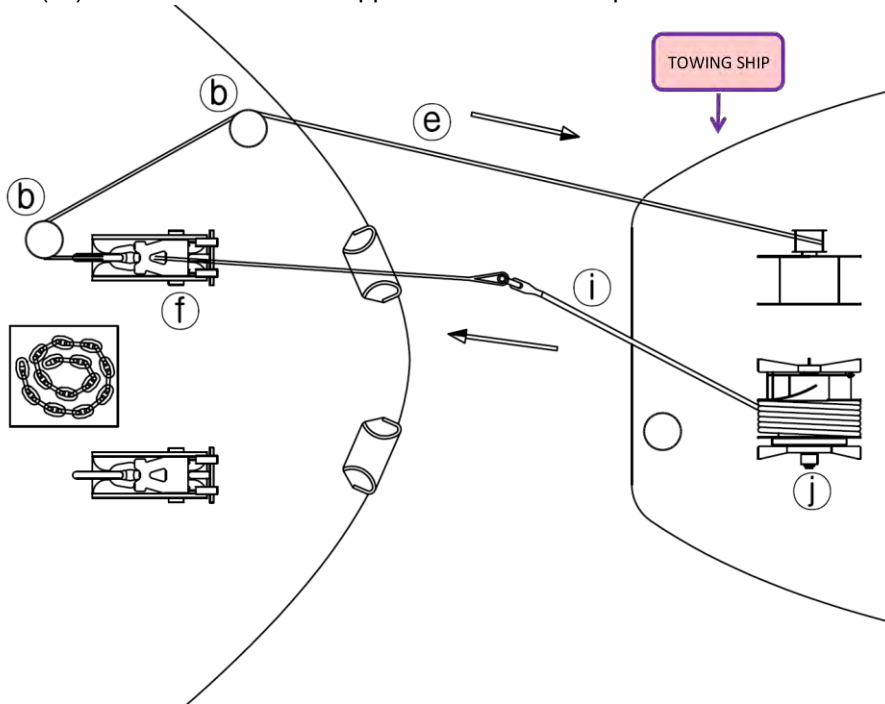

### [Step 4]

1. Tie up the towing line (i) to bollard (b) on the towed ship by using the seizing rope.
2. Connect the messenger rope (e) to the end of chafing chain (c) on the towed ship.

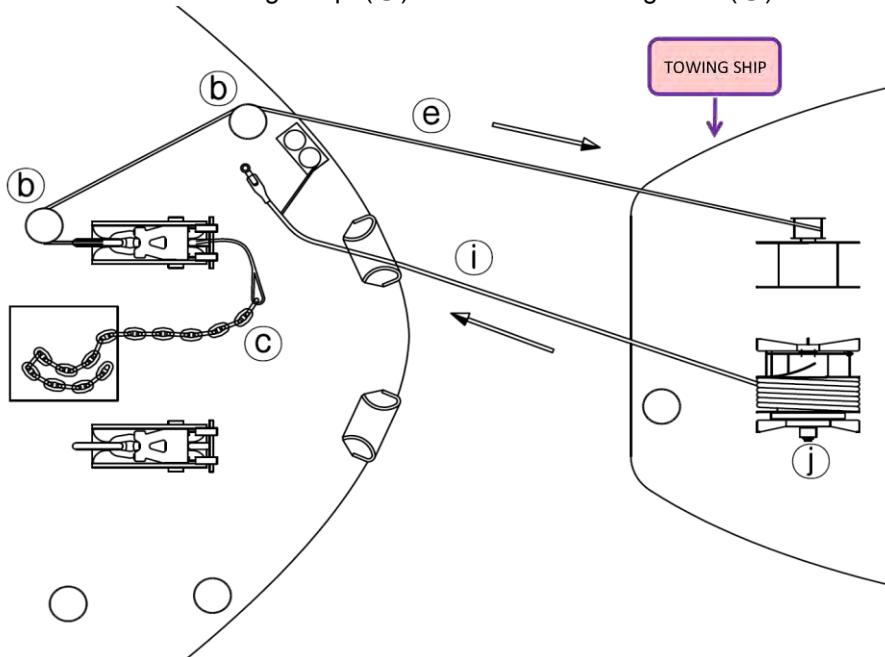

## Appendix A

### [Step 5]

1. Connect the towing line (i) to the end of chafing chain (c).
2. Wind up the messenger rope (e) by using the winch (k) on the towing ship in order to engage the chafing chain to the chain stopper.

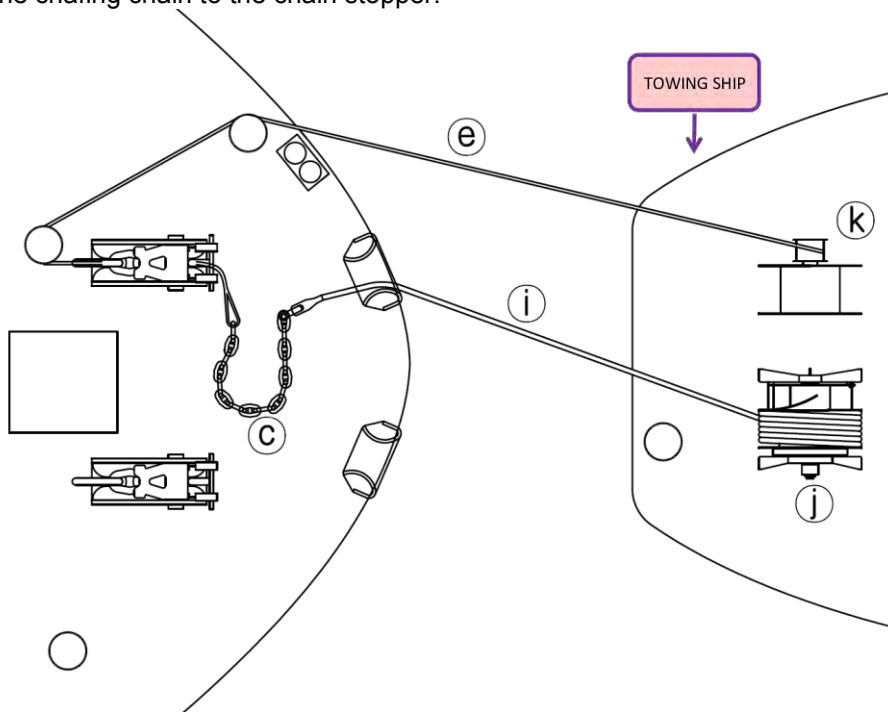

### [Step 6]

1. Connect the end of chafing chain (c) to the chain stopper (f) and engage the dog of chain stopper (j).
2. Drive the towing ship forward to start towing.



# Appendix A

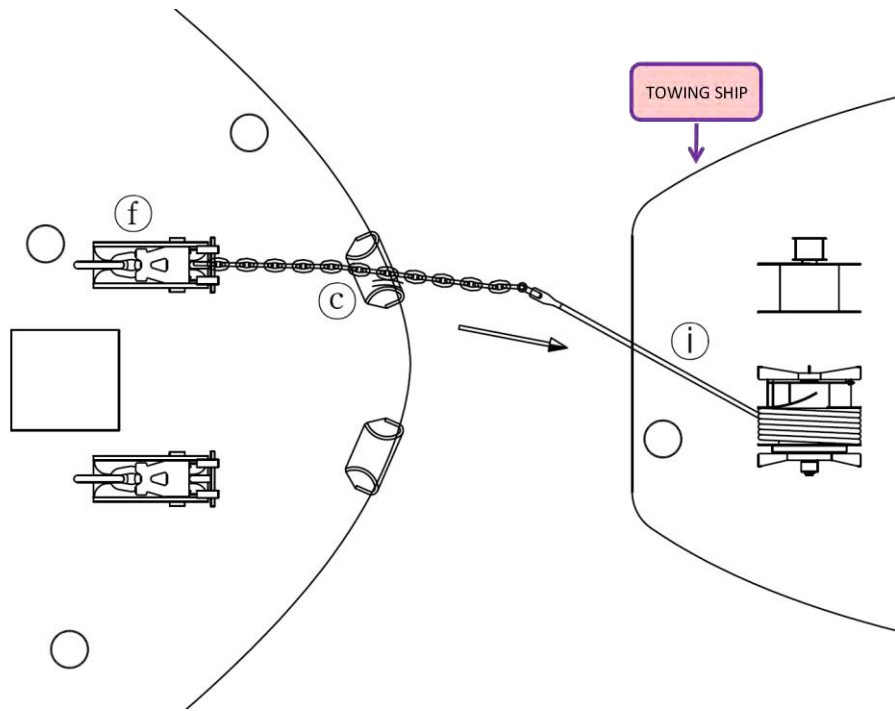

# Appendix A

## Towing from stern (Pattern A3)

### [Step 1]

1. Open the pick-up rope box (b) on the towed ship so as drop the messenger rope (f) and self-igniting buoy (a) into the sea.

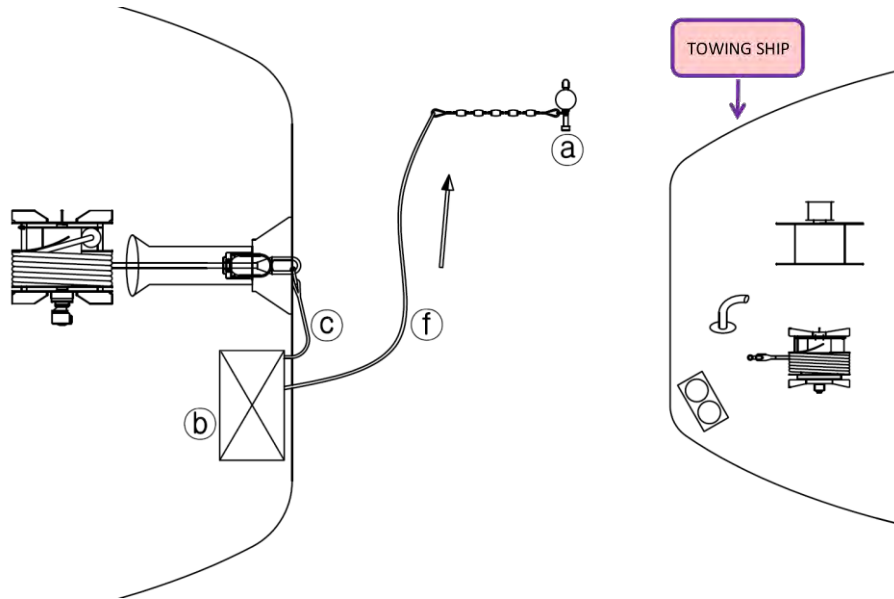

### [Step 2]

1. Pick up the messenger rope (f) and wind the messenger rope (f) by using the winch on the towing ship.

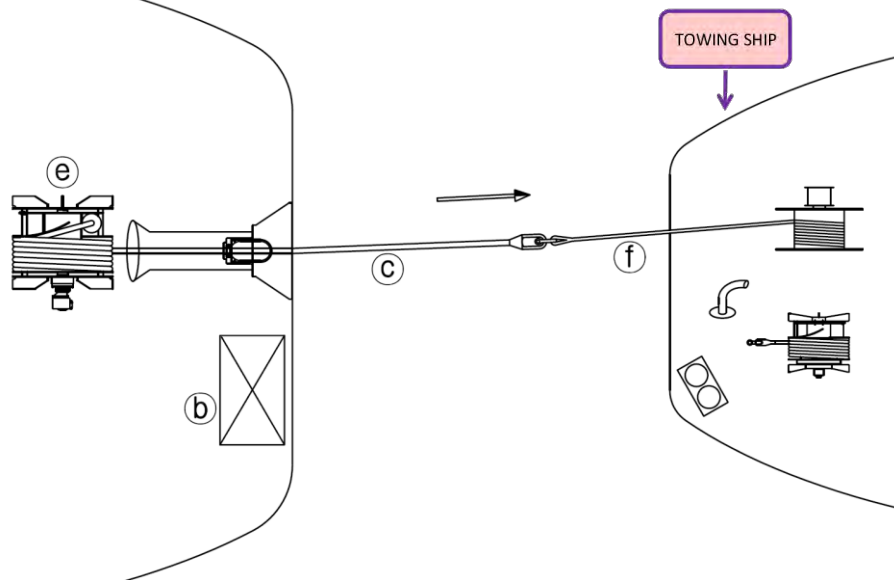

## Appendix A

### [Step 3]

1. Wind the messenger rope and the towing line(c) till the stopper(g) touches the strong point(h) of the towed ship.
2. Tie up the towing line(c) to the bollard on the towing ship by using the seizing rope(i).
3. Connect the end of towing line(c) to the strong point on the towing ship.

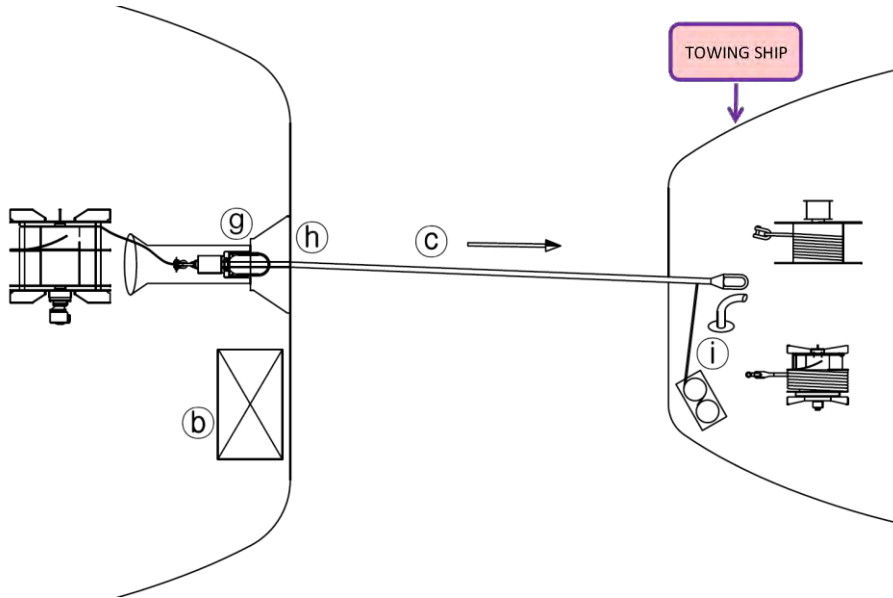

### [Step 4]

1. Drive the towing ship forward to start towing.

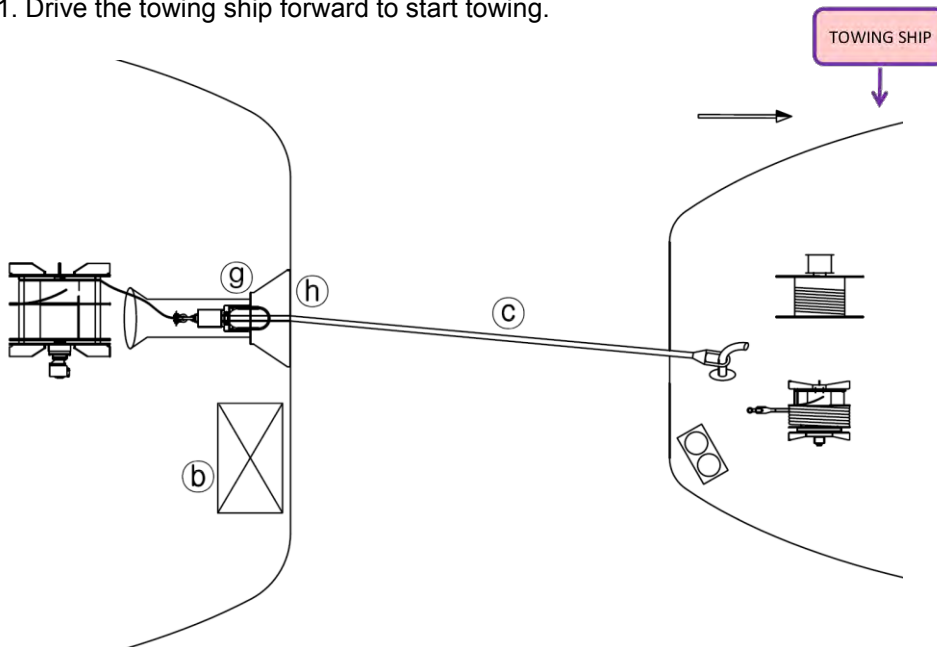

## Appendix A

### CURRENT STATUS

#### General

No.	Item	Status	
1	Current time	Date/Month/Year	Time
2	Current position		
3	Cause of towing	Describe the cause :	
4	Weather condition		
5	Weather forecast		
6	Wave height		
7	Ship's draft	Fore :	Aft :
8	Displacement		
9	Wind velocity and direction	Velocity [knots]	Direction
10	Drifting speed and direction	Speed [knots]	Direction

## Appendix A

### Damage and seaworthiness

No.	Item	Status	
1	Flooding or outflow?	<input type="checkbox"/> Yes <input type="checkbox"/> No	Describe the status :
2	Imminent danger? (e.g. grounding)	<input type="checkbox"/> Yes <input type="checkbox"/> No	Describe the danger :
3	Cargo loaded?	<input type="checkbox"/> Yes <input type="checkbox"/> No	Describe the type of cargo :
4	Is the main engine available?	<input type="checkbox"/> Yes <input type="checkbox"/> No	Describe the status of M/E :
5	Is the trim controllable?	<input type="checkbox"/> Yes <input type="checkbox"/> No	
6	Can the ship be towed from the bow?	<input type="checkbox"/> Yes <input type="checkbox"/> No	Describe the status :
7	Can the ship be towed from the stern?	<input type="checkbox"/> Yes <input type="checkbox"/> No	Describe the status :
8	Is there heeling?	<input type="checkbox"/> Yes <input type="checkbox"/> No	
9	Oil leakage? If any, give status	<input type="checkbox"/> Yes <input type="checkbox"/> No	Describe the status :

## Appendix A

### Steering and propulsion

No.	Item	Status	
1	Is the rudder operable?	<input type="checkbox"/> Yes <input type="checkbox"/> No	Describe the status :
2	If the rudder is damaged, what is the current rudder angle and is it possible to return to amidships?	<input type="checkbox"/> Yes <input type="checkbox"/> No	Describe the status :
3	Can the propeller shaft be prevented from turning?	<input type="checkbox"/> Yes <input type="checkbox"/> No	Describe the status :
4	Can the mooring equipment on deck be used for tow line connection?	<input type="checkbox"/> Yes <input type="checkbox"/> No	Describe the status :

### Power system

No.	Item	Status	
1	Is the power on board available?	<input type="checkbox"/> Yes <input type="checkbox"/> No	Describe the status :
2	Can the deck lighting be used for the towing line connection?	<input type="checkbox"/> Yes <input type="checkbox"/> No	Describe the status :
3	Can the mooring winch be used for winding the towing line?	<input type="checkbox"/> Yes <input type="checkbox"/> No	Describe the status :
4	Can the towing side/stern lights be used?	<input type="checkbox"/> Yes <input type="checkbox"/> No	

## Appendix A

### [Postscript] Steering Committee

<b>Responsibility</b>	<b>Name</b>	<b>Company</b>
Manager	J. R. Oh	Samsung Heavy Industries Co., Ltd.
Member	H. S. Baek	Daewoo Shipbuilding & Marine Engineering
Member	J. H. Kang	Daewoo Shipbuilding & Marine Engineering
Member	S. Y. Hong	Hyundai Heavy Industries Co., Ltd.
Member	Y. H. Yang	Hanjin Heavy Industries & Construction Co., Ltd.
Member	T. J. Park	Hyundai Samho Heavy Industries Co., Ltd.
Member	J. H. Cha	Korea Marine Equipment Research Institute
Member	S. H. Byun	Korean Register of Shipping
Member	B. G. Kwon	Korea Shipbuilders' Association
Member	H. T. Kim	Korea Ocean Research & Development Institute

# Appendix A

<b>Emergency Ship Tow - Vessel Information Request</b>			
This form is to be used to obtain information about the vessel in need of assistance.			
Name of person filling out this form			
Date	Time		
Name of Vessel	Name of Master		
Call Sign	Vessel Flag		
Vessel Cargo (if empty record no cargo)			
Position of Casualty			
Nature of Casualty			
Last Port	Destination		
Freeboard			
Is the Casualty in immediate danger? <input type="checkbox"/> Yes <input type="checkbox"/> Describe:			
Is the vessel capable of transferring ballast? <input type="checkbox"/> Yes <input type="checkbox"/> No			
Can the vessel safely be taken in tow? <input type="checkbox"/> Yes <input type="checkbox"/> No			
Was the USCG notified? <input type="checkbox"/> Yes <input type="checkbox"/> No			
Is there a pollution risk? <input type="checkbox"/> Yes <input type="checkbox"/> No Describe:			
Name of person requesting assistance:			
Organization they represent:			
Phone #	Mobile/Cell #		
Email address	Fax #		
On scene weather conditions			
Set and Drift			
Vessel particulars:	Vessel Length	Vessel Beam	
	Draft Fwd	Draft Aft	
Foc'sol deck height above the water			
Communications	VHF Channel # 1	VHF Channel # 2	
	SSB Frequency	Inmarsat #	
	Ship Mobile Phone	Ship Fax	
	Communication Schedule		
Is the vessel equipped with an emergency towing system? <input type="checkbox"/> Yes <input type="checkbox"/> No			
Is there a towing arrangement on the bow and or stern of the vessel? <input type="checkbox"/> Bow <input type="checkbox"/> Stern <input type="checkbox"/> Both			
If yes, what type & manufacturer?			
Is there a towing strong point? <input type="checkbox"/> Yes <input type="checkbox"/> No If yes what type?			
Does the ship have power to deck equipment? <input type="checkbox"/> Yes <input type="checkbox"/> No			
Is the ships steering operational? <input type="checkbox"/> Yes <input type="checkbox"/> No Is there a need to secure the shaft? <input type="checkbox"/> Yes <input type="checkbox"/> No			
If the steering is not operational what is the rudder position?			
Can the rudder be secured in the amidships position? <input type="checkbox"/> Yes <input type="checkbox"/> No			
Will the ships crew be able to steer the ship once under tow? <input type="checkbox"/> Yes <input type="checkbox"/> No			
Is the ships windless operational? <input type="checkbox"/> Yes <input type="checkbox"/> No			
Does the ship have a tow plan? <input type="checkbox"/> Yes <input type="checkbox"/> No Can you obtain a copy? <input type="checkbox"/> Yes <input type="checkbox"/> No			
If no tow plan, can photographs of the ships bow and stern decks be obtained to locate the bits , chocks another deck fittings? <input type="checkbox"/> Yes <input type="checkbox"/> No			
Is the crew capable of rigging the tow gear <input type="checkbox"/> Yes <input type="checkbox"/> No			
Are there English speaking officers onboard <input type="checkbox"/> Yes <input type="checkbox"/> No			
Other (fill in)			
Other (fill in)			
<b>Notes</b>			



# Appendix A

Appendix G		Emergency Ship Tow Preparation & Requirements Checklist	
The form is designed to assist the Master/mate in preparing a vessel for rescue or salvage towing by providing a general checklist for items necessary for rescue towing. It may be amended as needed.			
Towing Vessel			
Date			
Master			
Fuel Onboard			
Lube Onboard			
Name of Towed Vessel			
Item #	Required Items (recorded variances in note section below)	Yes	No
1	Appropriate charts and publications	<input type="checkbox"/>	<input type="checkbox"/>
2	Weather reports and routing	<input type="checkbox"/>	<input type="checkbox"/>
3	Voyage Plan	<input type="checkbox"/>	<input type="checkbox"/>
4	Voyage Orders	<input type="checkbox"/>	<input type="checkbox"/>
5	Tow Plan	<input type="checkbox"/>	<input type="checkbox"/>
6	Ports of refuge on tow route	<input type="checkbox"/>	<input type="checkbox"/>
7	Stores and supplies	<input type="checkbox"/>	<input type="checkbox"/>
8	Properly qualified crew complement with documentation appropriate for the voyage	<input type="checkbox"/>	<input type="checkbox"/>
9	Miscellaneous Poly and Dacron line from 3/8" to 5/8" diameter	<input type="checkbox"/>	<input type="checkbox"/>
10	Messenger lines with adequate spares ( sizes from 1 1/2" spectra line to 7 & 8 poly eight or 12 strand preferable, RP-12 or similar line)	<input type="checkbox"/>	<input type="checkbox"/>
11	Line Gun (with spare cartridges, shot line and rods)- if another type line throwing device such as a Paine Wessex is carried, then ensure sufficient spares on board to allow more than one shot to be made.	<input type="checkbox"/>	<input type="checkbox"/>
12	1" and 1 1/2" Wire straps and stoppers from 3/6"/12' eye and eye with spares	<input type="checkbox"/>	<input type="checkbox"/>
13	3/8" and 1/2" chain with connecting links available for chain chokers and stoppers (grade 40 or 70 preferred with appropriate strength connecting links)	<input type="checkbox"/>	<input type="checkbox"/>
14	Assorted line straps and stoppers	<input type="checkbox"/>	<input type="checkbox"/>
15	Heavy duty Snatch block	<input type="checkbox"/>	<input type="checkbox"/>
16	Cargo hook with safety latch -Crosby S-320N Alloy 22 ton	<input type="checkbox"/>	<input type="checkbox"/>
17	Carpenters clamp sized for the tugs tow wire	<input type="checkbox"/>	<input type="checkbox"/>
18	Sufficient Towing shackles and spares, cotter keys, bolts	<input type="checkbox"/>	<input type="checkbox"/>
19	Cutting torch with tips, tip cleaner, striker, working gauges & Oxygen / Acetylene bottles full	<input type="checkbox"/>	<input type="checkbox"/>
20	Surge gear onboard (2) full shots and (2) 1/2 shots of 3" stud-link surge chain.	<input type="checkbox"/>	<input type="checkbox"/>
21	Two galvanized hard wire rescue tow pennants 2 1/4" x 90ft eye on one end, towing thimble on the other.	<input type="checkbox"/>	<input type="checkbox"/>
22	Miscellaneous working shackles for straps, and messenger lines	<input type="checkbox"/>	<input type="checkbox"/>
23	150 ft x 1 1/2" Swede wire ( Can substitute Plasma line)	<input type="checkbox"/>	<input type="checkbox"/>
24	Spare Portable VHF radios (for direct communications with ship deck crew in case ship does not have enough)	<input type="checkbox"/>	<input type="checkbox"/>
25	Surge gear onboard (2) full shots and (2) 1/2 shots of 3" stud-link surge chain.	<input type="checkbox"/>	<input type="checkbox"/>
26	Appropriate PPE for deck crew?	<input type="checkbox"/>	<input type="checkbox"/>
27	Emergency Ship Towing System-ESTS (if available in the region- instructions for the use of the package can be found on the MOD in the Manuals section).	<input type="checkbox"/>	<input type="checkbox"/>
28	Other (write in)	<input type="checkbox"/>	<input type="checkbox"/>
29	Other (write in)	<input type="checkbox"/>	<input type="checkbox"/>
30	Other (write in)	<input type="checkbox"/>	<input type="checkbox"/>
Notes			

e.

## **Appendix B**

### **HARBOR SAFETY COMMITTEE OF THE SAN FRANCISCO BAY REGION INCLUDING THE PORTS OF SACRAMENTO AND STOCKTON BYLAWS**

<http://www.sfm.org/support/hsc/ByLaws.pdf>

#### **Article I: Name**

Section 1. The Harbor Safety Committee of the San Francisco, San Pablo and Suisun Bays, including the Ports of Sacramento and Stockton (hereinafter referred to as the Committee).

#### **Article II: Purpose**

Section 1. The Committee is established pursuant to Section 8670.23 of the Government Code and Title 14, California Code of Regulations, Sections 800-802; and is responsible for planning for the safe navigation and operation of tank ships, tank barges, and other vessels within the harbor, and making recommendations to the Administrator of the Office of Spill Prevention and Response (OSPR), hereinafter referred to as the Administrator.

#### **Article III: Membership**

Section 1. Membership Categories

- a. Members shall be selected from local representatives of organizations or companies in the San Francisco Bay Area region (including the Ports of Sacramento and Stockton) whenever possible.
- b. The Committee shall consist of members appointed by the Administrator as follows:
  1. Four designees representing Port authorities: One representative shall be selected from the Port of San Francisco and one from the Port of Oakland. The other two representatives shall be selected from any two of the remaining ports: Richmond, Redwood City, Benicia, Stockton or Sacramento;
  2. One representative of tank ship operators, and one representative of either a tank ship operator or a marine oil terminal operator;
  3. One designee of the San Francisco Bar Pilots Association;

## Appendix B

4. Two representatives of dry cargo vessel operators;
  5. One representative of commercial fishing;
  6. One representative of pleasure boat operators;
  7. One representative of a recognized nonprofit environmental organization that has as a purpose the protection of marine resources;
  8. One designee of the San Francisco Bay Conservation and Development Commission;
  9. One representative from a recognized labor organization involved with waterborne operations of vessels;
  10. One representative of tug operators and one representative of tank barge operators, neither of whom shall also be engaged in the business of operating either tank ships or dry cargo vessels.
  11. One designee from each of the following: Captain of the Port from the U.S. Coast Guard; U.S. Army Corps of Engineers, U.S. National Oceanic and Atmospheric Administration (NOAA), and the U.S. Navy, to the extent that each consents to participate on the Committee as a non appointed member.
- c. Appointees filling membership categories identified in items b1 through b10, above, are specified as appointed members.

### Section 2. Membership Qualifications

The members appointed from the categories listed in Section 1b (2), (3), (4), and (10) above shall have navigational expertise. An individual is considered to have navigational expertise if the individual meets any of the following conditions:

- a. Has held or is presently holding a Coast Guard Merchant Marine Deck Officer's license;
- b. Has held or is presently holding a position on a commercial vessel that includes navigational responsibility;
- c. Has held or is presently holding a shore side position with direct operational control of vessels;
- d. Has held or is currently holding a position having responsibilities relating to the safe navigation of vessels.

### Section 3. At-Large Members

## Appendix B

The Harbor Safety Committee may petition the Administrator to request up to five at-large membership categories that are needed to conduct the Harbor Safety Committee's business and which reflect the make-up of the local maritime community. One at-large member shall represent ferry operators who shall have navigational expertise as defined in Section 2, above, and who is specified to be an appointed member consistent with Section 1c, above. The Committee may also petition the Administrator for the removal of any at-large membership category. The approval of such petitions shall be at the sole discretion of the Administrator.

### Section 4. Term of Membership for Appointed Members and their Alternates

- a. A member shall be appointed for a three-year term.
- b. A member's appointment shall be terminated as a result of any of the following circumstances:
  1. The member retires from, or otherwise leaves employment under which he was appointed. Members who leave their employer may, if qualified under their new employment, apply for the seat they vacated or, if qualified, apply for another Committee seat that becomes vacant.
  2. The member undergoes a change in work responsibilities, which alters the constituency that he represents, or alters his qualifications for the position.
  3. The member voluntarily resigns for any reason.
  4. A member is removed by the Administrator for any reason under Section 7, below.
- c. A member impacted by any of the conditions identified in items 1-4 above is expected to submit his resignation to the Chair (with a copy to the Administrator) within five working days.
- d. Any incumbent completing his three-year term may re-apply.
- e. Except as noted in Section 5c, below, an alternate's term expires when the primary member leaves service for any reason.

### Section 5. Alternates for Appointed Members

- a. The alternate representative shall be appointed and sworn by the Administrator in a manner similar to the primary member. Only one alternate shall be appointed for each primary member, and only the appointed alternate is accorded proxy powers. The alternate shall be selected from the same membership category as the primary member, and shall meet the same qualifications. The appointed alternate may vote, participate in, or take any other action on behalf of the primary member consistent with the Committee's bylaws and any applicable statutory or regulatory provisions.
- b. An alternate may vote only in the absence of the primary member.
- c. When a primary member resigns or is removed, his alternate may continue to serve until such time as the new primary member is appointed and sworn in.

## Appendix B

- d. The Committee offers the Administrator the following guidelines for appointing alternates:
  1. When possible, the primary member should be allowed to recommend his alternate;
  2. If there is more than one applicant for a position, the primary member and Administrator should consider the other applicants when selecting alternates. The Committee requests the Administrator consider diversity of organizations within each membership category when selecting alternates.

### Section 6. Attendance of Appointed Members

- a. Attendance of scheduled Committee meetings is expected. The standard of attendance is determined as follows:
  1. For each appointed membership category team consisting of a primary member and alternate, meeting either condition (a) or (b) is considered to be not meeting the standard of attendance:
    - (a) The primary member of the team missing four consecutive meetings, or a total of six meetings in a calendar year.
    - (b) The team missing three consecutive meetings, or a total of four meetings in a calendar year.
  2. For a primary member with no alternate, meeting condition (a) is considered to be not meeting the standard of attendance:
    - (a) Missing four consecutive meetings, or a total of six meetings in a calendar year.
- b. The Committee Chair shall review the meeting attendance records on a regular basis and shall inquire about members and teams with excessive absences.
- c. The Chair may make an exception to the attendance standards for a member experiencing extenuating circumstances.

### Section 7. Appointed Member Removal

- a. Circumstances may arise which require that a Committee member voluntarily resign or be removed from their position. Such events include:
  1. Failing to meet the attendance standards, as set in Section 6,
  2. Falsifying application materials,

## **Appendix B**

3. The member's term ending prematurely due to meeting one of the conditions described in Article III, Section 4, items b1 and b2.

b. A member who demonstrates any of the three criteria listed above is expected to voluntarily tender his written resignation to the Chair (with a copy to the Administrator) within five working days of being informed of this condition. If the expected resignation is not forthcoming, the Chair shall privately contact the member, explain which bylaw(s) has been violated, and seek the member's written resignation. If the request is not honored within ten working days, the Chair shall write to the member (with a copy to the Administrator), explaining which bylaw(s) has been violated and, again, request a written resignation. If the resignation is not offered within 15 working days the Chair shall notify the Administrator in writing (with a copy to the member) of the situation, identify which bylaw(s) has been violated, and seek the Administrator's assistance in removing the recalcitrant member.

c. The Chair shall announce at the next full meeting the resignation or removal of any member.

### **Article IV: Officers**

Section 1. The Administrator shall appoint a Chairperson for the Committee from the membership specified in Article III.

Section 2. The Administrator shall appoint a Vice-chairperson for the Committee from the membership specified in Article III, from a membership category other than that of the Chairperson.

Section 3. An Executive Secretary (Secretariat) for the Committee shall be contracted by the Administrator. The Secretariat shall serve as the Administrative staff to the Committee.

### **Article V: Subcommittees and Work Groups**

Section 1. The Committee may establish Subcommittees and Work Groups, as it deems necessary. Meetings shall be duly noticed and open to the public in accordance with Article VII to receive maximum participation.

Section 2. The Chair of the Harbor Safety Committee shall appoint the chairperson of Subcommittees and Work Groups. The Chair may appoint Subcommittee members.

## **Appendix B**

Section 3. Subcommittees should be composed of an uneven number of voting Committee members with no fewer than three people on a subcommittee. Vote by the majority of the subcommittee members present shall be necessary to pass a recommendation of the subcommittee. If a majority of Committee members are voting at a subcommittee meeting, that meeting should be noticed as a meeting of the full Harbor Safety Committee.

Section 4. Work Groups may be composed of any number of participants. Work Groups should operate by consensus of those present, including interested members of the public.

Section 5. Subcommittees and Work Groups may make recommendations to the full Committee, which will vote on the recommendations as detailed in Article VIII. Recommendations should be made in writing and provided to the Committee prior to any vote on the matter.

### **Article VI: Recommendations from Committee**

Section 1. The Committee shall make recommendations or requests to the Administrator on rules, regulations, guidelines and policies on Harbor Safety. The Committee may make recommendations or requests to other federal, state or local agencies.

Section 2. The Committee shall prepare and submit a Harbor Safety Plan and annual updates to the Administrator by July 1 of each year or as directed otherwise by the Administrator.

### **Article VII: Meetings**

Section 1. Governing rules for meetings shall be the Ralph M. Brown Act (Open Meetings for Local Legislative Bodies), the San Francisco Bay Region HSC bylaws, and Robert's Rules of Order.

Section 2. Each Committee member and alternate shall be provided a copy of the San Francisco Bay Region HSC bylaws and the Harbor Safety Plan. Upon request, Committee members and alternates, as well as interested parties, shall be provided a copy of the Brown Act.

Section 3. The Committee normally meets at 10:00 a.m. on the second Thursday of each month and rotates meeting locations to include the Ports of Oakland, Richmond and San Francisco or other relevant locations within the San Francisco Bay Region.

Section 4. Quorum

## **Appendix B**

In order for a meeting to take place, a quorum of appointed members or their alternates consisting of nine (9) individuals shall be present. Should a quorum not be present, the Committee can proceed as a committee of the whole, take public testimony, receive input on any agenda item duly noticed, but cannot take action on any item.

### Section 5. Agenda for Meetings:

- a. An agenda drafted by the Secretariat in consultation with the Committee Chair shall be prepared for each meeting of the Committee. The agenda shall be distributed to members, alternates, and interested parties no fewer than seven (7) days prior to the scheduled meeting and shall comply with all provisions of the Brown Act.
- b. In accordance with the Brown Act, agendas for full Committee meetings, and the schedule of upcoming workgroup and subcommittee meetings shall be posted 72 hours in advance at the Secretariat Offices. Postings shall be visible from the outside of building.
- c. Agendas shall include a brief general description of each item to be discussed, including whether a voting action is to be taken on an item.
- d. Each agenda item that requires Committee action shall include time for public comment.
- e. The Committee may take action on an item not appearing on the agenda by determining that an immediate need exists and it came to the attention of the Committee after the agenda was distributed. This determination must be approved by a two-thirds (2/3<sup>rd</sup>) vote of all appointed Committee members or, if less than two-thirds (2/3<sup>rd</sup>) of all appointed members are in attendance, by a unanimous vote of those appointed members present.
- f. A Committee member or member of the public may discuss an item not on the agenda under New Business/Public Comments. However, no action by the Committee can be taken until such time as the item is duly noticed at a regular or special meeting, and time has been allotted to receive public input prior to Committee action.

## **Article VIII: Voting**

### Section 1. Voting

- a. The San Francisco Bay Region Harbor Safety Plan annual review shall be approved by two-thirds (2/3rds) of the appointed Committee members or their alternates.



## **Appendix B**

- b. With the exception of items specified in Section 1a of this Article, Article VII, Section 5 e, and Article IX, passage of any item subject to a vote by Committee members shall require a simple majority of appointed members, or their alternates, present at a meeting. No action shall be taken on any item that is not on the agenda provided pursuant to Article VII, Section 5, except as allowed by Article VII, Section 5e.
- c. Due to the advisory nature of the Committee and its selected representatives, members shall not be excused from voting in case of potential conflict of interest.

### **Article IX: Bylaws Review, Acceptance and Amendments**

#### Section 1. Enactment or Amendment of Bylaws

To enact or amend the bylaws, the proposed bylaws must be:

- a. Included as an agenda item at a regular meeting.
- b. Noticed to the public in accordance with provisions of Article VII, Section 5, of these bylaws.
- c. Be approved by two-thirds (2/3rds) of the appointed Committee members or their alternates.

#### Section 2. Bylaws Status

- a. The bylaws shall become effective after Committee approval and shall continue in force until amended or repealed.

### **Article X: Certification**

I certify that these bylaws were approved by the Harbor Safety Committee of the San Francisco, San Pablo and Suisun Bays, including the Ports of Sacramento and Stockton, on October 9, 2003, at Richmond, California, by a vote of 16 yea to 0 nay. This document is true and correct, and constitutes the official bylaws governing the Committee. These bylaws shall remain in force until amended or repealed in accordance with Article IX.

## **Appendix C**

### **Annual Work Group Reports**

#### **Navigation Work Group**

Captain Bruce Horton, Chair  
S.F. Bar Pilots  
Pier 9, East End  
San Francisco, CA 94111  
Phone: (510) 326-3722  
b.horton@sfbarpilots.com

#### Accomplishments 2014/2015

1. Continued discussions with the USACE and Dredge Issues Work Group about maintaining dredged channels to their appropriate depths.
2. Saw through the installation of an air gap sensor on the Oakland Bay Bridge.
3. Met to discuss and review the Temporary Safety Guidelines and Critical Maneuvering Areas to determine if any changes were needed.
4. Formalized the change of the Temporary Safety Guidelines into Permanent Safety Guidelines.

#### Goals 2015/2016

1. Continue discussions with the USACE and Dredge Issues Work Group about maintaining dredged channels to their appropriate depths.
2. Assist the TUG Work Group with changing the HSC Escort regulations pertaining to speeds while piloting escorted ATBs.

## Appendix C

### Dredging Issues Work Group

Griffin Patrick, Co-Chair  
Port Captain – Northern California  
Tesoro Refining and Marketing Affairs  
150 Solano Way  
Martinez, California 94553-1465  
Phone: (925) 372-3015  
griffin.d.patrick@tsocorp.com

Michelle Connolly, Co-Chair  
Area Operations Mgr – San Francisco, CA  
Chevron Shipping Company  
841 Chevron Way  
Richmond, California 94801  
Phone: (510) 242-4630  
mconnolly@chevron.com

(Captain Esam Amso, Past Chair  
Valero Marketing and Supply Company)

### Accomplishments 2014/2015

1. Held Work Group meetings to discuss dredging strategy and schedule. Last meeting held May 29, 2014.
2. Coordinated with USACE, SF Bar Pilots, and involved Marine Oil Terminals and others prior to start of the dredge to ensure results in these navigation channels are beneficial to stakeholders. Reviewed pre-dredge soundings and discussed spoil dumping grounds to avoid return of the material to the navigation channels.
3. Through connections established at the Dredge Issues Work Group meetings and in conjunction with the SF Bar Pilots and Marine Oil Terminal Operators a physical geographic reference point was volunteered that assisted with the dredging of Bulls Head Channel and improved accuracy and efficiency. This would not have been possible without the cooperation and connections established at the Dredge Issues Work Group meeting.
4. Capt. T. Coppo discussed dredge target areas with his colleagues at SF Bar Pilots, those areas of concern were communicated to the ACOE and assisted with development of the dredge plan.
5. Pinole Shoal Channel was mainly dredged by the Essayons in 2014 and then surveyed. The USACE coordinated a spot follow-up dredging of Pinole Shoals using the dredge Yaquina. The Dredge Work Group helped strategize the best use of dredge time on Pinole Shoal Channel to maximize that follow-up dredging. The best results in many years were achieved.

## Appendix C

6. The USACE, both San Francisco and Sausalito offices, worked closely with the SF Bar Pilots and Chevron Shipping Docking Masters to perform follow-up dredging in the maneuvering area adjacent to Richmond Long Wharf. This second episode removed the “humps” barriers to safe navigation for getting into the North and South berths. Again the best results in many years were achieved due to close coordination for best utilization of dredging dollars.

### Goals 2015/2016

1. Maintain continued working relationships with USACE, SF Bar Pilots and other maritime/refinery parties.
2. Continue monitoring channel for any negative changes to ensure safe navigation.
3. Ensure dredge contactors has dredge plans that best suit stakeholders needs.
4. Improve pre-planning meetings with USACE to ensure project plans include controlling depth high-spots for most effective use of dredging funds. Close coordination with marine terminal personnel can help improve overall dredge results.
5. Continue condition surveys every two-three months.

## Appendix C

### Dredging Issues Work Group

Griffin Patrick, Co-Chair

Port Captain

Tesoro Refining and Marketing

150 Solano Way

Martinez, California 94553-1465

Phone: (925) 372-3015

[griffin.d.patrick@tsocorp.com](mailto:griffin.d.patrick@tsocorp.com)

Chad Culbertson, Co-Chair

Port Superintendent

Chevron Shipping Company LLC

841 Chevron Way

Richmond, California 94802

Phone: (510) 242-4630

[Chad.Culbertson@chevron.com](mailto:Chad.Culbertson@chevron.com)

#### Accomplishments 2015/2016

7. Held Work Group meetings to discuss dredging strategy and needs. Last few meetings held: 04-14-2016 / 07-20-2015 / 06-11-2015
8. 21 July 2015 - Letter send to Senator Dianne Feinstein – Topic: FY 2016 Support for Energy & Water Appropriations for Dredging
9. Coordinated with USACE, SF Bar Pilots, and involved stakeholders prior to the start of dredging to ensure results in all navigation channels were beneficial to stakeholders. Reviewed pre-dredge soundings and discussed key dredging locations that benefit safe navigation.
10. SF Bar Pilots discussed dredge target areas with the USACE and assisted with development of the dredge plans.
11. Pinole Shoal Channel was dredged by a contractor in 2015 and then surveyed. USACE coordinated a spot follow-up dredging of Pinole Shoal using the contractor to re-dredge missed areas. The Dredge Work Group helped strategize the best use of dredge time on Pinole Shoal Channel to maximize the follow-up dredging.
12. USACE, both the San Francisco and Sausalito offices, worked closely with the SF Bar Pilots and Chevron Shipping Docking Masters to perform dredging in the maneuvering area adjacent to Richmond Long Wharf.

#### Goals 2016/2017

6. Maintain working relationships with USACE, SF Bar Pilots and other maritime/refinery parties.
7. Draft second Appropriations for Dredging letter to Senator.
8. Continue monitoring channel for any negative changes to ensure safe navigation.
9. Ensure dredge contractors meet stakeholder's needs and voice any concerns.
10. Continue condition surveys every two-three months and monitor the need for emergency dredging to keep channels safe.

## **Appendix C**

### **Ferry Work Group**

Captain Tom Dougherty, Chair  
Blue & Gold Fleet  
1050 Nimitz Ave.  
Vallejo, CA 94592  
Phone: (415) 505-0203  
tfdoughertysfo@gmail.com

#### Accomplishments 2015/2016

1. Established a working dialogue with shared waterway users.
2. Presented ferry system operating reports and growth plans for discussion.

#### Goals 2016/17

1. Review Harbor Safety Plan, Chapter XI, Small Passenger Vessels – Ferries with existing and new stakeholders, and update as needed.
2. Continued dialog and outreach with other HSC stakeholders to promote safe practices with ferry operations.

## **Appendix C**

### **Navigation Work Group**

Captain Bruce Horton, Chair

S.F. Bar Pilots

Pier 9, East End

San Francisco, CA 94111

Phone: (510) 289-4185

b.horton@sfbarpilots.com

#### Accomplishments 2015/2016

1. Continued discussions with USACE and Dredge Issues Work Group about maintaining dredged channels to their appropriate depths.
2. Assisted the Tug Work Group with changing the HSC Escort Regulations pertaining to speeds while piloting escorted ATBs.
3. Met for a discussion concerning crab fishermen work lights and non-responsiveness to radio calls. Helped the USCG in drafting and publishing USCG MSIB 15-07.
4. Discussion considering changes to bunkering operations in Oakland Outer Harbor; present guidelines/BMPs found sufficient.
5. Assisted the USCG in creating berthing schemes for Anchorages 7 & 8, and proposed changes be made, which subsequently passed and were adopted.

#### Goals 2016/2017

1. Continue discussions with USACE and Dredge Issues Work Group about maintaining dredged channels to their appropriate depths.
2. Assist the Tug Work Group with researching if a standby assist tug is needed for the SF Bay Area.
3. Work with the Ferry Ops work group in establishing criteria to safely coordinate projected ferry growth in Oakland Inner Harbor.
4. Research and determine if some guidelines need to be established regarding issues with underwater pipelines and who is responsible for maintaining them and their depths.

## **Appendix C**

### **PORTS Work Group**

Chris Peterson, Chair  
Port of Oakland  
530 Water Street  
Oakland, CA 94607  
Phone: (510) 627-1308  
cpeterson@portoakland.com

#### Accomplishments 2015/16

No initiatives completed in 2015/2016.

#### Goals 2016/17

Installation of weather station at San Francisco Pier 27 cruise ship terminal.

Installation of tidal sensor on buoy off Oakland Berth 38.



## **Appendix C**

### **Prevention through People Work Group**

Margot Brown, Chair  
3217 Fiji Lane  
Alameda, California 94501  
Phone: (510) 523-2098  
Fax: (510) 523-2098  
mjbjhb@aol.com

#### Accomplishments 2015/16

1. Shared concerns about possible use of E15 fuels in recreational vessels.
2. Share concerns about marine spatial determinations.

#### Goals 2016/17

1. Continue to share safety concerns about use of E15 fuel in any recreational vessel.
2. Share concerns and recreational boating information and experience on West Coast Spatial considerations.
3. Continue to offer brochures/articles to improve recreational boating safety.

## **Appendix C**

### **Tug Work Group**

Robert Gregory, Chair  
Foss Maritime Co.  
1316 Canal Road  
Richmond, CA 94804  
bob@foss.com

#### Accomplishments 2015/16

1. Submitted request to the OSPR Administrator to allow ATBs to be able to use the Tanker Escort Matrix.
2. Received approval from the Administrator to use the Tanker Escort Matrix with ATBs that meet the tanker requirements.
3. Started the process of evaluating request from the Administrator to judge whether there are sufficient tug assets to assist in the emergency towing of a vessel within the geographic responsibility of the SF HSC.

#### Goals 2016/17

1. Complete the assessment required by SB 414, and provide the Administrator with a report concerning emergency tow capabilities.
2. Make recommendations to the Administrator regarding new draft language for regulations concerning the escort of ATBs in San Francisco Bay.
3. Reengage stakeholders to refresh Bunkering BMP.

## Appendix D

### Office of Spill Prevention and Response (OSPR) TUG ESCORT VIOLATION DISPOSITION SUMMARY REPORT FOR 2015 to 4/2016

#### VIOLATIONS TOTAL

Failure to Notify the S.F. Marine Exchange	2
Bollard Pull Certificate expired	0
Current Velocity violation	0
Not enough required Kips for the Zone	0
Escort Certification (none/expired)	1
Escort Plan and paperwork not in order	<u>0</u>
<b>TOTAL</b>	<b>3</b>

#### DISPOSITION TOTAL

Violation Dismissed	3
Hearing Waived/Case settled	1
Pending Dispositions ( <i>includes: 2013 pending settlement [1tug = 90 violations]</i> )	93

## Appendix D

TITLE 14, CALIFORNIA CODE OF REGULATIONS  
SUBDIVISION 4. OFFICE OF SPILL PREVENTION AND RESPONSE  
CHAPTER 4. VESSEL REQUIREMENTS  
SUBCHAPTER 1. TANK VESSEL ESCORT REGULATIONS  
FOR THE SAN FRANCISCO BAY REGION  
SECTIONS 851.1 through 851.10.1  
Amended September 15, 2006  
Effective October 15, 2006

<https://nrm.dfg.ca.gov/FileHandler.ashx?DocumentID=22000&inline>

### "851.1 Effective Date of this Subchapter"

This subchapter, as amended, shall be effective on June 9, 2004.

Note: Authority: Sections 8670.17.2(a), and 8670.23.1(d), Government Code.  
Reference: Sections 8670.17.2(b), 8670.23.1 (d), (e)(1) and (h) Government Code.

### "851.2 Purpose and Scope"

This subchapter sets forth tank vessel escort requirements for the San Francisco, San Pablo and Suisun Bays. These requirements specify that tank vessels carrying 5,000 or more long tons of oil in bulk as cargo shall be escorted by a suitable escort tug or tugs. The escort tugs will be available, and shall respond as needed to influence the speed and direction of travel of the tank vessel in the event of a casualty, or steering or propulsion failure, thereby reducing the possibility of groundings or collisions and the risk of oil spills from these tank vessels. This subchapter establishes the criteria for matching tugs to tankers and barges. Tankers will be matched according to a matrix that correlates a tanker's displacement with the braking force of a tug(s). Barges must be matched based on a one-to-one correlation of the deadweight tonnage of the barge to the braking force of the tug(s).

The Administrator shall review the matching criteria and other program elements within two years of the effective date of this subchapter. The program review will include a survey of the tanker-related incidents in U.S. waters to determine the types of failures that have occurred, an assessment of tug technology and any advances made in design and power, and the tug escort-related rules and policies that are implemented by other coastal states and maritime organizations. At the conclusion of the review, the Administrator will determine whether it is necessary to modify the tug/tanker matching criteria or any other provision of the program requirements.

Note: Authority: Sections 8670.17.2(a) & 8670.23.1(d), Government Code.  
Reference: Sections 8670.17.2(b) and 8670.23.1(e)(1), Government Code.

## Appendix D

### "851.3 Definitions"

Definitions governing the construction of this subchapter can be found in Government Code Section 8670.3, and Chapter 1 of this subdivision.

Note: Authority: Sections 8670.3, 8670.17.2(a) and 8670.23.1(d), Government Code.  
Reference: Section 8670.3 and 8670.17.2(a), Government Code.

### "851.4 Applicability"

- (a) This subchapter shall apply to all tank vessels capable of carrying 5,000 or more long tons of oil in bulk as cargo when these vessels are underway on waters in the San Francisco, San Pablo and Suisun Bays, as follows:
- (1) tank vessels carrying 5,000 or more long tons of oil as cargo shall be required to comply with all the requirements in this subchapter;
  - (2) tank vessels carrying less than 5,000 long tons of oil as cargo shall only be required to comply with the reporting requirement as stated in Subsection 851.7
- (b) The escort requirements of this subchapter shall not apply to tank vessels that are only shifting location within an anchorage. Any tug used during such a shifting maneuver need not be an escort tug registered with the Clearing House.
- (c) This subchapter shall not apply to tank vessels otherwise covered by the requirements of this subchapter in the event of an emergency. The master of the tank vessel shall report to the Clearing House any deviation from the requirements outlined in this subchapter as soon as practicable, and in no case later than the departure of the tank vessel from the marine waters of the state. For purposes of this section, an emergency shall include, but not be limited to, any of the following:
- (1) imminent and immediate danger to the vessel, its cargo, or its crew; or
  - (2) imminent and immediate danger to a marine terminal, or to the escort tug; or
  - (3) imminent and immediate danger to a vessel in close proximity to the tank vessel; or
  - (4) any emergency declared by the Captain of the Port.
- (d) This subchapter (except for this Subsection 851.4(d)) shall not apply to tankers with double hulls, as that term is defined in 33 CFR 157.03(kk), when the tanker also has the following:
- (1) Fully redundant steering and propulsion systems to include:

## Appendix D

- (A) two independent propulsion systems each with a dedicated propeller, engine (or motor), electrical generation system, electrical system (including the switchboard), fuel system, lube oil system, and any other system required to provide the vessel with independent means of propulsion; and
  - (B) two independent rudders each with separate steering systems; and
  - (C) the propulsion and steering components, as described in Subsection (A) and (B) above, shall be arranged in separate spaces, such that a fire or flood in one space will not affect the equivalent system in the other space(s); and
  - (D) a bow thruster with an assigned power source;
- (2) A Navigation System in compliance with the federal navigational equipment requirements set forth in 33 CFR Sections 164.35, 164.37, 164.38(b), 164.40, 164.41, 164.42, and 164.43.
  - (3) No exemption to this subchapter shall be allowed for a tanker requesting a U.S. Coast Guard Captain of the Port letter of deviation, pursuant to 33 CFR Sections 164.51, 164.53, and 164.55.
  - (4) The Administrator may require tankers that are exempt from this subchapter under the conditions outlined in Subsection (d) to periodically demonstrate the tanker and crew's ability to maneuver in response to a partial or total loss of propulsion and/or steering at a level of safety at least equal to that of an escorted tanker.
- (e) This subchapter shall apply to all tugs being used to escort tank vessels in waters identified as escort zones.
  - (f) The tank vessel master remains responsible for the safe navigation and maneuvering of the vessel in all circumstances. The requirements outlined in this section are in addition to, and not a limitation of, any other responsibility created by custom, law, or regulation.

Note: Authority: Sections 8670.17.2(a) and 8670.23.1(d), Government Code.  
Reference: Section 8670.23.1, Government Code.

### "851.5 Escort Zone Requirements"

- (a) Six tank vessel escort zones are established as follows:
  - (1) Zone 1: All waters in the area encompassed by a straight line drawn between Point Bonita Light, through Mile Rocks Light to the shore (the COLREGS Demarcation Line), and eastward to the Golden Gate Bridge;
  - (2) Zone 2: All waters from the Golden Gate Bridge, south to a line drawn between the southern tip of Bay Farm Island and the southeastern tip of Point San Bruno Peninsula, and north to a line drawn from Point San Pablo to San Pablo Bay Light 4 (Light List number 5880), to San Pablo Bay Channel Light

## Appendix D

5 (Light List number 5885), to Point San Pedro;

- (3) Zone 3: All waters from the southern end of Zone 2 to one mile north of the San Mateo Bridge;
  - (4) Zone 4: All waters in the navigable channel from one mile north of and to one mile south of the San Mateo Bridge;
  - (5) Zone 5: All waters from the eastern boundary of Zone 2 to the western approaches of the Carquinez Bridges at Light 15;
  - (6) Zone 6: All waters from Light 15, through the Carquinez Strait, north on the Sacramento Ship Channel to one mile beyond the Ryer Island Ferry Terminal and east on the San Joaquin River to one mile beyond the Antioch Bridge;
- (b) Tank vessels required to have escorts under this subchapter shall be escorted in the zones as specified below:
- (1) Escort tugs are required for tank vessels operating within Zones 1, 2, 4, or 6;
  - (2) Escort tugs will not be required in Zones 3 or 5, or in areas outside of Zones 1 through 6;
  - (3) No tank vessel may transit in a zone that requires an escort tug unless escorted by a tug or tugs of sufficient size and capability, as specified in sections 851.9 (for tankers) and 851.9.1 (for barges).
- o In Zone 1, escort tugs shall be stationed as follows:
- (A) on an inbound transit, the escort tug shall be in Zone 1 prior to the tank vessel's arrival to the area bounded by an arc eight nautical miles seaward of and centered on Mile Rocks Light; and
  - (B) on an outbound transit, the escort tug shall remain in Zone 1 until the tank vessel leaves the area bounded by an arc eight nautical miles seaward of and centered on Mile Rocks Light.

Note: Authority: Sections 8670.17.2(a) and 8670.23.1(d), Government Code.  
Reference: Section 8670.17.2(a), Government Code

### "851.5.1 Escort Plans"

- (a) All tank vessel masters shall use an Escort Plan for transits through zones 1, 2, 4, or 6. The tank vessel shall not continue or commence a transit through any Escort Zone without an Escort Plan that is complete and adequate. The plan shall document the steps that the tank vessel owner/operator and/or master will take to comply with the requirements of this subchapter. The Escort Plan requirements set forth in this section are only planning standards and may not reflect the exigencies of an actual incident

## Appendix D

response. However, the Escort Plan must demonstrate that the vessel master is prepared to take the actions necessary to assure a reasonable level of success in providing the protection intended by this subchapter, as stated in section 851.2. The Escort Plan shall include:

- (1) the tank vessel's intended route(s);
  - (2) the intended transit speed(s);
  - (3) a communication plan, to include the radio frequencies that will be used and any other means of electronic communication;
  - (4) the following characteristics of the tank vessel:
    - (A) the location and strength of the bits and chocks to be used by the escort tugs,
    - (B) the location of the pushing surfaces on the hull that are strong enough to sustain the forces that can be exerted by the escort tug(s),
    - (C) the number of crew assigned to escort-related duties,
    - (D) any pertinent performance characteristics and related limitations of the steering and propulsion system(s);
  - (4) the escort tugs to be used during the transit as required in section 851.9 (for tankers) or 851.9.1 (for barges);
  - (5) the response actions that will most likely be implemented in the event of an emergency, taking into account the available bits and chocks, pushing surfaces, line type, and expected tides and currents.
- (b) Escort Plans shall be prepared using one of the following:
- (1) a format as designed, completed and submitted by the tank vessel owner/operator; or
  - (2) a Checklist as recommended by the Harbor Safety Committee of the San Francisco Bay region, and approved by the Administrator. The vessel owner/operator shall assure that the vessel master completes the Checklist according to the requirements in this subchapter.
- (c) Review, approval and use of an Escort Plan designed and submitted by the tank vessel owner/operator:
- (1) a tank vessel owner/operator may develop an Escort Plan for a vessel or vessels, and submit that plan to the Administrator for review and approval prior to using the plan for escorted transits;
  - (2) the Escort Plan developed by the vessel owner/operator shall include all the information required in subsection 851.5.1(a). The requirement for information regarding the tug(s) to be used during the transit may be met by stating the size and braking force capacity of the tug(s) needed for each of the vessels covered by the plan.



## Appendix D

- (3) each plan shall be either approved, approved with conditions, or denied within 60 days after the Administrator receives the plan. Approval, once given, may be revoked if it is found that the plan submitter is not complying with the requirements of this subchapter;
  - (A) to be approved, the plan must comply with the requirements in this section, must match tug(s) to the tank vessels in accordance with the requirements in this subchapter, and must demonstrate that the tank vessel owner/operator and/or master maintains a level of readiness that will allow for effective implementation of the plan. The plan submitter shall be notified in writing when a plan has been approved.
  - (B) approval shall be denied or revoked if the plan, or the implementation of the plan, does not comply with the requirements of this subchapter. If a plan is denied or revoked, the Administrator shall notify the owner/operator in writing of the reasons for denial or revocation, and provide an explanation of those actions necessary to secure approval. The Checklist form of escort plan, as prescribed in this section, shall be used unless and until a new or revised escort plan is submitted and approved by the Administrator.
- (4) once approved, the master and pilot shall use and comply with the Escort Plan on each escorted transit:
  - (A) the details of the Escort Plan shall be reviewed and discussed as part of the pre-escort conference (section 851.7);
  - (B) as part of the pre-escort communications, the pilot or, if there is no pilot on board, the master shall notify the Clearing House that the plan has been reviewed, and shall inform the Clearing House of the tugs that have been chosen for the escort.
- (5) the Checklist format, as described in this section, shall be used for all escorted transits unless or until an Escort Plan is submitted by the vessel owner/operator, and approved by the Administrator.
- (d) Completion, review and use of Escort Plans prepared using the Checklist format developed by the Harbor Safety Committee:
  - (1) the Checklist shall include all the items enumerated in subsection 851.5.1(a), as well as a schematic drawing of a tank vessel sufficient to illustrate the location of the bits and chocks, and those areas on the hull that are capable of withstanding the forces exerted by the escort tug(s). The Administrator shall provide a copy of the approved Checklist to the Clearing House for distribution to tank vessel owner/operators, masters and/or pilots.
  - (2) the master shall complete the Checklist, and shall verify that all the requisite elements have been included. The master shall sign the Checklist to indicate that, to the best of the master's knowledge, the information on the Checklist is correct, and is in compliance with the

## Appendix D

requirements of this subchapter. If there is no pilot on board, the master shall notify the Clearing House when the Checklist has been completed and shall inform the Clearing House of the tugs that have been chosen for the escort. The Administrator may request a copy of any Checklist at any time to determine if the planning process has been completed adequately.

(3) the Checklist shall be completed by the tank vessel master at the following points during a transit operation;

(A) for vessels arriving from sea, the Checklist shall be completed prior to entering Zone 1;

1. Alternatively, the agent or owner/operator may complete the Checklist and electronically send the completed form to the master and the Clearing House:

a. before the vessel=s estimated time of arrival to the San Francisco Bay Pilotage area, or

b. before the vessel=s arrival at the San Francisco Bay Precautionary Area, or

c. after the vessel=s departure from its last Port of Call.

(B) for in-bay movements or for departures, the Checklist shall be completed prior to beginning the transit.

(4) if a pilot is on board, the pilot shall review the Checklist as cited in subsection 851.5.1(d) and shall verify that all the elements have been completed adequately. The pilot shall sign the Checklist after reviewing and verifying its adequacy. The pilot shall then notify the Clearing House that the planning process has been completed, and shall inform the Clearing House of the tugs that have been chosen for the escort.

(A) the pilot shall determine that the Checklist is adequate if the following are met:

1. all the items on the Checklist have been addressed completely; and

2. the information provided demonstrates that the tank vessel master is prepared to take the actions necessary to assure a reasonable level of success in using the escort tug(s) in response to a vessel casualty.

(B) if the pilot determines that the Checklist is not adequate, the pilot shall notify the Clearing House, and explain the reason(s) for such determination. The Clearing House shall then immediately notify the Administrator that a Checklist has been determined to be inadequate by the pilot.

## Appendix D

- (C) The Administrator shall review all inadequacy determinations made by a pilot and shall decide whether the determination is appropriate. The Administrator may affirm or overturn such determination, or may provide for conditional approval of a Checklist, as follows;
1. the Checklist will be considered adequate if it is complete, if the tug to tanker match has been done in accordance with this subchapter, and the information provided demonstrates that the tank vessel master is prepared to take the actions necessary to assure a reasonable level of success in using the escort tug(s) in response to a vessel casualty. If a Checklist is determined to be inadequate, the vessel may be ordered to discontinue operations until an adequate Checklist is completed;
  2. a Checklist may be approved conditionally if there is a minor deficiency in one or more of the requisite elements. Conditional approval may require that the tank vessel operate under specified precautionary measures (such as operating at a slower speed). If the owner/operator of a tank vessel fails to comply with the requirements of the conditional approval, the Administrator may order the tank vessel to discontinue operations until an acceptable Checklist for that vessel has been completed and approved.
- (D) The pilot is not responsible for delaying or stopping the transit solely because of a plan=s inadequacy.
- (5) The tank vessel owner/operator or the master shall ensure a copy of the completed, signed Checklist is submitted to the Clearing House within 14 days after the transit covered by the Checklist. The master, pilot, ship=s agent or vessel owner/operator may send the copy to the Clearing House. A copy of the Checklist shall also be maintained aboard the vessel for a period of one year after the transit. A copy of the Checklist shall be made available to the Administrator upon request.

Note: Authority: Sections 8670.17.2(a) & 8670.23.1(d), Government Code.  
Reference: Sections 8670.17.2(b) and 8670.23.1(e)(1), Government Code

### "851.6 Clearing House Responsibilities."

- (a) The Administrator shall establish a Clearing House which shall be responsible for performing escort compliance and monitoring duties, to include the following:
- (1) monitor, verify, and record the braking force of each escort tug that will be used to comply with this subchapter;
  - (2) ensure that the braking force measurement is certified by the American Bureau of Shipping

## Appendix D

(ABS) or by any member in the International Association of Classification Societies;

- (A) the braking force measurement shall be monitored by the Clearing House for those escort tugs that are tested in the San Francisco Bay region;
  - (B) escort tugs may be tested in another port if the braking force measurement is conducted in a manner consistent with the ABS (or equivalent) standards as used by the Clearing House. The tug owner/operator shall register such measurement with the Clearing House, and shall provide verification that the measurement complies with the ABS (or equivalent) standards.
- (3) maintain and publish a register which lists the following for each escort tug whose braking force is measured under this section:
- (A) the tug's name;
  - (B) the tug operator;
  - (C) the length of the tug;
  - (D) for tractor tugs, bollard pull ahead or astern, or the braking force determined by an alternate compliance model developed in accordance with the requirements of this subchapter;
  - (E) for conventional tugs, bollard pull astern;
  - (F) type and configuration of the propulsion system;
  - (G) type and configuration of the steering system;
- (4) receive notification of a tank vessel's arrival and/or movement as required under section 851.7;
- (5) receive notification of the displacement of a tanker, and the tug(s) chosen for an escorted transit. The Clearing House shall use this reported information to determine if the tanker is correctly matched to the escort tug(s) as required in this subchapter, and shall immediately report to the Administrator when such a match has not been done correctly. The verification shall be made prior to the tanker's arrival and/or movement. The Clearing House shall also be responsible for verifying the tug vessel's stability when these tugs are operating westward of the Golden Gate Bridge as specified in Section 851.8(f);
- (6) receive notification of the deadweight tonnage of a barge and the tug(s) that have been chosen for the escorted transit. The Clearing House shall use this reported information to determine if the barge is correctly matched to the escort tug(s) as required in this subchapter, and shall immediately report to the Administrator if the match has not been done correctly. The verification shall be made prior to the arrival and/or movement of the barge;

## Appendix D

- (7) maintain copies of blank Checklists for distribution upon request to tank vessel owner/operators, masters and/or pilots;
  - (8) receive notification of the completion of an Escort Plan, or the completion and adequacy of a Checklist, and report to the Administrator when a pilot makes a determination that a Checklist is not adequate;
  - (9) maintain copies of the completed Checklists submitted by the tank vessel owner/operators or masters. Copies must be kept for a period of 3 years from the date of the transit covered by the Checklist. A copy of any Checklist shall be made available to the Administrator upon request;
  - (10) receive reports from tug owners, operators or agents of any tug casualty that occurs during an escorted transit, and develop and maintain a database of all such casualty reports;
  - (11) monitor compliance with the requirements of this subchapter and report all violations to both the Office of Spill Prevention and Response and the Harbor Safety Committee for the San Francisco Bay Region.
- (b) The Administrator shall ensure that the duties of the Clearing House are performed in an effective and impartial manner. The Administrator may enter into a contract or establish a memorandum of understanding to designate an individual, organization, corporation or agency to operate as the Clearing House.
- (c) The Clearing House shall be authorized to assess and collect a fee to cover the costs incurred in complying with the tug escort requirements of this subchapter. The owner/operators of all escort tugs and all tank vessels required to have a tug escort shall pay the fee assessed by the Clearing House.

Note: Authority: Sections 8670.17.1, 8670.17.2(a) and 8670.23.1(d), Government Code.  
Reference: Section 8670.17.1 and 8670.23.1(e)(1), Government Code

### "851.7 Communication and Reporting Requirements Before, During and After an Escorted Transit"

- (a) No more than one hour prior to entering or transiting the marine waters of the San Francisco, San Pablo or Suisun Bays, the pilot or, if there is no pilot onboard, the master of a tank vessel shall report the vessel's name and position to the Clearing House, and shall report the status of the vessel as follows:
- (1) tank vessels carrying 5,000 or more long tons of oil as cargo shall report as "*Escort Required*"; or
  - (2) tank vessels carrying less than 5,000 long tons of oil as cargo and requiring no escort need not be reported.
- (b) After completing the review of the Checklist or the Escort Plan, as specified in section 851.5.1, the pilot

## Appendix D

or, if there is no pilot onboard, the master of the tank vessel shall report the following to the Clearing House:

- (1) a statement that the Escort Planning process has been completed;
  - (2) if a pilot is onboard, a statement from the pilot as to whether the Checklist is completed, and whether the Checklist is or is not adequate;
  - (3) a listing of the tugs that were chosen for the escort during the Escort Planning process;
  - (4) for a tanker, the vessel's displacement;
  - (5) for a barge, the vessel's deadweight tonnage.
- (c) Pre-Escort Conference: Before commencing an escorted transit, the pilot or, if there is no pilot onboard, the master of the tank vessel shall initiate communications with the escort tug(s). During this pre-escort conference, all parties shall plan and discuss the details of the escorted transit as specified on the Checklist or in the Escort Plan, including, but not limited to, the following:
- (1) the intended route;
  - (2) the intended destination;
  - (3) the speed of the vessel;
  - (4) the positioning of the escort tug(s) relative to the tank vessel being escorted;
  - (5) the manner in which an emergency connection would be made between the escort tug and tank vessel;
  - (6) radio communications, including primary and secondary frequencies; and
  - (7) anticipated weather and tidal conditions.
- (d) The master of the escort tug(s) shall report the name of the tug(s) and the name of the tank vessel to the Clearing House upon arrival at the following locations:
- (1) for inbound tank vessel movements; when passing Alcatraz, and when on-station;
  - (2) for in-bay and outbound tank vessel movements; when on-station at the tank vessel prior to movement of the tank vessel.
- (e) At all times during the escorted transit, the master or pilot of the tank vessel shall maintain direct, two-way radio communication with the master or pilot of the escort tug. The radio communication shall be on a channel agreed to by both the master or pilot of the tank vessel and the master or pilot of the escort

## Appendix D

tug.

- (f) Reporting tug casualties during and after an escorted transit:
- (1) the master of the escort tug shall immediately notify the master or pilot of the escorted vessel of any casualty that occurs to the tug during the escorted transit. A casualty shall include any loss of main propulsion, primary steering, or any component or system that reduces the maneuverability of the tug, or any other occurrence that adversely affects the tug's ability to perform the escort function;
  - (2) the tug owner, operator or agent shall file a written casualty report with the Clearing House within 72 hours of occurrence. The Clearing House shall maintain a database of these reports for three years.

Note: Authority: Sections 8670.17.2(a) & 8670.23.1(d), Government Code.  
Reference: Section 8670.23.1(e)(1), Government Code.

"851.8 Requirements for Escort Tugs; Braking Force Measurement, Crew and Training Standards, Equipment and Stationing Criteria."

- (a) Braking force measurement:
- (1) any escort tug used to comply with the requirements of this subchapter must have its braking force verified and registered with the Clearing House, as follows:
    - (A) for tractor tugs escorting in an ahead position the braking force is measured as the ahead bollard pull;
    - (B) for tractor tugs escorting in an astern position the braking force is measured as the astern bollard pull;
    - (C) for conventional tugs the braking force is measured as the astern bollard pull.
  - (2) The braking force shall be re-measured after any modifications and/or repairs to the main engines, hull, shaft-drive line, or steering, that could affect the bollard pull. The new measurements must be verified and registered with the Clearing House.
  - (3) The Clearing House shall publish procedures and standards to be followed when conducting braking force measurement. These procedures, entitled San Francisco Bay Region Clearing House, Rules for Bollard Pull Tests@, dated May 19, 2000, are incorporated by reference. These procedures and standards shall be made available upon request to the Clearing House.
  - (4) Any escort tug used to comply with the requirements of this subchapter shall also meet one of the following:

## Appendix D

- (A) the escort tug shall have its braking force re-measured within 3 years of its last bollard pull test, or;
  - (B) the escort tug shall submit to an Escort Tug Inspection Program, as follows:
    - 1. Escort tugs 150 gross tons or greater, and classed escort tugs shall be made available for inspection by the Administrator twice in five years during their dry dock examination. The period between inspections shall not exceed three years.
    - 2. Escort tug maintenance records shall be made available for inspection by the Administrator.
    - 3. If dry dock examination extensions are necessary, escort tugs shall comply with the direction of the cognizant Officer in Charge, Marine Inspection, or American Bureau of Shipping principal surveyors' direction.
    - 4. For classed escort tugs, a copy of the Class Surveyor's report confirming that the condition of the drive train (shafts, propellers, nozzles or other type drive) and main engines are in the same state as when the builder's or last bollard pull certificate was issued, shall be forwarded to the Administrator.
    - 5. Escort tug companies shall participate and have a certificate of compliance from one of the following Management Systems:
      - i. American Waterways Operators Responsible Carrier Program;
      - ii. International Safety Management;
      - iii. ISO 9000 (quality management).
    - 6. Escort tugs of less than 150 gross tons shall be made available for inspection by the Administrator once in five years during their dry dock examination. These escort tugs shall use a certified Marine Surveyor and shall comply with subsections 2, 3, and 4, above.
  - (C) Escort tugs that submit to the Escort Tug Inspection Program, as described above, can perform escort duties in any port in the state, if the tugs meet the requirements of the appropriate subchapter (i.e., Subchapter 1, San Francisco Bay Region; Subchapter 2, Los Angeles/Long Beach Harbor; Subchapter 3, Port Hueneme Harbor; Subchapter 4, Humboldt Bay; Subchapter 5, San Diego Harbor), of this Chapter 4 of the California Code of Regulations.
- (b) Any escort tug used to comply with the requirements of this subchapter, must meet crew standards as follows:
- (1) An escort tug shall have a minimum of four persons on board including one certified tug master and two certified deck hands. The fourth person shall be a crew member capable of resolving



## Appendix D

mechanical difficulties aboard an escort tug in the event of an emergency;

- (2) The requirement for four crew members does not preclude additional deck hands who are gaining experience for certification;
- (3) The certified deck hands required under this subsection shall at all times be awake, alert and ready to respond during an escorted transit. The fourth person must be immediately available to respond to any mechanical difficulties aboard the escort tug. Immediate response may be assured by an alarm or other signaling device to wake or alert the fourth person to the emergency.
  - (a) The Administrator may review the equipment and crew on an escort tug to assure compliance with this provision. The Administrator may require that the fourth person be awake and alert and ready to respond if the tug operator does not provide adequate mechanism to assure that the fourth person is immediately available to respond to a mechanical difficulty.
- (1) Working hours for escort crew members shall be limited to 15 hours in any 24-hour period, not to exceed 36 hours during any 72-hour period except in an emergency or a drill. Working hours shall include any administrative duties associated with the tug whether performed on board the tug or on shore.

(b) Training requirements for the crew of any escort tug used to comply with the requirements of this subchapter are as follows:

- (1) to qualify for certification as the master or deck hand on an escort tug, an applicant must do all of the following:
  - (A) possess a current and valid U.S. Coast Guard Merchant Mariner's Document;
  - (B) show proof of at least 960 hours on duty of prior service aboard a tug, at least 240 hours of which must have been in the San Francisco Bay region;
  - (C) successfully complete an approved education program which covers the following topics:
    1. basic tugboat seamanship;
    2. line handling skills;
    3. communication systems;
    4. emergency response to the loss of steering or propulsion on an escorted tank vessel and on the escort tug itself.

- o in addition to the requirements of subsection 851.8(c)(1), certification as the master of an escort tug requires that the applicant also do the following:

## Appendix D

- (A) possess a U.S. Coast Guard license appropriate to the escort tug in service; and
  - (B) show proof of an additional 240 hours on duty of service aboard a tug in the San Francisco Bay region (for a total of 480 of the requisite 960 hours of service); and
  - (C) successfully complete an approved education program which covers knowledge of local waters, basic seamanship, and the use of the escort tug in reducing the risk of an escorted vessel's grounding or collision.
- (2) individuals may be considered to have satisfied certain educational requirements without attending an education program, if they meet the following criteria:
- (A) an individual with a U.S. Coast Guard rating of Able Seaman Special (OSV) is considered to have met the educational requirements in subsection 851.8(c)(1)(C) 1 and 2;
  - (B) an individual with any Coast Guard license appropriate for the escort tug in service is considered to have met the educational requirements in subsections 851.8(c)(1)(C).
- (3) the Administrator shall review and approve the educational programs for masters and deck hands of escort tugs, and shall establish and maintain a list of all such approved programs:
- (A) an educational program shall be approved if it provides the coursework required by this section, and can adequately train students in the requisite skills;
  - (B) a request for approval of a program shall be submitted to the Administrator in writing and shall include the following:
    - 1. a description of the course content and materials;
    - 2. the qualifications of the instructors;
    - 3. the estimated cost of the program to the students;
    - 4. a description of the site(s) where the course will be held, both classroom and field locations.
  - (C) the Administrator shall notify the applicant of approval or denial within 30 days of the submittal of the application;
    - 1. if the educational program is denied, the applicant will be notified of the reasons for denial and may resubmit the program for review after the deficiencies have

## Appendix D

been remedied;

2. once approved, the educational program must be submitted for re-evaluation at least once every 5 years or when a significant change occurs in the course content or materials. The 5-year re-submittal shall include an updated description of course content, materials, cost, and instructor qualifications, as well as copies of student evaluations from classes conducted during the previous year;
3. the Administrator may audit the course at any time to assure compliance with the requirements of this section.

(4) The Administrator shall assure compliance with tug crew training and qualification requirements. Compliance with crew training and qualification requirements shall be verified as follows:

- (A) tug owner/operators shall establish and maintain adequate documentation to verify the training and qualifications of individual crew members, and shall make this information available to the Administrator upon request;
- (B) the Administrator may review the owner/operator's documentation annually to assure compliance with this section;
- (C) the Administrator may request this documentation at any time.

(c) The following equipment must be onboard an escort tug and in operable condition during all escorted transits;

- (1) a line-throwing gun for use in Zone 1, with 300 feet of tag line. The tag line shall be of suitable strength and size for deploying the tow line;
- (2) power line-handling equipment fore or aft for rapid, mechanically assisted deployment of lines. The primary line-handling equipment shall be in the position (fore or aft) best suited for the design of the particular tug in escort service;
- (3) tow line with a breaking strength that is 2.5 times the certified braking force of the escort tug;
- (4) a quick release device to be used when an escort tug is in a tethered mode;
- (5) one working radar;
- (6) fendering appropriate to absorb impact in skin-to-skin operations, and located at both the bow and stern to act as pivot points when pulling away from the tank vessel. In addition, the fendering must be sufficient to assure that there are no exposed corners, large holes or metal parts which could inflict damage on the escorted vessel, and must cover sufficient surface area to minimize sliding when working at an angle to the tank vessel.

## Appendix D

(d) Annual inspection of the escort tug's equipment:

- (1) the owner/operator shall assure that the required equipment is on board and operable during all escorted transits;
- (2) the Administrator shall verify that the required equipment is on board each escort tug, and in operable condition. This verification may be obtained by an annual inspection which may be announced or unannounced. In conducting such inspections, the Administrator shall be guided by the standards established by the American Waterways Operators (AWO) in their Responsible Carrier Program, Sections III and IV, dated 2/21/95.

(f) Stability requirements for all escort tugs that operate westward of the Golden Gate Bridge are as follows:

- (1) an escort tug shall have a load-line certificate; or
- (2) an escort tug shall have a letter verifying stability issued by the American Bureau of Shipping or any member in the International Association of Classification Societies. The letter shall establish that the escort tug complies with the stability requirements outlined in federal Load Line Regulations at 46 CFR, Sections 42.09-10(a), 42.09-15(a), (b), and (c) except subparagraphs (1) and (2), and 42.09-25 (a) and (b) except for the portion of the last line of (b) that reads "...and meeting applicable requirements in this subchapter"; and 46 CFR Sections 173.090, 173.095 and 174.145. A copy of this letter shall be kept on file with the Clearing House.

(g) Stationing requirements for escort tugs:

- (1) an escort tug shall not simultaneously engage in the escort of more than one tank vessel;
- (2) escort tugs shall maintain a station-keeping distance of no more than 1000 feet ahead or aside, or 500 feet astern of the tank vessel while engaged in escort activity;

(3) escort tugs shall standby as the tank vessel transits Zones 3 and/or 5, as follows:

- (A) the escort tug(s) shall standby in Zone 2 or 6 as the tank vessel transits Zone 5;  
and
  - (B) the escort tug(s) shall standby in Zone 2 or 4 as the tank vessel transits Zone 3; or
  - (C) the escort tug(s) may accompany the escorted tank vessel through Zone 3 and/or 5 in lieu of standing by.
- o in Zone 1, the escort tug(s) shall be stationed as follows:

- (A) on an inbound transit, the escort tug shall be in Zone 1 prior to the tank vessel's arrival to the area bounded by an arc eight nautical miles seaward of and centered on

## Appendix D

Mile Rocks Light; and

(B) on an outbound transit, the escort tug shall remain in Zone 1 until the tank vessel leaves the area bounded by an arc eight nautical miles seaward of and centered on Mile Rocks Light.

(h) Escort transit log:

- (1) escort tug masters shall keep a record in the ship's log of every escorted transit;
- (2) the record of the escorted transit in the ship's log shall include information regarding the sequence of events during the transit, the crew assignments, any casualties that may occur, and any drills conducted.

Note: Authority: Sections 8670.17.2(a) & 8670.23.1, Government Code.  
Reference: Section 8670.23.1, Government Code.

## Appendix D

### "851.9 Tanker and Tug Matching Criteria, and Tanker Crew and Equipment Requirements"

- (a) Default Matrix Option for Matching Tugs to Tankers: The tug or tugs used for an escorted transit shall be able to provide sufficient braking force to stop the escorted tanker from a speed of 5 knots through the water. The braking force of the tug(s) shall match the tanker's displacement, as indicated in the following matrix:

Assisting Current	Zones 1 and 2					Zones 4 and 6				
	slack	1 kt	2 kts	3 kts	4 kts	slack	1 kt	2 kts	3 kts	4 kts
Displacement*	Braking Force in kips (1,000 pounds of force)									
0 to < 20	20	<u>20</u>	30	<u>40</u>	40	40	<u>50</u>	70	<u>90</u>	110
20 to < 30	20	<u>30</u>	40	<u>50</u>	60	50	<u>70</u>	90	<u>120</u>	160
30 to < 40	30	<u>40</u>	50	<u>60</u>	70	60	<u>90</u>	120	<u>160</u>	210
40 to < 50	30	<u>40</u>	60	<u>70</u>	90	70	<u>110</u>	150	<u>200</u>	250
50 to < 60	40	<u>60</u>	70	<u>90</u>	110	100	<u>140</u>	190	<u>250</u>	320
60 to < 80	50	<u>70</u>	90	<u>120</u>	140	120	<u>180</u>	250	<u>330</u>	420
80 to < 100	60	<u>80</u>	110	<u>140</u>	180	150	<u>220</u>	300	<u>400</u>	520
100 to < 120	70	<u>100</u>	130	<u>170</u>	210	180	<u>270</u>	370	<u>500</u>	650
120 to < 140	80	<u>110</u>	150	<u>190</u>	240	210	<u>310</u>	430	<u>580</u>	760
140 to < 160	90	<u>140</u>	190	<u>240</u>	310	240	<u>350</u>	490	<u>660</u>	860
160 to < 180	100	<u>150</u>	210	<u>270</u>	350	260	<u>390</u>	550	<u>740</u>	970
180 to < 200	110	<u>170</u>	230	<u>300</u>	390	**	<u>**</u>	**	<u>**</u>	**
200 to < 220	120	<u>180</u>	250	<u>330</u>	420	**	<u>**</u>	**	<u>**</u>	**

\* 1,000 long tons

\*\* The channel depths in zones 4 and 6 limit vessels that may use the channel to those drawing less than 35 feet. This table does not address vessels in zones 4 and 6 with a displacement greater than 180,000 long tons because such vessels would draw more than 35 feet and would thus not be allowed into these zones.

- (1) Applicable current velocity: The current velocities shall be determined using the published tide and current tables developed and maintained by NOAA, and used by the pilots. The current velocity used shall be the one published for the estimated time of arrival at the points noted below. The estimated time of arrival shall include a window of 30 minutes before and

## Appendix D

after the scheduled arrival to account for possible delays or changes. Tank vessel operators are responsible for adjusting the estimated arrival time when it appears that it will fall outside of the originally estimated one hour window.

- (2) Location of current readings: The specific current velocity to be used in conjunction with the matrix shall be the published readings for the following locations:
  - (A) The Golden Gate Bridge - the predicted current velocity at the Golden Gate Bridge shall apply to vessels in zones 1 and 2 that are west of a north-south line drawn through the eastern tip of Alcatraz Island and terminating at Angel Island or to vessels in zones 1 and 2 that are west of the eastern entrance to Racoon Strait.
  - (B) The Bay Bridge; west of Yerba Buena Island - the predicted current velocity at the Bay Bridge shall apply to vessels in zone 2 that are south of an arc drawn from Alcatraz Island east to Treasure Island and east of the north-south line drawn through Alcatraz Island.
  - (C) 1.25 miles north of Point Chauncey - The predicted current velocity at 1.25 miles north of Pt. Chauncey shall apply to vessels in zone 2 that are north of an arc with a radius of 2.7 nautical miles centered at the intersection of the Bay Bridge and the San Francisco Peninsula drawn from Alcatraz Island east to Treasure Island and east of the north-south line drawn through the eastern tip of Alcatraz Island.
  - (D) The San Mateo Bridge The predicted current velocity at the San Mateo Bridge shall apply to vessels while in zone 4.
  - (E) The Carquinez Bridge - the predicted current velocity in Carquinez Strait shall apply to vessels in zone 6.

How to use the Default Matrix Option for Matching Tugs to Tankers: The matrix provides current velocities for slack water, 1, 2, 3, and 4 knots. The slack water column shall be used only when the water is truly slack. The 1 knot column shall be used for any velocity above 0 and equal to 1. The 2 knot column shall be used for any velocity above 1 and equal to 2, and so on up to the 4 knot maximum.

In those situations where the current velocity is above 4 knots, such as may occur at the Golden Gate, the tank vessel requiring an escort tug shall reschedule the transit to a time when the current velocity drops to 4 knots or below.

## Appendix D

- (b) Alternative To The Default Matrix for Matching Tugs to Tankers: Measurement methodologies other than those used to establish the Default Matrix may be used instead of, or in addition to, the Matrix as follows;
- (1) Alternate Compliance Model for Escort Tugs: Tug owner/operators may propose an alternate method for measuring the braking force of any tug (in kips). Such alternate method may be used to demonstrate that the tug can provide higher steering or braking forces (in kips) than the simple bollard pull measurement would indicate. An alternate measurement may only be submitted once in any 12 month period and shall comply with the following:
- (A) the owner/operator shall assure that the following are included when developing a methodology for calculating an alternate braking force for a given escort tug:
1. the alternate measurement is conducted from a starting speed of 10 knots for zones 1 and 2, and 8 knots for zones 4 and 6;
  2. the escort tug is not required to exceed the limits of its ability to generate the forces, and in no instance submerges the deck edge to achieve the alternate measurement;
  3. the escort tug operates all its equipment at or below the manufacturer's recommended guidelines for the safe working load of the tug;
  4. unless demonstrated otherwise by full scale testing, all machinery shall be assumed to operate at or below performance levels published by the manufacturer;
  5. any current bollard pull values registered with the Clearing House shall be utilized where appropriate in any formulas or models;
  6. any known condition that would impair the escort tug's ability to perform shall be included in the calculation.
- (B) the measurement must be conducted by a marine architect or engineer approved by the Administrator;
1. the tug owner/operator shall submit the name of the marine architect or engineer to the Administrator for approval prior to having that individual or his/her company conduct an alternate measurement.



## Appendix D

2. the Administrator shall approve a marine architect or engineer if that person has demonstrated the education, knowledge and experience necessary to conduct the testing and modeling of tug capabilities and braking force.
- (C) the alternate model and the resultant measurements shall be approved by the Administrator before the alternate model may be used to match a tanker to a tug or tugs. The Administrator shall approve the alternate model if it provides both of the following:
1. a higher force (in kips) than the simple bollard pull measurement would indicate; and
  2. at least the same level of protection as the braking forces established in the default matrix.
- (D) after an alternate model is approved, the Administrator shall provide the Clearing House with the new braking force measurements for the subject tug(s). The new measurements shall be used with the Default Matrix established in this section.
- (2) Alternate Compliance Model for Tankers: Tanker owner/operators may develop a model for the vessels in their fleet relative to the steering and braking demands of the vessels, and the braking capabilities of tugs. The steering and braking demands established by the alternate model may be used instead of the Default Matrix to match escort tugs to the tankers. An alternate compliance model may only be submitted once in any 12-month period and shall comply with the following:
- (A) the measurement must be conducted by a marine architect or engineer approved by the Administrator. The tanker owner/operator shall submit the name of the marine architect or engineer to the Administrator for approval prior to having that individual or his/her company conduct an alternate model;
1. the Administrator shall approve a marine architect or engineer if that person has demonstrated the education, knowledge and experience necessary to conduct the testing and modeling of tug capabilities and braking force.
- (B) the alternate model and the resultant measurements shall be approved by the Administrator before the alternate model may be used to match a tanker to a tug or tugs. The Administrator shall approve the alternate model if the following conditions are met:

## Appendix D

1. under the alternate model the tanker can complete a safe transit, staying within the 95th percentile of constraint as established in "The San Francisco Bay Tanker Escort Study", dated 7/95, prepared by Glosten Associates; and
  2. the alternate model provides at least the same level of protection as the braking forces established in the Default Matrix, and can be achieved using no more than three tugs as required in subsection 851.9(d).
- (C) After an alternate model is approved, the Administrator shall provide the Clearing House with the tanker demand in kips which corresponds to the tanker's displacement and speed under the approved alternate model.
- (c) The Administrator may allow deviations from compliance for the matching of tugs to laden tankers when these vessels make short transits from berth to berth within a zone and are assisted by docking tugs and transiting at speeds less than 8 knots.
- (1) The tanker master or owner/operator shall make a request for such deviations to the Administrator through the Clearing House at least 24 hours prior to the desired shift.
  - (2) The Administrator shall approve or deny the deviation request by verbally notifying the Clearing House within 12 hours of the request. A written confirmation shall follow within 24 hours.
- (d) Maximum number of tugs to be used during an escorted transit:
- (1) the tanker must be accompanied by a sufficient number, but no more than three tugs to provide the braking forces specified in this section;
- (e) Speed limits for tankers are as follows:
- (1) tankers that use the Default Matrix as provided in this section, shall not proceed at a speed in excess of 10 knots through the water in Zones 1, 2, 3 and 5, nor more than 8 knots through the water in Zones 4 and 6, with the following qualifications:
    - (A) the speed or speeds selected by the tanker for the transit must permit stationing the escort tug(s) to allow the tug(s) to effectively influence the tanker's movement in the event of a casualty;
    - (B) the tanker shall proceed at a safe speed. The determination of a safe speed shall include, but not be limited to;

## Appendix D

1. environmental factors such as the depth of the water, visibility, wind conditions, and the speed of the tidal currents; and
  2. proximity of other vessel traffic and any other vessels at anchor.
- (C) Tankers shall in any case have their engines ready for immediate maneuver and shall not operate in any control modes or with fuels that prevent an immediate response to an engine order.
- (2) tank vessels may be exempt from the speed limits specified in subsection 851.9(e)(1) if they establish and use an approved alternate compliance model for determining the steering and braking demands of their vessels, as provided in this section. In such cases, the speed limit will be that used to establish the alternate compliance model, and must be specified in the Escort Plan, or on the Checklist.
- (f) Crew requirements:
- (1) a tanker shall have sufficient and qualified line-handling-capable crew members standing by and available to immediately receive lines from each escort tug. These crew shall be stationed proximate to the lines, and shall not be assigned duties that would interfere with their ability to immediately respond to an emergency situation;
  - (2) the tanker shall comply with all applicable federal regulations relating to anchor readiness;
  - (3) tankers shall have sufficient and qualified supervisors to provide direct supervision of line-handling crew operations. Supervisors shall have direct radio communication capability with the bridge of the tanker.
- (g) Equipment requirements:
- (1) each tanker shall have deck chocks and bitts that are of sufficient size, strength, and number to accommodate the anticipated braking force of the escort tug(s);
  - (2) the tanker owner/operator shall indicate the location and strength of the bitts and chocks in the Escort Plan for each vessel.

Note: Authority: Sections 8670.17.2(a) & 8670.23.1(d), Government Code.  
Reference: Section 8670.23.1(e)(1), Government Code

"851.9.1 Barge and Tug Matching Criteria, and Barge Crew and Equipment Requirements"

## Appendix D

- (a) A barge must be accompanied by a sufficient number, but no more than three tugs to provide the braking force specified in this section;
  - (1) the line-haul tug which provides the power to push or tow a barge shall not become an escort tug during the course of a transit unless the line-haul tug has been relieved of its duties as the primary towing vessel, and replaced with another tug that serves as primary towing vessel.
  - (2) any line-haul tug that does become the escort tug after being relieved of all line-haul duties, must meet all the requirements for escort tugs as specified in this subchapter.
- (b) The tug or tugs used to escort a barge must be able to provide sufficient braking force to stop the barge, measured as follows:
  - (1) the braking force shall be measured as the escort tug's astern static bollard pull;
  - (2) the escort tug shall have total astern static bollard pull in pounds equal to, not less than, the barge's deadweight tonnage;
- (c) A barge shall not exceed 8 knots through the water during an escorted transit.
- (d) Crew Requirements:
  - (1) A barge shall have sufficient and qualified line-handling-capable deck hands onboard the barge, standing by and available to receive lines from each escort tug;
    - (A) the deck hands for the barge shall be made available from the line-haul tug;
    - (B) in the interest of crew safety, when entering or leaving Zone 2 bound to or from the sea (Golden Gate Bridge), crew transfers to or from the barge may be made in the vicinity of Alcatraz Island;
    - (C) when a barge is fitted with an emergency tow wire, or comparable mechanical device of sufficient strength and handling characteristics to control the barge, or the escort tug is made fast to the barge, deck hands shall not be required on board the barge.
  - (2) Barges shall have sufficient and qualified supervisors to provide direct supervision of line-handling crew operations. Supervisors shall have direct radio communication capability with the bridge of the tug that is towing the barge.

## Appendix D

(e) Equipment requirements:

- (1) each barge shall have deck chocks and bitts that are of sufficient size, strength and number to accommodate the anticipated braking force of the escort tug(s);
- (2) the barge owner/operator shall indicate the location and strength of the bitts and chocks in the Escort Plan for each vessel or on the Checklist for each transit.

Note: Authority: Sections 8670.17.2(a) & 8670.23.1(d), Government Code.  
Reference: Section 8670.23.1(e)(1), Government Code

### "851.10 Penalties

Any person who knowingly, intentionally or negligently violates any provision of this subchapter shall be subject to criminal, civil, and/or administrative civil actions as prescribed in Article 9, Government Code, beginning with Section 8670.57.

Note: Authority: Sections 8670.17.2(a) & 8670.23.1, Government Code.  
Reference: Sections 8670.23.1 and Sections 8670.57 through 8670.69.6, Government Code.

### "851.10.1 Requests for Redetermination"

The owner/operator of a tank vessel or an escort tug may request redetermination of an action taken relative to an inadequacy decision or conditional approval of an Escort Plan or Checklist, denial or revocation of approval of an educational program, or application for use of an alternative compliance model. A request for redetermination must be submitted in writing and shall be processed as follows:

- (a) the request must be submitted to the Administrator within 15 calendar days from the date of the decision being disputed;
- (b) the request must contain the basis for the redetermination and, if available, provide evidence which rebuts the basis for the decision;
- (c) within 15 calendar days following the receipt of the request for redetermination, a notice shall be sent indicating that the Administrator shall adhere to the earlier decision or that the decision has been modified or rescinded.

Note: Authority: Sections 8670.17.2(a) and 8670.23.1, Government Code.  
Reference: Sections 8670.23.1 and Sections 8670.57 through 8670.69.6, Government Code.

## Appendix E

# San Francisco Region Certified Escort Vessels

<http://www.sfmh.org/support/hsc/kipsratings/KIPSRatings.htm>

Tug	Boat ID	LOA	Propulsion System	Number	Rudders	Flanking Rudders	Kips Zones 1 & 2	Kips Zones 4 & 6	Certification Expires
<b>AmNav Maritime Services</b>									
DELTA LINDSAY	ANDL	100	Z-Drive	2	0	0	174.69	174.69	01-Jan-2103
FREEDOM	ANFR	86	Z-Drive	2	0	0	101.09	101.09	25-Nov-18
INDEPENDENCE	ANIN	93.6	Z-Drive	2	0	0	190.00	180.00	01-Jan-2103
LIBERTY	ANLB	95.2	Z-Drive	2	0	0	79.47	79.47	01-Jan-2103
PATRICIA ANN	ANPA	93.6	Z-Drive	2	0	0	190.00	180.00	01-Jan-2103
PATRIOT	ANPT	87.9	Conventional, Open	2	2	0	65.98	65.98	01-Jan-2103
REVOLUTION	ANRV	93.6	Z-Drive	2	0	0	190.00	180.00	01-Jan-2103
SANDRA HUGH	ANSH	93.6	Z-Drive	2	0	0	190.00	180.00	01-Jan-2103
<b>Baydelta Maritime</b>									
DELTA BILLIE	BDDB	93	Z-Drive	2	0	0	266.00	264.00	01-Jan-2103
DELTA CATHRYN	BDCN	93	Z-Drive	2	0	0	266.00	264.00	01-Jan-2103
DELTA DEANNA	BDDD	105	Z-Drive	2	0	0	188.00	171.00	01-Jan-2103
DELTA LINDA	BDLA	105	Z-Drive	2	0	0	188.00	171.00	01-Jan-2103
<b>Crowley Marine Services</b>									
GOLIAH	CMGA	105	Z-Drive	2	0	0	188.00	171.00	01-Jan-2103
GUARD	CMGU	120	Cycloidal	2	0	0	210.00	190.00	01-Jan-2103

Monday, April 04, 2016

Page 1 of 3

Vessels with an expiration date after January 1, 2100 are participants in the Escort Tug Inspection Program. So long as a vessels standing in the Escort Tug Inspection Program is maintained, its certification will not expire. The Escort Tug Inspection Program.

## Appendix E

Tug	Boat ID	LOA	Propulsion System	Number	Rudders	Flanking Rudders	Kips Zones 1 & 2	Kips Zones 4 & 6	Certification Expires
TIOGA	CMTI	85	Z-Drive	2	0	0	133.00	115.00	01-Jan-2103
VALOR	CMVR	93	Z-Drive	2	0	0	266.00	264.00	01-Jan-2103
VETERAN	CMVT	100	Z-Drive	2	0	0	266.00	264.00	20-Jun-17
<b>Foss Maritime</b>									
AMERICA	FMAA	98	Z-Drive	2	0	0	248.00	225.00	01-Jan-2103
ARTHUR FOSS	FMAR	102	Cycloidal	2	0	0	188.00	153.00	01-Jan-2103
BRYNN FOSS	FMBF	100	Cycloidal	2	0	0	140.00	134.00	01-Jan-2103
KEEGAN FOSS	FMKF	110	Conventional, Kort	2	2	4	73.31	73.31	01-Jan-2103
LYNN MARIE	FMLM	98	Z-Drive	2	0	0	210.00	200.00	01-Jan-2103
MARSHALL FOSS	FMMF	92.2	Z-Drive	2	0	0	210.00	200.00	01-Jan-2103
PACIFIC STAR	FMPS	98	Z-Drive	2	0	0	248.00	225.00	01-Jan-2103
POINT FERMIN	FMPF	32	Conventional, Open	2	2	0	44.79	44.79	01-Jan-2103
POINT VICENTE	FMPV	105	Conventional, Open	2	3	0	47.05	47.05	01-Jan-2103
<b>Oscar Niemeth Towing</b>									
SILVER EAGLE	ONSI	102.5	Z-Drive	2		0	98.14	98.14	28-Mar-19
<b>Starlight Marine Services, Inc.</b>									
AHBRA FRANCO	STAF	98	Z-Drive	2	0	0	237.00	237.00	01-Jan-2103
JOHN QUIGG	STJQ	76	Z-Drive	2	0	0	91.05	91.05	01-Jan-2103
LELA FRANCO	STLF	80	Z-Drive	2	0	0	125.90	125.90	30-Jun-18
MICHELLE SLOAN	STMI	80	Z-Drive	2	0	0	130.80	130.80	15-Apr-18

Monday, April 04, 2016

Page 2 of 3

**Vessels with an expiration date after January 1, 2100 are participants in the Escort Tug Inspection Program. So long as a vessels standing in the Escort Tug Inspection Program is maintained, its certification will not expire. The Escort Tug Inspection Program.**

## Appendix E

Tug	Boat ID	LOA	Propulsion System	Number	Rudders	Flanking Rudders	Kips Zones 1 & 2	Kips Zones 4 & 6	Certification Expires
MILLENNIUM DAWN	STMD	105	Z-Drive	2	0	0	181.00	168.00	01-Jan-2103
MILLENNIUM	STMF	105	Z-Drive	2	0	0	181.00	168.00	01-Jan-2103
MILLENNIUM STAR	STMS	105	Z-Drive	2	0	0	181.00	168.00	01-Jan-2103
ROBERT FRANCO	STRF	100	Z-Drive	2	0	0	178.00	178.00	01-Jan-2103
ROYAL MELBOURNE	STRM	77.4	Conventional, Open	2	2	0	38.21	38.21	01-Jan-2103
TIM QUIGG	STTQ	80	Z-Drive	2	0	0	90.35	90.35	01-Jan-2103
Z-FIVE	STZ5	95	Z-Drive	2	0	0	128.00	132.00	01-Jan-2103
Z-FOUR	STZ4	95	Z-Drive	2	0	0	128.00	132.00	01-Jan-2103
Z-THREE	STZ3	95	Z-Drive	2	0	0	128.00	132.00	01-Jan-2103
<b>Westar Marine Services</b>									
BEARCAT	WSBC	69	Conventional, Open	2	2	0	18.79	18.79	01-Jan-2103
ORION	WSOR	100	Conventional, Open	2	2	0	43.79	43.79	01-Jan-2103
SAGITTARIAN	WSSA	79	Conventional, Open	2	2	0	42.33	42.33	01-Jan-2103
SCORPIUS	WSSC	124	Conventional, Kort	2	4	0	74.94	74.94	01-Jan-2103
TAURUS	WSTS	69	Conventional, Kort	2	2	0	25.04	25.04	01-Jan-2103

Monday, April 04, 2016

Page 3 of 3

**Vessels with an expiration date after January 1, 2100 are participants in the Escort Tug Inspection Program. So long as a vessels standing in the Escort Tug Inspection Program is maintained, its certification will not expire. The Escort Tug Inspection Program.**



## Appendix F

### San Francisco Bay Clearinghouse Report For 2015

#### San Francisco Bay Region Totals

	<u>2015</u>		<u>2014</u>	
Tanker arrivals to San Francisco Bay	691		721	
ATB arrivals	108			
Barge arrivals to San Francisco Bay	256		288	
Total Tanker and Barge Arrivals	947		1,009	
Tank ship movements & escorted barge movements	3,806		3,387	
Tank ship movements	2,120	55.70%	1,748	51.61%
Escorted tank ship movements	1,376	36.15%	1,188	35.08%
Unescorted tank ship movements	744	19.55%	560	16.53%
Tank barge movements	1,686	44.30%	1,639	48.39%
Escorted tank barge movements	479	12.59%	401	11.84%
Unescorted tank barge movements	1,207	31.71%	1,238	36.55%

Percentages above are percent of total tank ship movements & escorted barge movements for each item.

Escorts reported to OSPR 3 5

<b>Movements by Zone</b>	<b>Zone 1</b>	<b>%</b>	<b>Zone 2</b>	<b>%</b>	<b>Zone 4</b>	<b>%</b>	<b>Zone 6</b>	<b>%</b>	<b>Total</b>	<b>%</b>
Total movements	2,326		3,707		0		1,693		7,726	
Unescorted movements	1,055	45.36%	1,890	50.98%	0	0.00%	897	52.98%	3,842	49.73%
Tank ships	755	32.46%	1,245	33.59%	0	0.00%	568	33.55%	2,568	33.24%
Tank barges	300	12.90%	645	17.40%	0	0.00%	329	19.43%	1,274	16.49%
Escorted movements	1,271	54.64%	1,817	49.02%	0	0.00%	796	47.02%	3,884	50.27%
Tank ships	1,017	43.72%	1,360	36.69%	0	0.00%	553	32.66%	2,930	37.92%
Tank barges	254	10.92%	457	12.33%	0	0.00%	243	14.35%	954	12.35%

Notes:

1. Information is only noted for zones where escorts are required.
2. All percentages are percent of total movements for the zone.
3. Every movement is counted in each zone transited during the movement.
4. Total movements is the total of all unescorted movements and all escorted movements.

# Appendix F

## Total Escort Movements in San Francisco Bay for 2015

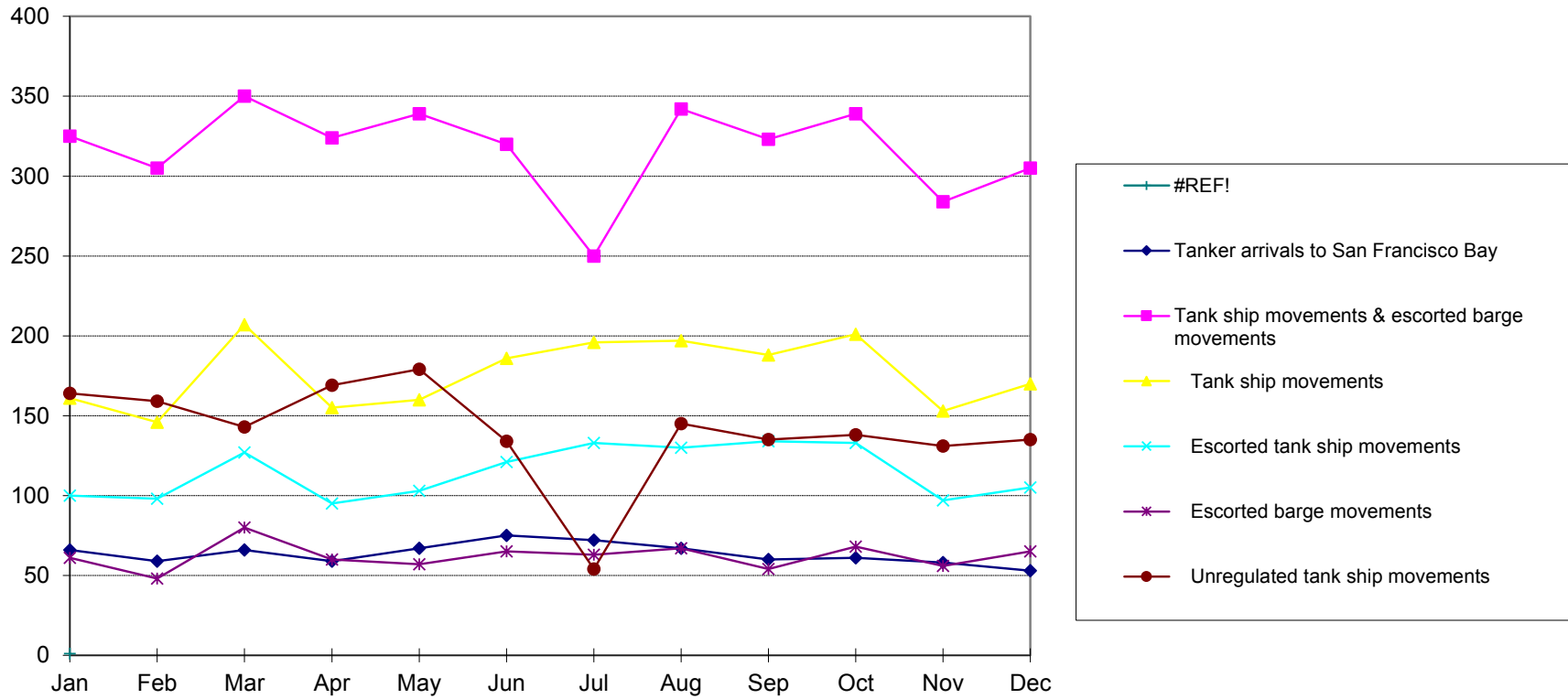

# Appendix F

## Zone 1 Totals for 2015

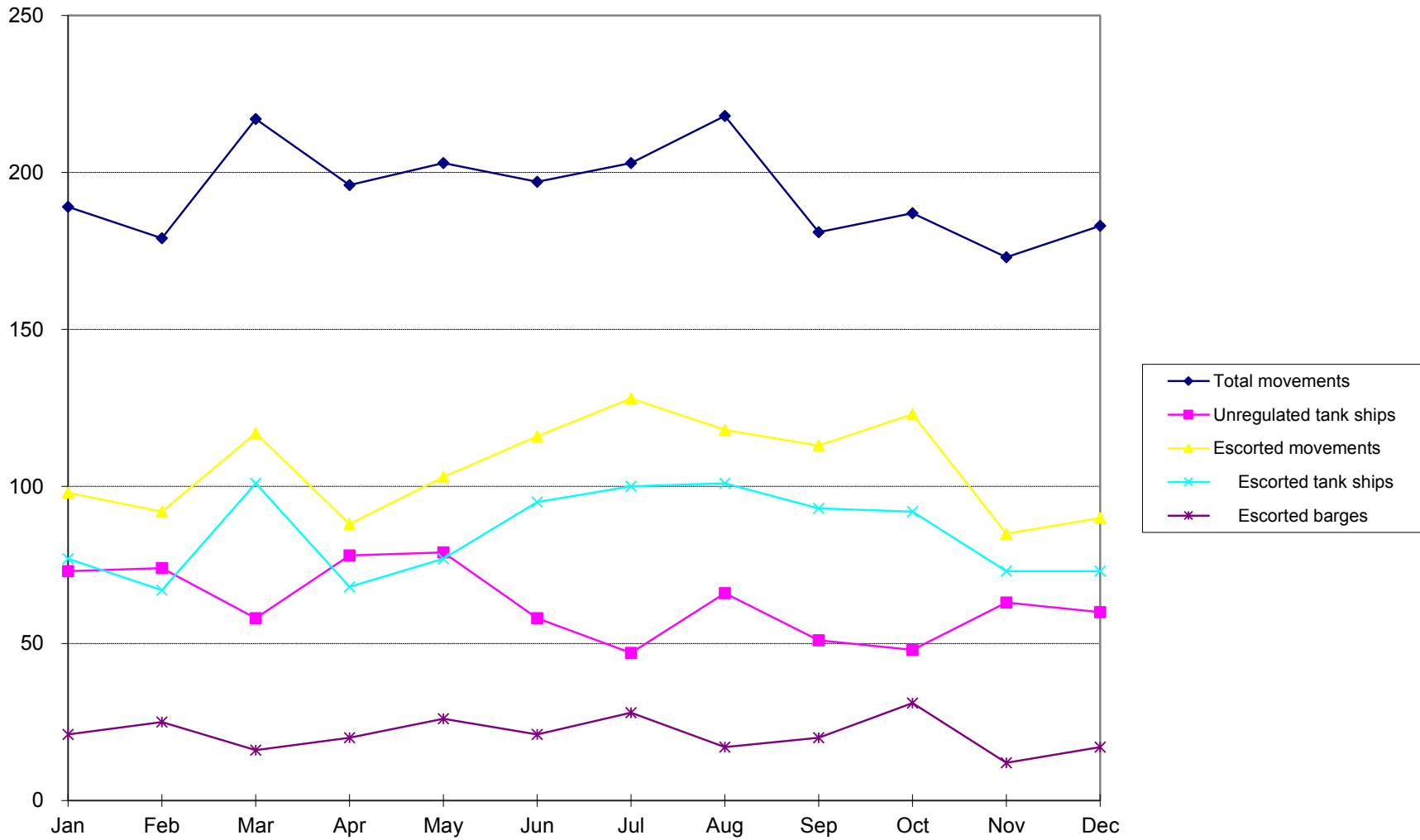

# Appendix F

## Zone 2 Totals for 2015

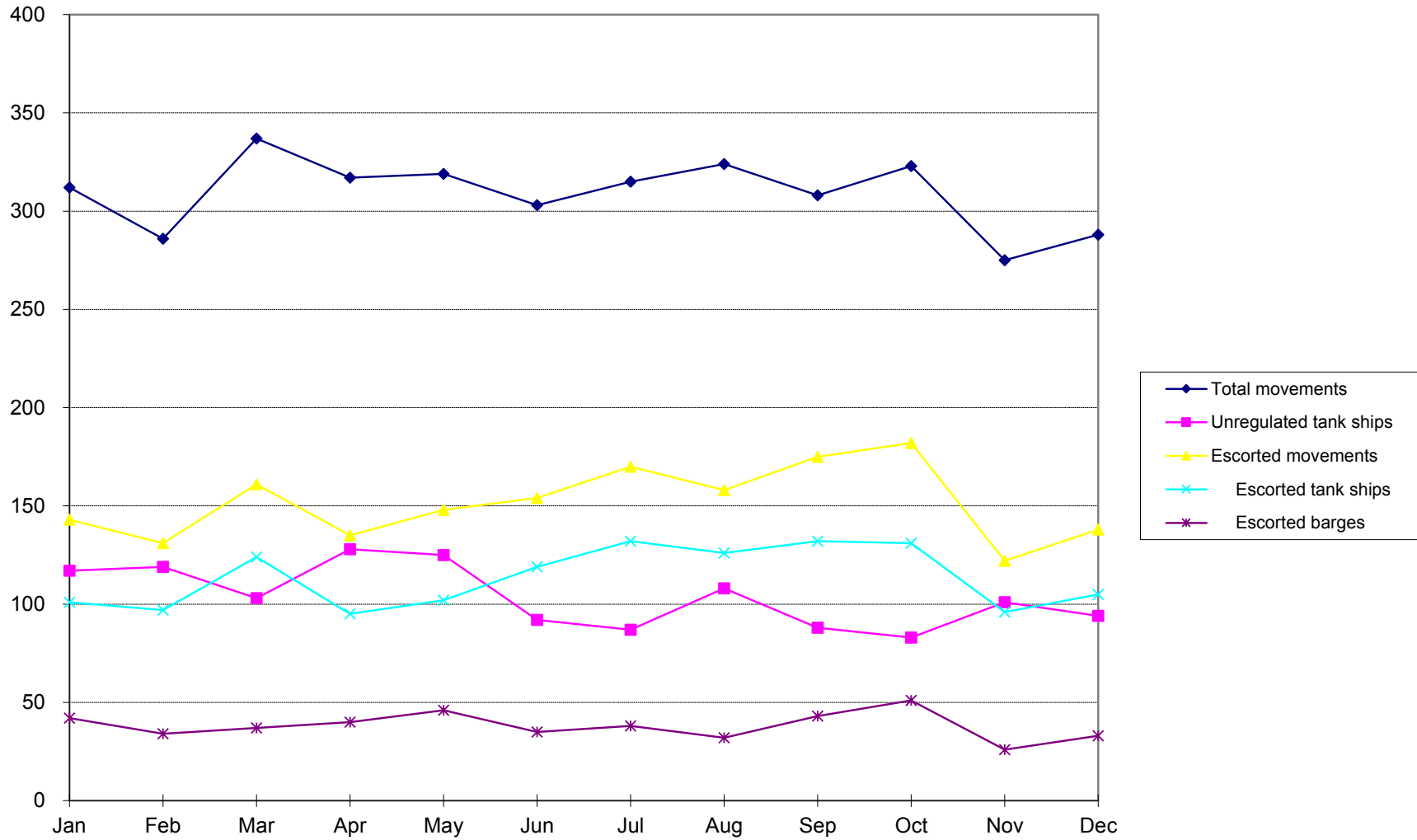

# Appendix F

## Zone 6 Totals for 2015

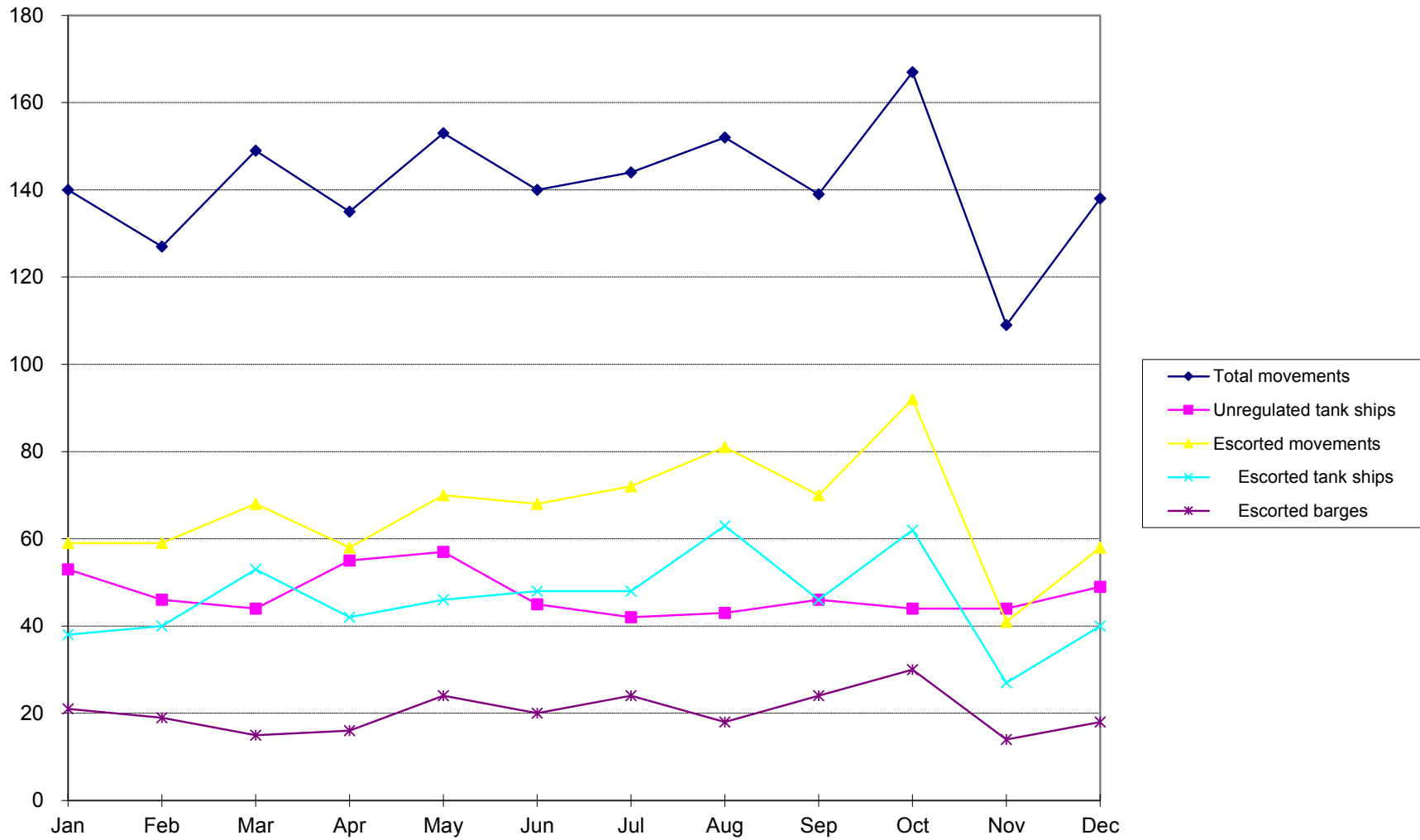

## Appendix G



Harbor Safety Committee of the  
San Francisco Bay Region Clearing House  
c/o Marine Exchange of the San Francisco Bay Region  
505 Beach Street, Suite 300  
San Francisco, California 94133-1131  
415-441-6600 fax 415-441-3080 [hsc@sfmtx.org](mailto:hsc@sfmtx.org)

### Comparative Vessel Movement Totals

	<b>2013</b>	<b>2014</b>	<b>2015</b>
Total vessel arrivals	3,587	3,474	3,236
Total vessel interbay shifts	2,109	2,253	2,478
Total tanker arrivals	1,145	1,079	1,159
Total tanker interbay shifts	1,578	1,501	1,555

## Appendix G

### 2015 Tank Vessel Arrivals

NAME	FLAG	Type	DWT	LOA	Arrivals
550-1	USA	ARTICULATED OTB	20,000	151	3
550-2	USA	ARTICULATED OTB	14,999	152	3
550-3	USA	ARTICULATED OTB	20,000	156	5
650-10	USA	ARTICULATED OTB	27,786	179	19
650-2	USA	ARTICULATED OTB	27,455	179	47
650-6	USA	ARTICULATED OTB	27,000	179	6
650-7	USA	ARTICULATED OTB	27,023	179	10
ADAFERA	MLT	CRUDE OIL TANKER	105,215	239	8
AEGEAN NOBILITY	GRC	CRUDE OIL TANKER	115,814	249	3
AFRICAN SPIRIT	BHS	CRUDE OIL TANKER	151,736	269	2
ALASKAN FRONTIER	USA	CRUDE OIL TANKER	193,050	287	1
ALASKAN NAVIGATOR	USA	CRUDE OIL TANKER	193,048	290	1
ALBERTA	BHS	CRUDE OIL TANKER	104,760	229	1
ALEXANDROS II	MHL	PRODUCT TANKER	51,257	183	1
ALIAKMON	LBR	PRODUCT TANKER	61,284	213	1
ALLEGRO	LBR	CHEMICAL/OIL TANKER	46,184	183	1
ALPINE MAYA	HKG	CHEMICAL/OIL TANKER	51,501	183	1
ALSEA BAY	USA	TANK BARGE	9,075	115	34
AMAGI GALAXY	MHL	CHEMICAL/OIL TANKER	26,198	159	5
ANNE ELIZABETH	USA	TANK BARGE	5,658	74	1
ANTARES	USA	TANK BARGE	11,500	103	27
ANTIMILOS	GRC	PRODUCT TANKER	72,514	228	1
AQUALEADER	LBR	CRUDE OIL TANKER	115,669	249	2
AQUALEGACY	LBR	CRUDE OIL TANKER	115,764	249	6
AQUALEGEND	LBR	CRUDE OIL TANKER	115,571	249	5
AQUALIBERTY	LBR	CRUDE OIL TANKER	115,649	249	2
AQUALOYALTY	LBR	CRUDE OIL TANKER	115,594	249	5
AQUAMARINE II	MHL	CHEMICAL/OIL TANKER	50,300	183	1
ARCTIC BRIDGE	MLT	CHEMICAL/OIL TANKER	50,903	183	1
ARDMORE CHEYENNE	MHL	CHEMICAL/OIL TANKER	25,000	159	2

## Appendix G

NAME	FLAG	Type	DWT	LOA	Arrivals
ARDMORE CHIPPEWA	MHL	PRODUCT TANKER	25,000	159	1
ARGENT EYEBRIGHT	PAN	CHEMICAL TANKER	33,609	170	3
ARGENT FREESIA	PAN	CHEMICAL/OIL TANKER	34,569	178	1
ARGENT IRIS	MHL	PRODUCT TANKER	34,862	174	1
ARGENT SUNRISE	PAN	CHEMICAL TANKER	36,580	183	2
ARIES SUN	LBR	CRUDE OIL TANKER	115,567	244	1
ARIONAS	MHL	CHEMICAL/OIL TANKER	37,627	184	1
ASOPOS	LBR	PRODUCT TANKER	61,286	213	3
ATLANTIC FRONTIER	HKG	CHEMICAL/OIL TANKER	47,128	183	2
ATLANTIC QUEEN	HKG	PRODUCT TANKER	46,838	183	3
AZALEA GALAXY	PAN	CHEMICAL TANKER	19,998	148	4
BERENIKE	MHL	CHEMICAL/OIL TANKER	39,575	183	1
BLUE RIVER	LBR	PRODUCT TANKER	106,638	240	1
BOX	MHL	CHEMICAL/OIL TANKER	50,577	183	1
BRITISH CHIVALRY	IOM	CHEMICAL/OIL TANKER	46,803	183	1
BRITISH MALLARD	IOM	CRUDE OIL TANKER	11,476	250	1
BW KRONBORG	SGP	PRODUCT TANKER	73,708	229	1
BW LEOPARD	SGP	PRODUCT TANKER	49,999	183	1
BW MIA	IOM	CHEMICAL TANKER	19,702	144	2
BW PUMA	SGP	PRODUCT TANKER	49,999	183	1
BW STREAM	IOM	CHEMICAL TANKER	19,998	136	1
BW TIGER	SGP	PRODUCT TANKER	49,999	183	1
CABO HELLAS	MHL	PRODUCT TANKER	69,636	228	2
CALIFORNIA VOYAGER	USA	CHEMICAL/OIL TANKER	45,671	183	6
CALYPSO	LBR	CHEMICAL/OIL TANKER	46,190	183	1
CAP VICTOR	GRC	CRUDE OIL TANKER	158,853	274	1
CAPE TALLIN	MHL	CHEMICAL/OIL TANKER	73,662	229	2
CAPELLA	USA	TANK BARGE	11,434	101	7
CAPRICORN VOYAGER	BHS	CRUDE OIL TANKER	104,611	244	15
CASCADE SPIRIT	BHS	CRUDE OIL TANKER	156,853	274	1
CASTOR VOYAGER	BHS	CRUDE OIL TANKER	104,866	244	10
CELTIC SEA	LBR	CRUDE OIL TANKER	90,435	239	3



## Appendix G

NAME	FLAG	Type	DWT	LOA	Arrivals
CENTER	MLT	CRUDE OIL TANKER	156,516	274	3
CHAMPION CORNELIA	NOR	PRODUCT TANKER	44,999	183	3
CHAMPION EXPRESS	LBR	CHEMICAL TANKER	43,157	192	1
CHAMPION TERN	NIS	CHEMICAL/OIL TANKER	47,363	182	1
CHAMPION TIDE	NIS	CHEMICAL/OIL TANKER	40,727	181	2
CHAMPION TRADER	LBR	CHEMICAL/OIL TANKER	40,727	189	1
CHAMPION TRUST	NOR	CHEMICAL/OIL TANKER	39,999	181	2
CHANTAL	LBR	PRODUCT TANKER	74,329	228	5
CHEMBULK BARCELONA	SGP	CHEMICAL TANKER	32,345	174	2
CHEMBULK MINNEAPOLIS	PAN	CHEMICAL/OIL TANKER	33,682	170	1
CHEMBULK VIRGIN GORDA	SGP	CHEMICAL/OIL TANKER	34,614	170	1
CHEMICAL AQUARIUS	HKG	CHEMICAL TANKER	18,044	142	2
CHERRY GALAXY	PAN	CHEMICAL/OIL TANKER	19,364	147	2
CLAXTON BAY	HKG	CHEMICAL TANKER	36,400	182	2
CLIPPER SKY	NIS	LIQUID GAS CARRIER	44,617	205	1
COMMANDER	LBR	CRUDE OIL TANKER	49,995	228	1
COMMENCEMENT BAY	USA	TANK BARGE	15,242	114	20
CONFIDENCE	LBR	CRUDE OIL TANKER	71,024	228	4
CYPRESS GALAXY	PAN	CHEMICAL/OIL TANKER	19,998	148	5
DA YUAN HU	CHN	CRUDE OIL TANKER	159,149	275	2
DBL 106	USA	ARTICULATED OTB	13,969	122	1
DBL 140	USA	ARTICULATED OTB	19,992	145	6
DBL 185	USA	ARTICULATED OTB	27,083	176	10
DBL 77	USA	ARTICULATED OTB	11,000	103	8
DENEB	USA	TANK BARGE	11,931	103	11
DENSA ORCA	MHL	NON SPECIFIC TANKER	158,322	274	2
DESPINA	GRC	PRODUCT TANKER	59,988	229	1
DEVON	GRC	CRUDE OIL TANKER	157,642	275	1
DHT SOPHIE	MHL	CRUDE OIL TANKER	112,045	250	2
DIAMOND ORCHID	SGP	CHEMICAL TANKER	19,702	144	1
DONG-A KRIOS	PAN	PRODUCT TANKER	49,997	183	1
DONG-A TRITON	PAN	PRODUCT TANKER	49,997	183	3

## Appendix G

NAME	FLAG	Type	DWT	LOA	Arrivals
DORIC BREEZE	LBR	PRODUCT TANKER	51,565	183	1
DR. ROBERT J. BEALL	USA	ARTICULATED OTB	14,897	404	8
DRAKES BAY	USA	TANK BARGE	12,000	116	13
DS PROMOTER	LBR	CRUDE OIL TANKER	70,392	228	3
DUBAI GLAMOUR	MHL	CRUDE OIL TANKER	115,600	239	3
EAGLE BAY	USA	CRUDE OIL TANKER	114,762	251	6
EL JUNIOR PNT	MHL	PRODUCT TANKER	68,467	229	3
EMMA VICTORY	NIS	CHEMICAL/OIL TANKER	40,727	180	2
ENERGY CHAMPION	IOM	PRODUCT TANKER	70,753	228	2
ENERGY CHANCELLOR	IOM	PRODUCT TANKER	70,558	228	1
ENERGY COMMANDER	IOM	CRUDE OIL TANKER	70,681	228	2
ENERGY PANTHER	IOM	CHEMICAL/OIL TANKER	44,999	183	5
ESER K.	MHL	PRODUCT TANKER	115,277	250	1
ESSIE C	MHL	PRODUCT TANKER	47,000	183	1
EUROPEAN SPIRIT	BHS	CRUDE OIL TANKER	151,848	269	1
FANTASIA	ITA	CHEMICAL/OIL TANKER	51,434	176	1
FIGHT FANCONI ANEMIA	USA	ARTICULATED OTB	6,685	422	3
FINESSE	GRC	CRUDE OIL TANKER	150,709	274	1
FLORIDA VOYAGER	USA	PRODUCT TANKER	46,069	183	2
FORRES PARK	HKG	CHEMICAL/OIL TANKER	47,128	183	1
FPMC 25	LBR	PRODUCT TANKER	50,000	182	1
FRONT ULL	MHL	CRUDE OIL TANKER	157,000	274	1
FSL HONG KONG	SGP	CRUDE OIL TANKER	115,934	250	4
FUJI GALAXY	MHL	CHEMICAL/OIL TANKER	25,000	160	3
GASCHEM BREMEN	LBR	LIQUID GAS CARRIER	28,520	174	6
GENMAR COMPANION	BMU	PRODUCT TANKER	72,768	229	1
GENMAR HARRIET G.	LBR	CRUDE OIL TANKER	150,205	274	1
GEORGIS NIKOLOS	GRC	PRODUCT TANKER	72,341	228	1
GINGA TIGER	PAN	CHEMICAL TANKER	25,452	160	1
GLADIATOR	LBR	CRUDE OIL TANKER	149,944	274	1
GODAVARI SPIRIT	BHS	CRUDE OIL TANKER	159,106	274	1
GOTLAND ALIYA	BHS	PRODUCT TANKER	53,148	183	1

## Appendix G

NAME	FLAG	Type	DWT	LOA	Arrivals
GOTLAND SOFIA	BHS	CHEMICAL/OIL TANKER	53,187	183	1
GRAN COUVA	HKG	CHEMICAL/OIL TANKER	47,128	183	1
GREEN OAK	MHL	CHEMICAL/OIL TANKER	13,282	129	1
GULF JUMEIRAH	BHS	CHEMICAL/OIL TANKER	46,913	183	1
GULF RASTAQ	BHS	CHEMICAL/OIL TANKER	46,544	183	1
GULF STREAM	BHS	PRODUCT TANKER	74,999	228	4
HAFNIA CRUX	DIS	CHEMICAL/OIL TANKER	52,550	183	2
HARBOUR FASHION	PMD	CHEMICAL TANKER	16,878	144	1
HARUNA EXPRESS	HKG	PRODUCT TANKER	45,761	180	1
HELLESPONT PRIDE	MHL	PRODUCT TANKER	73,727	229	2
HELLESPONT PROMISE	LBR	PRODUCT TANKER	73,669	229	2
HELLESPONT PROTECTOR	LBR	PRODUCT TANKER	73,721	229	1
HERCULES	HKG	CHEMICAL/OIL TANKER	51,218	183	1
HIGH DISCOVERY	MLT	CHEMICAL/OIL TANKER	45,999	183	1
HIGH SEAS	LBR	CHEMICAL/OIL TANKER	51,678	183	1
HUGLI SPRIT	BHS	CHEMICAL/OIL TANKER	46,955	183	1
INCA	CYP	PRODUCT TANKER	68,467	228	2
IPANEMA STREET	LBR	PRODUCT TANKER	47,378	182	1
IVER EXACT	NLD	CHEMICAL/OIL TANKER	46,575	183	1
JASMIN JOY	BHS	CRUDE OIL TANKER	104,604	229	2
KALAMAS	LBR	CRUDE OIL TANKER	105,391	239	3
KAYS POINT	USA	TANK BARGE	9,995	100	1
KERALA	LBR	PRODUCT TANKER	74,999	228	1
KEROS	GRC	PRODUCT TANKER	74,999	228	1
KIRBY 185-01	USA	ARTICULATED OTB	26,655	0	1
LARVIK	BHS	PRODUCT TANKER	61,213	213	2
LEO	USA	TANK BARGE	9,000	97	28
LEO SUN	LBR	CRUDE OIL TANKER	114,531	244	1
LIBERTY BAY	USA	CRUDE OIL TANKER	114,820	251	4
LIME GALAXY	HKG	CHEMICAL TANKER	19,992	146	4
LONDON STAR	LBR	CRUDE OIL TANKER	73,869	229	2
LOVEL BRIERE	USA	TANK BARGE	8,864	0	14

## Appendix G

NAME	FLAG	Type	DWT	LOA	Arrivals
LUGI LAGRANGE	ITA	LIQUID GAS CARRIER	29,190	180	5
LUMEN N	PAN	PRODUCT TANKER	63,599	228	1
LUZON SPIRIT	MHL	CRUDE OIL TANKER	109,581	243	1
MAERSK BELFAST	SGP	CHEMICAL/OIL TANKER	29,031	175	1
MAERSK KIERA	SGP	CHEMICAL/OIL TANKER	39,724	183	1
MAERSK MARMARA	SGP	CHEMICAL/OIL TANKER	51,182	183	1
MAERSK MESSINA	SGP	PRODUCT TANKER	48,056	180	1
MAERSK MIYAJIMA	PAN	PRODUCT TANKER	12,680	180	1
MAHANADI SPIRIT	BHS	CHEMICAL/OIL TANKER	44,996	182	1
MARAN PENELOPE	GRC	CRUDE OIL TANKER	158,267	274	1
MARAN POSEIDON	GRC	CRUDE OIL TANKER	129,221	274	1
MARE DI GENOVA	ITA	CHEMICAL/OIL TANKER	51,371	183	2
MARIA PRINCESS	LBR	CRUDE OIL TANKER	105,346	229	1
MARITINA	NIS	PRODUCT TANKER	74,993	228	1
MAYA	CYP	PRODUCT TANKER	68,500	228	4
MEGACORE PHILOMENA	MHL	PRODUCT TANKER	74,574	228	1
MINDORO STAR	MHL	PRODUCT TANKER	73,677	229	1
MINERVA SYMPHONY	GRC	CRUDE OIL TANKER	159,450	277	1
MISS BENEDETTA	MLT	CHEMICAL/OIL TANKER	50,825	183	1
MISS MARIA ROSARIA	MLT	CHEMICAL/OIL TANKER	50,895	183	1
MISSISSIPPI VOYAGER	USA	PRODUCT TANKER	46,094	183	23
MONTEREY BAY	USA	TANK BARGE	14,589	116	26
MONTESTENA	PMD	CRUDE OIL TANKER	159,372	274	1
MORRO BAY	USA	TANK BARGE	14,589	117	24
MOUNT KIBO	LBR	CHEMICAL/OIL TANKER	37,843	184	1
NAVE CETUS	LBR	PRODUCT TANKER	74,581	228	1
NAVE DORADO	PAN	PRODUCT TANKER	47,999	180	1
NAVE EQUATOR	MLT	CHEMICAL/OIL TANKER	50,542	183	4
NAVE LUCIDA	PAN	PRODUCT TANKER	47,999	180	1
NAVE ORION	PAN	CHEMICAL/OIL TANKER	49,999	183	1
NAVE UNIVERSE	MHL	PRODUCT TANKER	45,313	183	1
NAVIG8 AMETHYST	MHL	CHEMICAL TANKER	37,295	183	1

## Appendix G

NAME	FLAG	Type	DWT	LOA	Arrivals
NAVIG8 AQUAMARINE	MHL	PRODUCT TANKER	37,596	184	5
NEW BREEZE	PAN	PRODUCT TANKER	48,064	180	1
NEW CONQUEST	MHL	PRODUCT TANKER	73,917	229	1
NEW CONSTELLATION	MHL	PRODUCT TANKER	73,911	229	2
NICOLAOS	GRC	CRUDE OIL TANKER	164,758	274	1
NINA	ITA	CHEMICAL/OIL TANKER	40,401	180	1
NINA VICTORY	NIS	CHEMICAL/OIL TANKER	40,584	181	2
NISSOS KYTHNOS	GRC	CRUDE OIL TANKER	115,700	250	8
NORD GAINER	DNK	PRODUCT TANKER	50,280	183	2
NORD GUARDIAN	DIS	CHEMICAL/OIL TANKER	50,420	183	3
NORD IMAGINATION	PAN	PRODUCT TANKER	48,006	180	1
NORD OPTIMISER	LBR	PRODUCT TANKER	47,371	182	1
NORD ORGANISER	PAN	PRODUCT TANKER	47,399	182	1
NORD SNOW QUEEN	DNK	CHEMICAL/OIL TANKER	38,289	183	1
NORD STEADY	SGP	PRODUCT TANKER	49,994	183	6
NORDIC OSLO	DNK	CHEMICAL/OIL TANKER	12,975	127	1
NORDIC ZENITH	LBR	CRUDE OIL TANKER	158,645	274	1
NORIENT STAR	MLT	CHEMICAL/OIL TANKER	40,416	180	1
NS SILVER	LBR	CHEMICAL/OIL TANKER	47,197	182	1
OLYMPIC SPIRIT	USA	TANK BARGE	13,366	112	19
OREGON VOYAGER	USA	CHEMICAL/OIL TANKER	45,671	189	42
ORIENT SUNSHINE	PAN	PRODUCT TANKER	45,994	180	1
ORIENTAL EMERALD	PAN	PRODUCT TANKER	50,379	189	1
OVERSEAS ALCMAR	MHL	CHEMICAL/OIL TANKER	45,800	183	1
OVERSEAS ANDROMAR	MHL	CHEMICAL/OIL TANKER	46,195	183	2
OVERSEAS ARIADMAR	MHL	CHEMICAL/OIL TANKER	45,800	183	3
OVERSEAS BOSTON	USA	CHEMICAL/OIL TANKER	46,804	183	4
OVERSEAS GOLDMAR	MHL	PRODUCT TANKER	69,684	228	2
OVERSEAS KIMOLOS	MHL	CHEMICAL/OIL TANKER	51,218	183	1
OVERSEAS KYTHNOS	MHL	CHEMICAL/OIL TANKER	50,000	183	3
OVERSEAS LEYTE	MHL	PRODUCT TANKER	74,192	229	4
OVERSEAS LOS ANGELES	USA	PRODUCT TANKER	46,817	183	27

## Appendix G

NAME	FLAG	Type	DWT	LOA	Arrivals
OVERSEAS LUZON	MHL	PRODUCT TANKER	74,908	228	2
OVERSEAS MARTINEZ	USA	CHEMICAL/OIL TANKER	46,653	183	6
OVERSEAS NIKISKI	USA	PRODUCT TANKER	45,760	183	9
OVERSEAS PEARLMAR	MHL	CRUDE OIL TANKER	69,250	219	2
OVERSEAS ROSEMAR	MHL	CRUDE OIL TANKER	70,000	32	1
OVERSEAS SAMAR	MHL	CHEMICAL/OIL TANKER	74,192	229	1
OVERSEAS SILVERMAR	MHL	PRODUCT TANKER	69,609	228	2
OVERSEAS VISAYAS	MHL	PRODUCT TANKER	74,933	228	1
PACIFIC BRIDGE	MHL	CRUDE OIL TANKER	105,579	239	1
PACIFIC DAWN	PAN	CRUDE OIL TANKER	105,699	239	1
PAMISOS	LBR	CRUDE OIL TANKER	105,335	229	1
PARAMOUNT HYDRA	IOM	CRUDE OIL TANKER	113,968	250	3
PECOS	MHL	CRUDE OIL TANKER	158,465	274	2
PEGASUS VOYAGER	BHS	CRUDE OIL TANKER	156,000	276	30
PICHINCHA	PAN	CRUDE OIL TANKER	91,108	244	2
PINE GALAXY	BHS	CHEMICAL/OIL TANKER	19,997	148	4
PINNACLE SPIRIT	BHS	CRUDE OIL TANKER	160,391	274	1
POLAR ADVENTURE	USA	CRUDE OIL TANKER	141,740	272	6
POLAR DISCOVERY	USA	CRUDE OIL TANKER	141,740	272	11
POLAR ENDEAVOUR	USA	CRUDE OIL TANKER	141,740	273	5
POLAR ENTERPRISE	USA	CRUDE OIL TANKER	141,740	273	14
POLAR RESOLUTION	USA	CRUDE OIL TANKER	140,320	273	8
POLARIS VOYAGER	BHS	CRUDE OIL TANKER	156,000	276	44
POLYAIGOS	GRC	CRUDE OIL TANKER	69,510	228	5
PRINCIMAR PROMISE	MHL	CRUDE OIL TANKER	158,700	274	4
PUDU	CHL	CHEMICAL/OIL TANKER	51,215	183	2
RADIANT SEA	MHL	CRUDE OIL TANKER	73,933	229	3
RELIANCE II	SGP	CHEMICAL/OIL TANKER	46,108	183	1
RIDGEBURY JULIA M	MHL	PRODUCT TANKER	45,980	180	1
RIDGEBURY ROSEMARY E	MHL	CHEMICAL/OIL TANKER	50,261	183	1
SAKURA EXPRESS	HKG	PRODUCT TANKER	45,718	180	1
SAMOS	BHS	CRUDE OIL TANKER	104,649	229	3

## Appendix G

NAME	FLAG	Type	DWT	LOA	Arrivals
SASANOVA	USA	TANK BARGE	7,343	101	1
SCF PEARL	LBR	PRODUCT TANKER	74,552	228	3
SCF TOMSK	LBR	LIQUID GAS CARRIER	26,424	174	1
SEA HERMES	MLT	PRODUCT TANKER	45,879	180	1
SEBAROK SPIRIT	BHS	CRUDE OIL TANKER	95,649	246	1
SEXTANS	HKG	CHEMICAL/OIL TANKER	51,215	173	1
SHANGHAI DAWN	PAN	CRUDE OIL TANKER	111,410	246	1
SHARON SEA	LBR	PRODUCT TANKER	73,870	229	2
SIERRA	USA	CRUDE OIL TANKER	124,777	264	5
SILVER CINDY	MHL	PRODUCT TANKER	52,000	183	1
SILVER EMILY	MHL	CHEMICAL/OIL TANKER	52,000	183	1
SILVER GINNY	MHL	PRODUCT TANKER	49,746	183	2
SILVER GWEN	PAN	PRODUCT TANKER	49,780	183	1
SILVER HAGUE	PAN	PRODUCT TANKER	49,780	183	1
SILVER HOUSTON	PAN	PRODUCT TANKER	49,780	183	1
SINGAPORE VOYAGER	SGP	CRUDE OIL TANKER	105,850	240	2
SITEAM ADVENTURER	BMU	CHEMICAL/OIL TANKER	46,099	183	1
SITEAM LEADER	SGP	CHEMICAL/OIL TANKER	46,190	183	1
SIVA ROTTERDAM	PAN	CHEMICAL TANKER	19,995	146	1
SIXTY FIVE ROSES	USA	TANK BARGE	13,770	123	15
SKOPELOS	GRC	PRODUCT TANKER	70,146	228	1
SONANGOL CABINDA	BHS	CRUDE OIL TANKER	157,748	274	1
SONANGOL KALANDULA	BHS	CRUDE OIL TANKER	157,955	274	1
SONGA BREEZE	MHL	CHEMICAL TANKER	19,999	147	1
SPRUCE GALAXY	SGP	CHEMICAL TANKER	19,995	148	6
STAR FALCON	PAN	PRODUCT TANKER	53,815	186	1
STEALTH II	MHL	PRODUCT TANKER	50,695	183	2
STELLAR LILAC	PAN	CHEMICAL TANKER	12,560	128	6
STENA CONQUEROR	BMU	CHEMICAL TANKER	47,323	182	2
STI AQUA	MHL	CHEMICAL/OIL TANKER	50,300	183	1
STI BROOKLYN	MHL	PRODUCT TANKER	50,175	183	1
STI SOHO	MHL	CHEMICAL/OIL TANKER	50,300	183	2

## Appendix G

NAME	FLAG	Type	DWT	LOA	Arrivals
STI ST CHARLES	MHL	CHEMICAL/OIL TANKER	50,300	183	1
STI VENERE	MHL	CHEMICAL/OIL TANKER	49,990	183	3
STI VILLE	MHL	CHEMICAL/OIL TANKER	49,990	183	1
STI YORKVILLE	MHL	CHEMICAL/OIL TANKER	49,990	183	1
STRILEN	PAN	CHEMICAL TANKER	19,996	150	1
STROFADES	GRC	PRODUCT TANKER	69,509	228	3
SUN PLOEG	CYM	CHEMICAL TANKER	19,976	146	1
SUNSET BAY	USA	TANK BARGE	11,900	132	25
SUSANNE VICTORY	NIS	CHEMICAL/OIL TANKER	48,338	182	1
TAVRICHEKY BRIDGE	LBR	PRODUCT TANKER	46,697	182	1
THEO T.	BHS	CRUDE OIL TANKER	73,021	219	1
TORM ALEXANDRA	SGP	CHEMICAL/OIL TANKER	49,999	183	1
TORM AMALIE	SGP	CHEMICAL/OIL TANKER	49,999	188	2
TORM CECILIE	DIS	CHEMICAL/OIL TANKER	44,999	182	1
TORM GERD	MHL	CHEMICAL/OIL TANKER	46,317	183	2
TORM GERTRUD	MHL	CHEMICAL/OIL TANKER	46,362	183	3
TOURAINÉ	HKG	LIQUID GAS CARRIER	30,309	196	1
UNITED BANNER	GRC	PRODUCT TANKER	73,635	229	1
UNITED CARRIER	GRC	PRODUCT TANKER	73,675	229	4
VALLE BIANCA	ITA	CHEMICAL/OIL TANKER	50,633	183	2
VALROSSA	ITA	CHEMICAL/OIL TANKER	50,633	183	1
VELEBIT	HRV	CHEMICAL/OIL TANKER	52,554	195	1
VINJERAC	HRV	CHEMICAL/OIL TANKER	51,935	195	1
YASA GOLDEN BOSPHORUS	MHL	CRUDE OIL TANKER	115,867	249	4
YASA GOLDEN HORN	MHL	CRUDE OIL TANKER	116,095	249	8
ZAO GALAXY	MHL	CHEMICAL/OIL TANKER	26,198	159	4
ZARUMA	PAN	CRUDE OIL TANKER	105,310	244	7
ZEFYROS	PAN	CHEMICAL/OIL TANKER	50,155	183	1



## **Appendix H**

### **Recommendations for conducting Escort Training on San Francisco Bay**

#### **1.0 OVERVIEW**

At the inception of Escort Regulations tractor tugs were just beginning to be introduced in San Francisco Bay. Many of the maneuvers that a tractor tug could perform to help reduce speed or steer a tanker were innovative. As tractor tugs have become the dominant escorting tug these maneuvers have become common practice among all escorts and now are incorporated during normal assists performed on tankers and non-tank vessels. For example arresting maneuvers to reduce speeds are practiced on many container ships entering the port of Oakland. The training that in the past would require a full-blown drill is now accomplished during everyday operations.

In addition to on the water training, companies are making extensive use of simulators to address training in their Safety Management Systems. Often this training will incorporate all other industry segments so that there are pilots, vessel operators, and tug crew in the simulator training together. Most facilities have dual simulators so that a tug operator can be in one simulator working with the pilot and the vessel crew in the other simulator. Industry has made use of these facilities to simulate tug/vessel interactions in common navigational areas and also made use of them to simulate interactions at terminals only in the design stage.

Training will continue to play a critical role in safe transits through San Francisco Bay.

#### **2.0 PURPOSE**

To outline and define the process by which pilots, escort tug and ship crews can arrange for and participate in live escort training exercises. This process will enable training to be conducted under agreed upon conditions to promote the safety of all involved. This training process will allow opportunities for demonstration, practice and skill enhancement for emergency response maneuvers. Lessons learned and best practices developed during these training sessions should be shared between the participants.

#### **3.0 SCOPE**

These voluntary recommendations are for the use of all pilots and tug crews actively offering their services as escorts in the Bay. By extension, the users of the services, the escorted vessel crews will also be included in the scope of these recommendations.

## **Appendix H**

### **4.0 RESPONSIBILITIES AND AUTHORITIES**

The pilot, tug captain and ship master have the responsibility to evaluate prior to each training session if it is appropriate to conduct training under the current environmental conditions, which maneuvers are to be demonstrated, where the training will be conducted and at what speed. If all three parties cannot agree, the training will not proceed.

### **5.0 SCHEDULING EXERCISES**

It is intended that these training exercises may be conducted when weather conditions and / or vessel scheduling allows. It is expected that the pilot will initiate the request to conduct these exercises, however the shipmaster or escort tug captain may initiate them. Each may decline to participate with no negative consequences should he or she feel that it is inappropriate.

Tug escort captains and / or mates qualified to conduct escort operations are to be pre-authorized by their companies to make the decision on board if requested by the pilot.

Prior to agreeing to conduct the training, the participants should consider weather, sea conditions, the degree of training of the participants, the speed of the escorted vessel and the maneuvers to be executed. Only when all parties agree that it is appropriate will the training proceed. Each party may also halt the training exercise if he or she becomes concerned for any reason.

### **6.0 TRAINING EXERCISES**

When a training exercise is agreed to, the pilot and tug operator should carefully discuss the maneuvers that they want to demonstrate. The tug operator should be the one to specify at what speeds he will be comfortable performing the maneuvers in question based on his personal experience level and training.

### **7.0 ESCORT LANGUAGE**

In order to work towards a stronger bridge team, this training will encourage all participants to use a standardized tug command language.

### **8.0 CROSS DECK TRAINING**

The San Francisco Bar Pilots, the Chevron Pilots and the independent pilots of the Bay recognize the benefit of understanding how the tug crews operate their vessels during an escort. Towards that end the pilots will be encouraged to ride on board a tug during an escort.

## **Appendix H**

### **9.0 TRIALS / TRAINING INFORMATION**

The participants recognize that less than perfect performance may occur as part of this training process. Further, as new employees are brought on board this learning-by-doing process will continue into the future.

The participants shall not use the outcome of other organization's exercises as part of their own commercial activities. It will be acceptable to discuss one's own organization's training activities as part of your advertising if desired.

These guidelines anticipated live escort training exercises; however, few opportunities arise for on-water exercises involving tankers and tugs, with few individuals trained for emergency events. With maritime simulators becoming more sophisticated in their ability to replicate a variety of situations and with a California Maritime Academy simulator operational, the HSC found simulating local conditions to be a cost-effective alternative to on-water exercises.

The Tugs Work Group concluded that in addition to promoting simulator training for tugs escorting tankers, simulator training is applicable to tugs assisting and docking container ships, bulk carriers and chemical ships – thus providing industry-wide benefits for safe navigation.

The HSC recommends the use of simulators to improve communication between pilots and tug masters, offer in-house training to tug industry personnel, and provide valuable “lessons learned” for emergency situations in a controlled environment.

## Appendix I

# Sites of San Francisco Bay PORTS Stations (Physical Oceanographic Real Time System)



## Appendix J

### San Francisco Bay Area Bridges: Characteristics and Construction Projects

Significant bridge projects presently underway in the San Francisco Bay Area:

- The replacement of the east section of the San Francisco-Oakland Bay Bridge between YBI and Oakland is completed. The estimated completion date for the entire project, including removal of the replaced bridge, is 2018. The reasonable needs of navigation are being met during the work. Updates continue via Local Notices to Mariners and Broadcast Notices to Mariners.
- Caltrans is proposing to replace the Hwy 12 Drawbridge across the Sacramento River at Rio Vista with a mid level drawbridge or high level fixed bridge. They are considering 4 alignment alternatives. With the assistance of the SF/Sacramento Corps of Engineers, SF Bar Pilots, ship rides & chart reviews, the Coast Guard has provided navigational clearance requirements for each alignment to ensure the proposed replacement bridge will meet the existing and future navigational needs for the largest vessels on the waterway.
- San Mateo Transit District is continuing their proposal to replace the drawspan of the Dumbarton railroad drawbridge and resume usage of the bridge for commuter and freight rail traffic, sometime after 2013. The Eleventh Coast Guard District is coordinating with the bridge owner and other agencies to ensure the proposed work will not have negative impacts on the reasonable needs of waterway traffic, during or after the proposed work. A Coast Guard Bridge Permit, pursuant to the General Bridge Act of 1946, will be required for the work, and is subject to the provisions of the National Environmental Policy Act.
- The Golden Gate Bridge District is planning to replace the existing maintenance traveler system on the GG Bridge. They are also planning to install a suicide prevention net system on the bridge. Neither activity by the bridge owner is expected to change the navigational clearance provided by the bridge.

## Appendix J

### San Francisco Bay Area Bridges Encountered By Ocean Going Vessels

(For up to date clearance information refer to the latest NOAA chart or the USCG Bridge Section)

<u>BRIDGE NAME AND LOCATION</u>	<u>TYPE</u>	<u>CLEARANCES</u>	
		<u>Horz/Vert MLLW-MHW</u>	
1. <b>Golden Gate Bridge</b> San Francisco Bay	SUS	4028/238-232	
2. <b>San Francisco-Oakland</b> San Francisco Bay, Westerly Reach	SUS		
Span A-B, Pier A		2229/180-174	
		229/223-217	
Span B-C, Pier B		1072/224-218	
		1072/227-221	
Span C-D, Pier C		1079/226-220	
		1079/224-218	
Span D-E, Pier D		2210/224-218	
		2210/181-175	
Span E-YB Isl, Pier E	Fixed	870/176-170	
3. <b>Richmond-San Rafael</b> San Francisco Bay	Fixed		
Main Channel, Center Span		1000/190-185	
		480/173-168	
East Channel, Center Span		970/140-135	
4. <b>Carquinez</b> Carquinez Strait, Vallejo	Fixed		
Upstream Bridge:			
South (left) Span, South Pier		998/141-135	
South (left) Span, North Pier		998/151-145	
North (right) Span, South Pier		1000/152-146	
North (right) Span, North Pier		1000/157-151	
Downstream Bridge:			
South (left) Span, South Pier		1030/140-134	
South (left) Span, North Pier		1030/150-144	
North (right) Span, South Pier		1030/153-147	
North (right) Span, North Pier		1030/158-152	
5. <b>Martinez, Highway Bridge</b> Martinez/Benicia	Fixed	440/141-135	
6. <b>Martinez, Union Pacific RR Bridge</b> Martinez/Benicia,	V/L Raised	291/140-135	
	Lowered	291/75-70	
7. <b>Antioch</b> Antioch, CA – San Joaquin River	Fixed	400/142-138	

## Appendix J

### San Francisco Bay Area Bridges Encountered By Ocean Going Vessels

(For up to date clearance information refer to the latest NOAA chart or the USCG Bridge Section)

<u>BRIDGE NAME AND LOCATION</u>	<u>TYPE</u>	<u>CLEARANCES</u>	
		<u>Horz/Vert</u>	<u>MLLW-MHW</u>
8. <b>Golden Gate Bridge</b> San Francisco Bay	SUS	4028/238-232	
9. <b>San Francisco-Oakland</b> San Francisco Bay, Westerly Reach	SUS		
Span A-B, Pier A		2229/180-174	
Pier B		229/223-217	
Span B-C, Pier B		1072/224-218	
Pier C		1072/227-221	
Span C-D, Pier C		1079/226-220	
Pier D		1079/224-218	
Span D-E, Pier D		2210/224-218	
Pier E		2210/181-175	
Span E-YB Isl, Pier E	Fixed	870/176-170	
10. <b>Richmond-San Rafael</b> San Francisco Bay	Fixed		
Main Channel, Center Span and Right Span	480/173-168	1000/190-185	Left
East Channel, Center Span		970/140-135	
11. <b>Carquinez</b> Carquinez Strait, Vallejo	Fixed		
Upstream Bridge:			
South (left) Span, South Pier		998/141-135	
South (left) Span, North Pier		998/151-145	
North (right) Span, South Pier		1000/152-146	
North (right) Span, North Pier		1000/157-151	
Downstream Bridge:			
South (left) Span, South Pier		1030/140-134	
South (left) Span, North Pier		1030/150-144	
North (right) Span, South Pier		1030/153-147	
North (right) Span, North Pier		1030/158-152	
12. <b>Martinez, Highway Bridge</b> Martinez/Benicia	Fixed	440/141-135	
13. <b>Martinez, Union Pacific RR Bridge</b> Martinez/Benicia,	V/L Raised Lowered	291/140-135 291/75-70	

## Appendix K

### Sector San Francisco - Port Safety Statistics: 2015

Total Reported Marine Casualties By Type/Month for 2015 - Chart 1														
	Jan	Feb	Mar	Apr	May	Jun	Jul	Aug	Sep	Oct	Nov	Dec	Total	Avg per month
Allision / Collision	0	0	0	1	1	1	0	1	0	0	0	1	5	0.4
Fire	0	1	0	0	0	0	0	1	0	0	0	1	3	0.3
Groundings / Sinkings	1	0	0	0	1	1	0	0	0	0	0	0	3	0.3
Steering	2	0	2	3	0	1	0	1	0	1	0	0	10	0.8
Propulsion / Power	10	4	2	1	3	1	4	5	6	4	2	1	43	3.6
Personnel	0	0	0	0	1	0	0	0	0	0	0	2	3	0.3
Other/Capsize	3	1	3	3	5	0	3	2	2	2	1	3	28	2.3
<b>Total</b>	<b>16</b>	<b>6</b>	<b>7</b>	<b>8</b>	<b>11</b>	<b>4</b>	<b>7</b>	<b>10</b>	<b>8</b>	<b>7</b>	<b>3</b>	<b>8</b>	<b>95</b>	<b>7.9</b>

Total Letters of Deviation (LODs) Issues Due to Navigational Deficiencies/Month for 2015 - Chart 2														
	Jan	Feb	Mar	Apr	May	Jun	Jul	Aug	Sep	Oct	Nov	Dec	Total	Avg per month
Radar	1	1	0	0	0	3	0	1	0	0	0	2	8	0.7
Gyro Compass	0	0	1	2	2	0	0	0	1	0	0	0	6	0.5
Steering	0	0	0	0	0	0	0	0	0	0	0	0	0	0.0
Echo Depth Sounder	0	0	0	0	0	0	0	1	0	0	1	0	2	0.2
AIS	0	0	1	1	2	0	1	0	1	0	0	0	6	0.5
AIS-835	0	2	0	7	6	0	0	0	0	5	1	8	29	2.4
ARPA	0	0	0	0	0	0	0	0	0	0	0	0	0	0.0
Speed Log	3	0	2	2	3	0	1	0	0	0	0	0	11	0.9
R.C.	0	0	0	0	0	0	0	0	0	0	0	0	0	0.0
Other	0	0	2	2	2	1	0	1	0	0	0	0	8	0.7
<b>Total</b>	<b>4</b>	<b>3</b>	<b>6</b>	<b>14</b>	<b>15</b>	<b>4</b>	<b>2</b>	<b>3</b>	<b>2</b>	<b>5</b>	<b>2</b>	<b>10</b>	<b>70</b>	<b>5.8</b>

Total Port State Control Detentions/Month for 2015 - Chart 3														
	Jan	Feb	Mar	Apr	May	Jun	Jul	Aug	Sep	Oct	Nov	Dec	Total	Avg per month
SOLAS	2	1	2	2	2	0	2	2	0	2	3	0	18	1.5
STCW	0	0	0	0	0	0	0	0	0	0	0	0	0	0.0
MARPOL	0	0	0	0	0	0	0	0	0	0	1	0	1	0.1
ISM	1	1	0	0	0	0	0	0	0	0	0	0	2	0.2
ISPS	0	0	0	0	0	0	0	0	0	0	0	0	0	0.0
<b>Total</b>	<b>3</b>	<b>2</b>	<b>2</b>	<b>2</b>	<b>2</b>	<b>0</b>	<b>2</b>	<b>2</b>	<b>0</b>	<b>2</b>	<b>4</b>	<b>0</b>	<b>21</b>	<b>1.8</b>



## Appendix K

Total COTP Orders/Month for 2015 - Chart 4														
	Jan	Feb	Mar	Apr	May	Jun	Jul	Aug	Sep	Oct	Nov	Dec	Total	Avg per month
Navigation Safety	4	5	6	2	8	2	4	3	4	3	3	4	48	4.0
Port Safety & Security	0	1	0	0	0	0	0	0	0	0	0	0	1	0.1
ANOA	0	0	0	0	1	0	0	0	0	0	0	0	1	0.1
Total	4	6	6	2	9	2	4	3	4	3	3	4	50	4.2

Total Reported Marine Casualties By Type/Year 2006-2015 - Chart 5												
	2006 Yr	2007 Yr	2008 Yr	2009 Yr	2010 Yr	2011 Yr	2012 Yr*	2013 Yr*	2014 Yr*	2015 Yr*	Total	Avg
Allision / Collision	16	7	10	9	11	7	11	5	5	5	76	10
Groundings / Sinkings	11	9	4	6	3	4	6	3	3	3	46	6
Fire / Flooding	1	1	1	0	4	0	4	3	3	3	14	2
Propulsion / Power	19	22	14	54	50	66	79	43	43	10	347	43
Steering	6	2	4	3	4	10	10	10	10	43	49	6
Personnel	0	0	0	7	6	1	8	3	3	3	25	3
Other/Capsize	0	0	0	3	6	7	11	28	28	28	55	7

Reported Rule 9 Violations/Month for 2015														
	Jan	Feb	Mar	Apr	May	Jun	Jul	Aug	Sep	Oct	Nov	Dec	Total	Avg per month
Reported Navigation Rule 9 Violations	0	0	1	0	0	2	0	1	0	0	0	0	4	0.62

\* As of October 2012, all casualties occurring in or effecting the HSC jurisdiction are indicated in this report. The apparent increase in almost all casualty categories is likely an artifact of this change in reporting thresholds.

# Appendix K

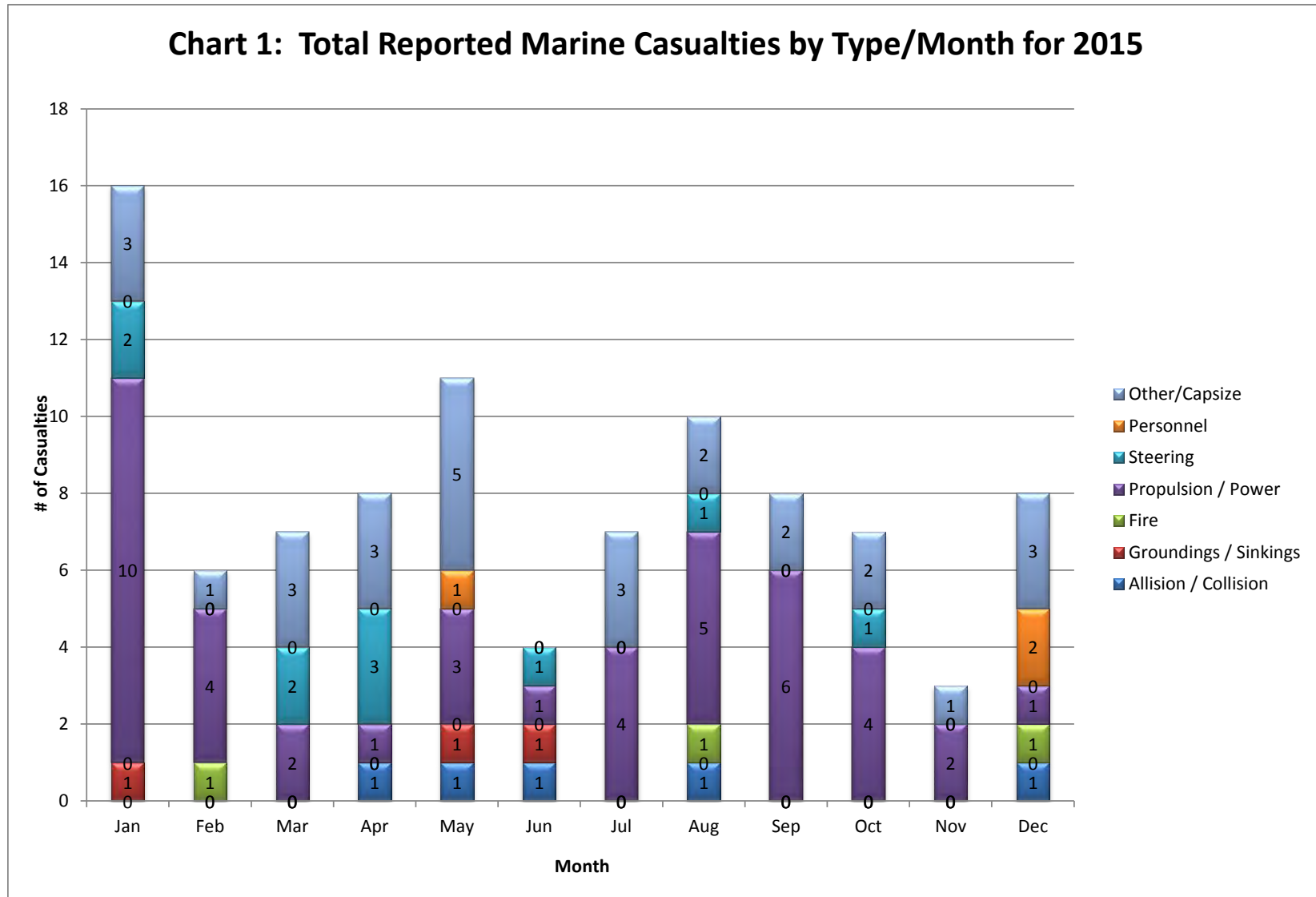

# Appendix K

## Chart 2: Total Letters of Deviation (LODs) Issued Due to Navigational Deficiencies/Month for 2015

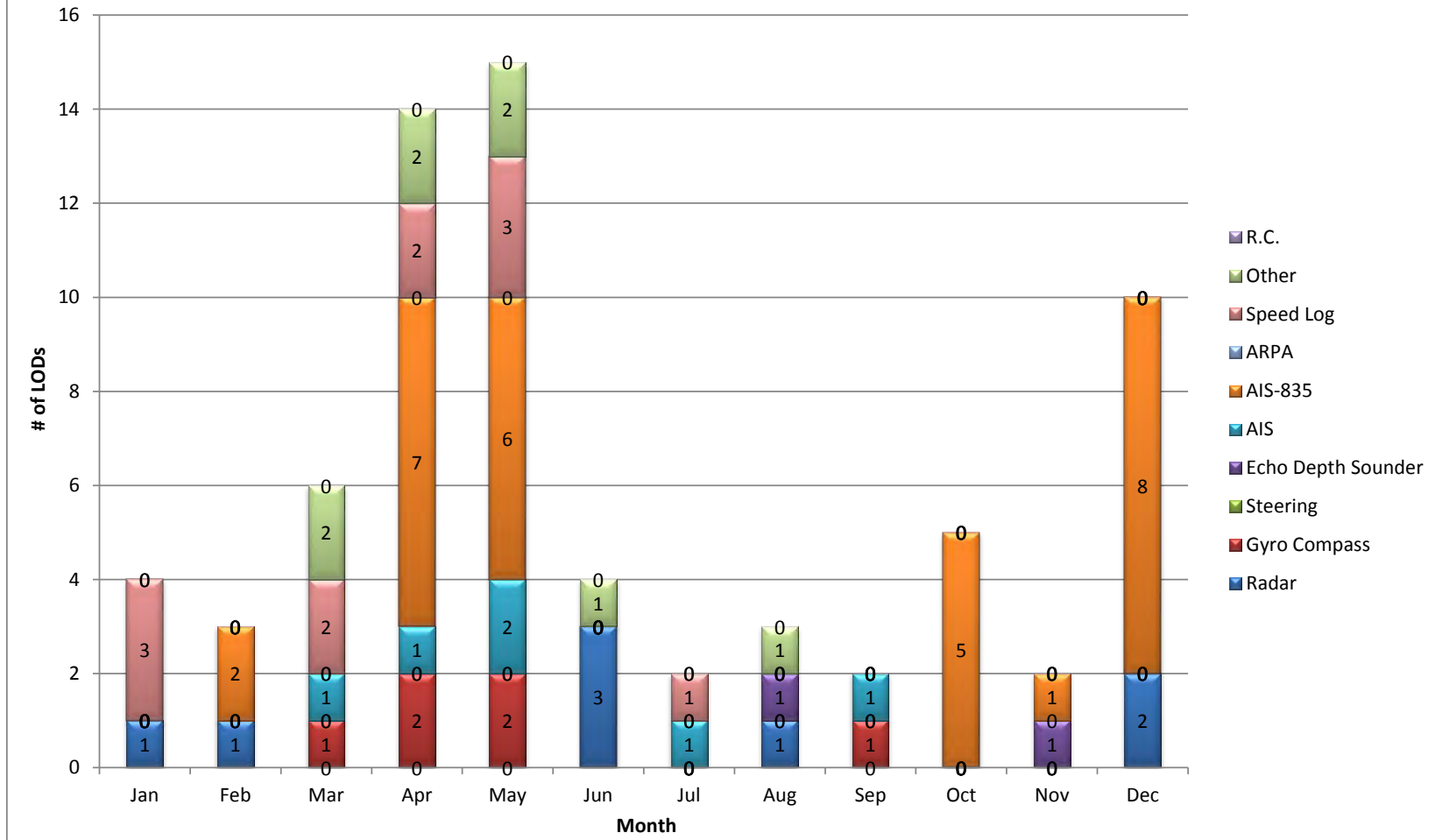

# Appendix K

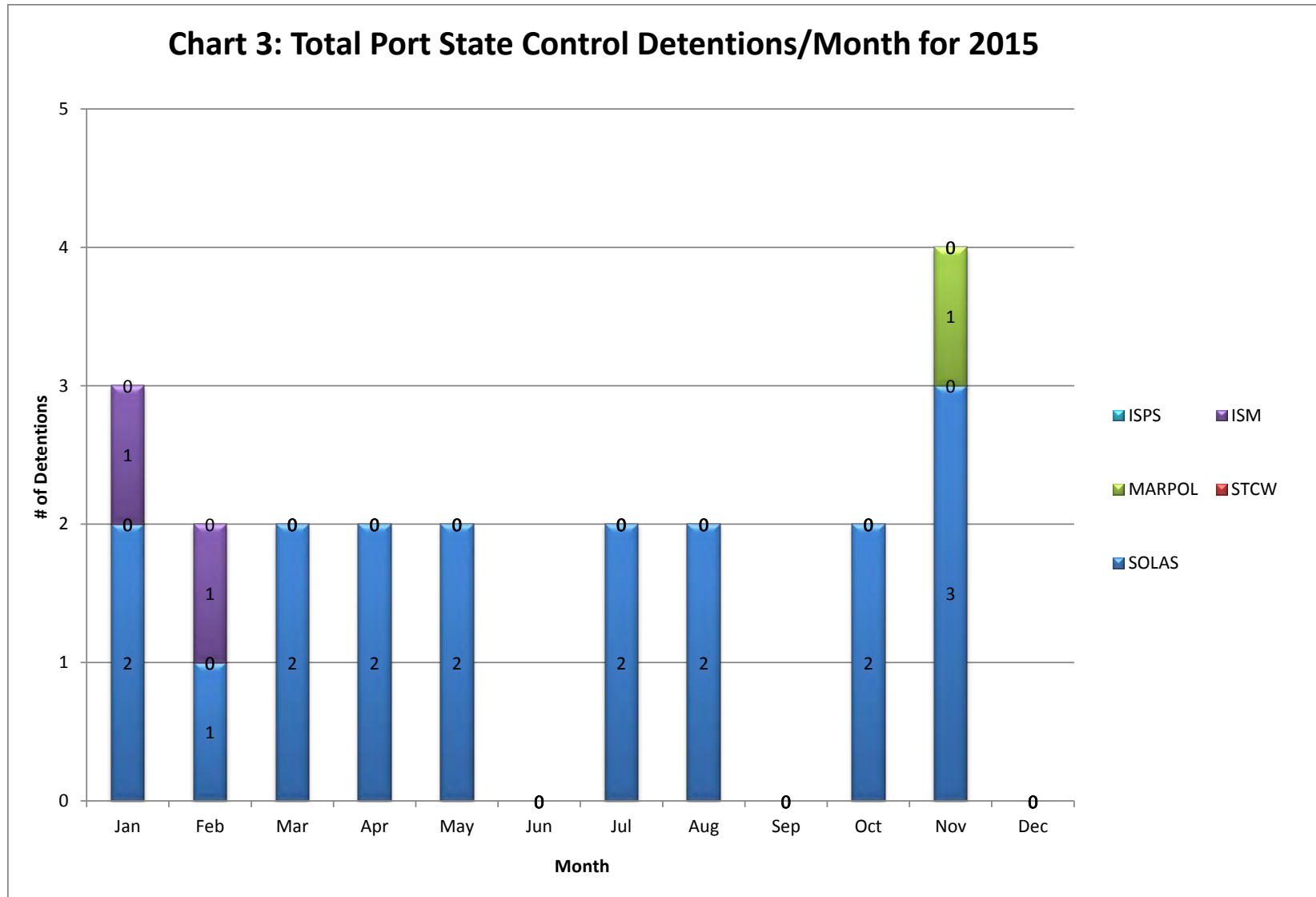

## Appendix K

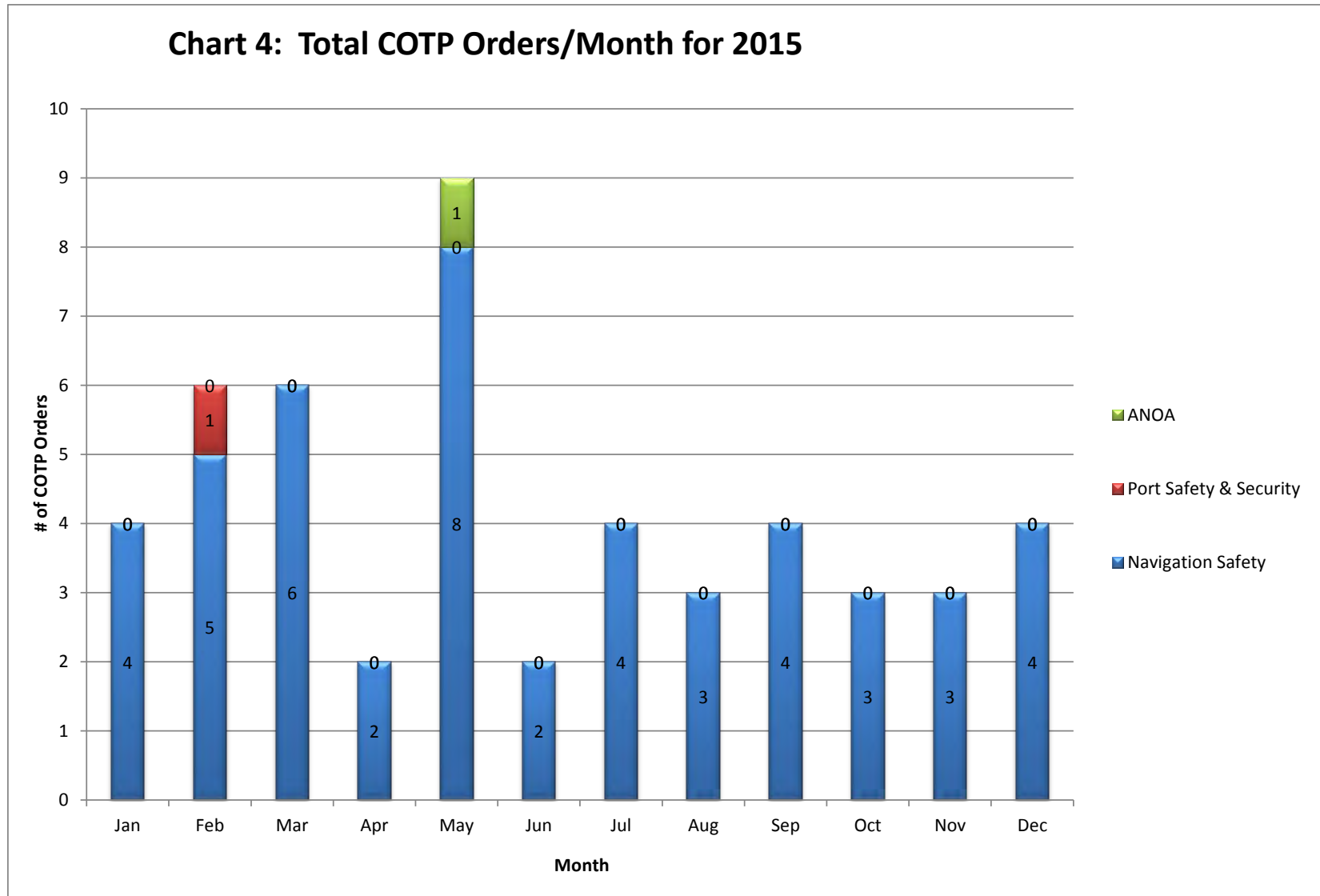

# Appendix K

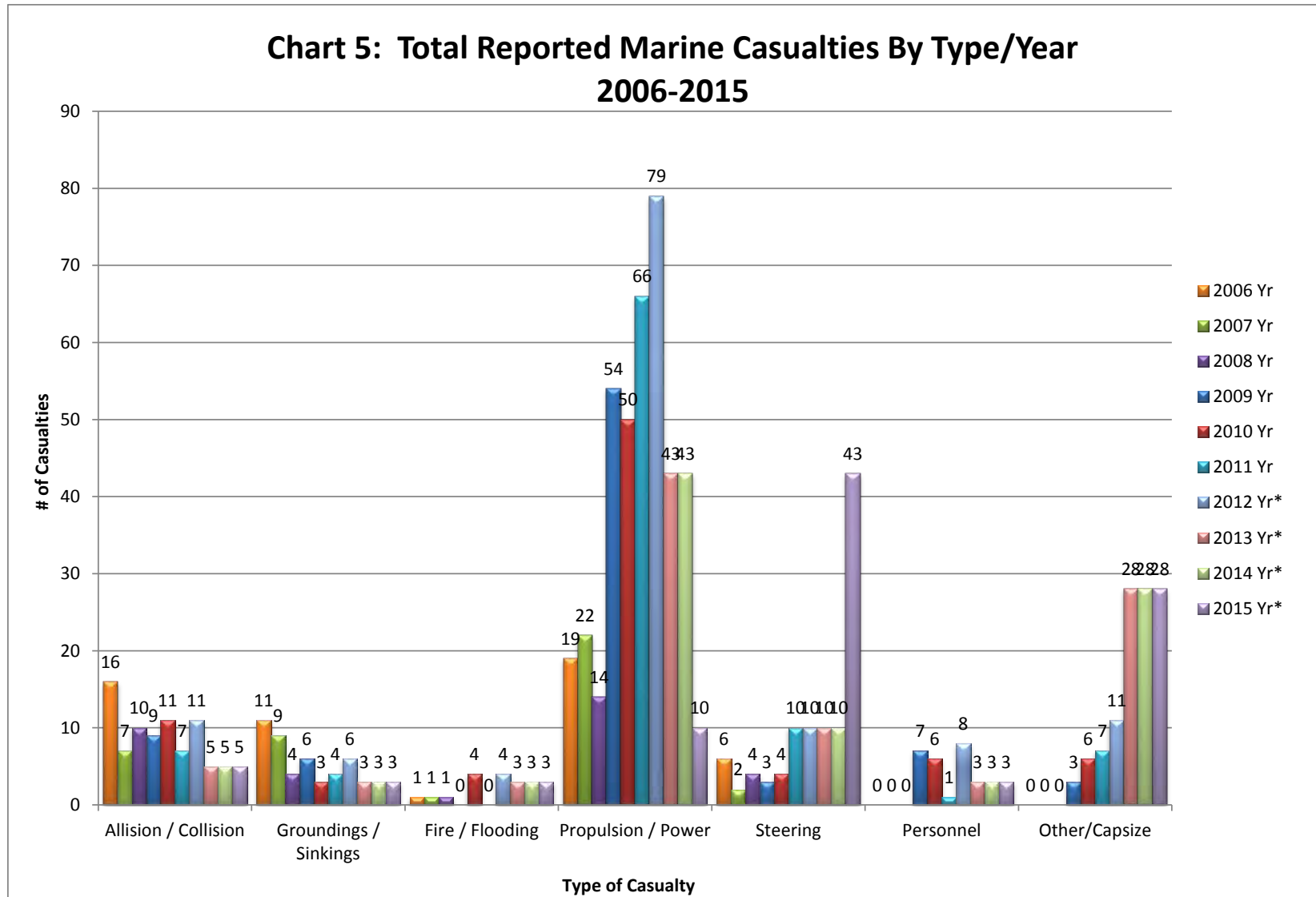

## Appendix L

### Sector San Francisco Pollution Statistics January 1, 2005 to December 31, 2015

**Total Reported Oil Pollution Incidents for Sector SF/Yr - Chart 1**

	2005 Yr	2006 Yr	2007 Yr	2008 Yr	2009 Yr	2010 Yr	2011 Yr	2012 Yr	2013 Yr	2014 yr	2015 yr	Total	Avg
Total Number of Oil Pollution Incidents	200	297	403	502	355	338	115	147	151	187	160	2695	270

**Total Reported Oil Spills by Source/Yr - Chart 2**

	2005 Yr	2006 Yr	2007 Yr	2008 Yr	2009 Yr	2010 Yr	2011 Yr	2012 Yr	2013 Yr	2014 yr	2015 yr	Total	Avg
U.S. Commercial Vessels/ Foreign Freight Vessels	21	35	23	29	23	37	11	24	15	46	266	530	48
Public Vessel	2	15	11	29	8	11	6	25	12	18	17	154	14
Commercial Fishing Vessel	10	20	18	10	13	8	4	32	6	317	16	454	41
Recreational Vessel	59	54	69	74	76	57	24	31	56	180	1111	1791	163
Regulated Waterfront Facilities/Regulated Waterfront Facilities-Fuel Transfer	21	79	118	145	18	117	18	32	2	20	87	657	60
Other Land Source*	0	0	0	0	0	0	0	0	20	1125	44	1189	108
Unknown Source	65	100	160	228	76	108	49	40	40	36	2	904	82

\* = Began tracking Other Land Sources in 2013. Prior to 2013, Other Land Sources were classified under either Unknown Source or Facility/Non-Vessel Source.

**Total Reported Oil Pollution Incidents/Month for 2015 - Chart 3**

	Jan	Feb	Mar	Apr	May	Jun	Jul	Aug	Sep	Oct	Nov	Dec	Total	Avg
Total Number of Oil Pollution Incidents	26	15	16	5	15	3	15	16	12	6	20	11	160	13

	Jan	Feb	Mar	Apr	May	Jun	Jul	Aug	Sep	Oct	Nov	Dec	Total	Avg
Total Amount of Oil Discharged and/or Hazardous Material Released (gallons)	37	86.75	47.56	3	27	305	257	74	575	7	76	47.25	1543	129

**Total Amount of Oil and/or Hazardous Material Released by Vessels/Month for 2015 - Chart 4**

	Jan	Feb	Mar	Apr	May	Jun	Jul	Aug	Sep	Oct	Nov	Dec	Total	Avg
Total Amount of Oil and/or Hazardous Material Released (gallons)	36	0.25	47.06	3	25	305	256	38	573	5	74	47.25	1410	117

## Appendix L

Total Amount of Oil and/or Hazardous Material Released by Non-Vessel Sources/Month for 2015- Chart 5														
	Jan	Feb	Mar	Apr	May	Jun	Jul	Aug	Sep	Oct	Nov	Dec	Total	Avg
Total Amount of Oil and/or Hazardous Material Released (gallons)	1	87	1	0	2	0	1	36	2	2	2	0	133	11

Number of Oil/Hazmat Pollution Incidents /Month for 2015-Chart 6														
	Jan	Feb	Mar	Apr	May	Jun	Jul	Aug	Sep	Oct	Nov	Dec	Total	Avg
# of Spills between 0 - 10 gallons	3	5	7	2	4	1	7	9	6	3	11	5	63	5.3
# of Spills between 10 - 100 gallons	1	1	3	0	1	0	2	3	3	0	3	2	19	1.6
# of Spills between 100 - 1,000 gallons	0	0	0	0	0	1	1	0	1	0	0	0	3	0.3
# of Spills 1,000 gallons >	0	0	0	0	0	0	0	0	0	0	0	0	0	0.0
# of Spills - Unknown size	22	9	6	3	10	1	5	4	2	3	6	4	75	6.3

Total Oil Discharge and/or Hazardous Material Release Volumes By Source (gallons)/Month for 2015 - Chart 7														
	Jan	Feb	Mar	Apr	May	Jun	Jul	Aug	Sep	Oct	Nov	Dec	Total	Avg
U.S. Commercial Vessels/Foreign Freight Vessels	0	0.25	1	0	0	0	252	0	5	0	8	0	266	22.2
Public Vessels	0	0	0	0	0	0	0	10	2	0	5	0.25	17	1.4
Commercial Fishing Vessels	0	0	0.5	0	0	0	1	12	0	0	2	0	16	1.3
Recreational Vessels	36	0	45.5	3	25	305	3	16	566	5	59	47	1111	92.5
Regulated Waterfront Facilities/Regulated Waterfront Facilities-Fuel Transfer	1	84	0	0	0	0	0	0	0	2	0	0	87	7.3
Other Land Sources	0	2.5	0.5	0	2	0	1	36	0	0	2	0	44	3.7
Unknown Source	0	0	0	0	0	0	0	0	2	0	UNK	UNK	2	0.2

Penalty Actions/ Month for 2015														
	Jan	Feb	Mar	Apr	May	Jun	Jul	Aug	Sep	Oct	Nov	Dec	Total	Avg
Civil Penalty Cases for Period	0	0	0	0	0	0	0	0	0	0	0	0	0	0.0
Notice of Violations (TKs)	1	1	1	0	0	1	5	0	0	2	0	0	11	0.9
Letter of Warning (LOW)	2	1	4	2	6	0	1	10	5	1	10	3	45	3.8



## Appendix L

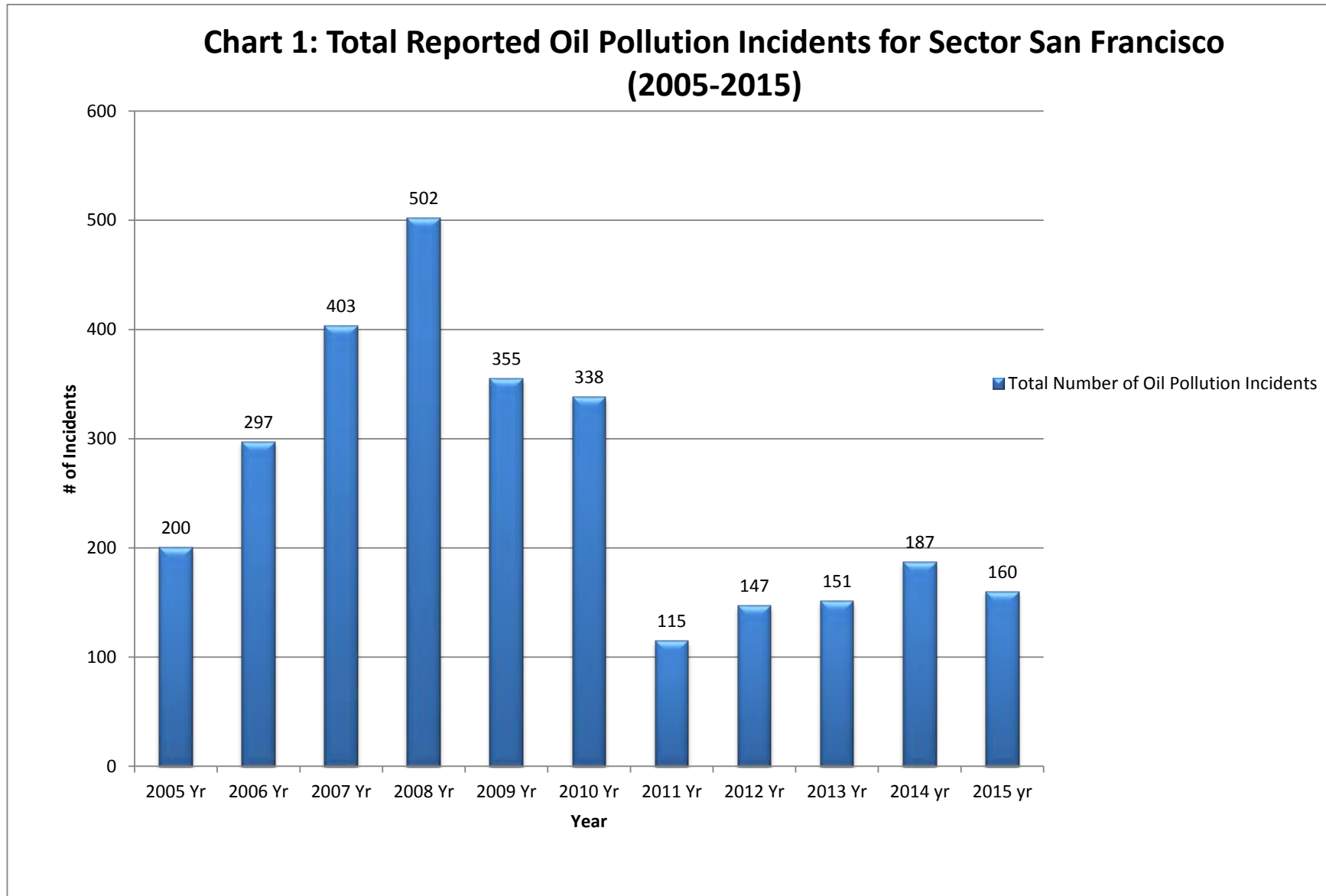

# Appendix L

## Chart 2: Total Reported Oil Spills by Source/Yr (2005-2015)

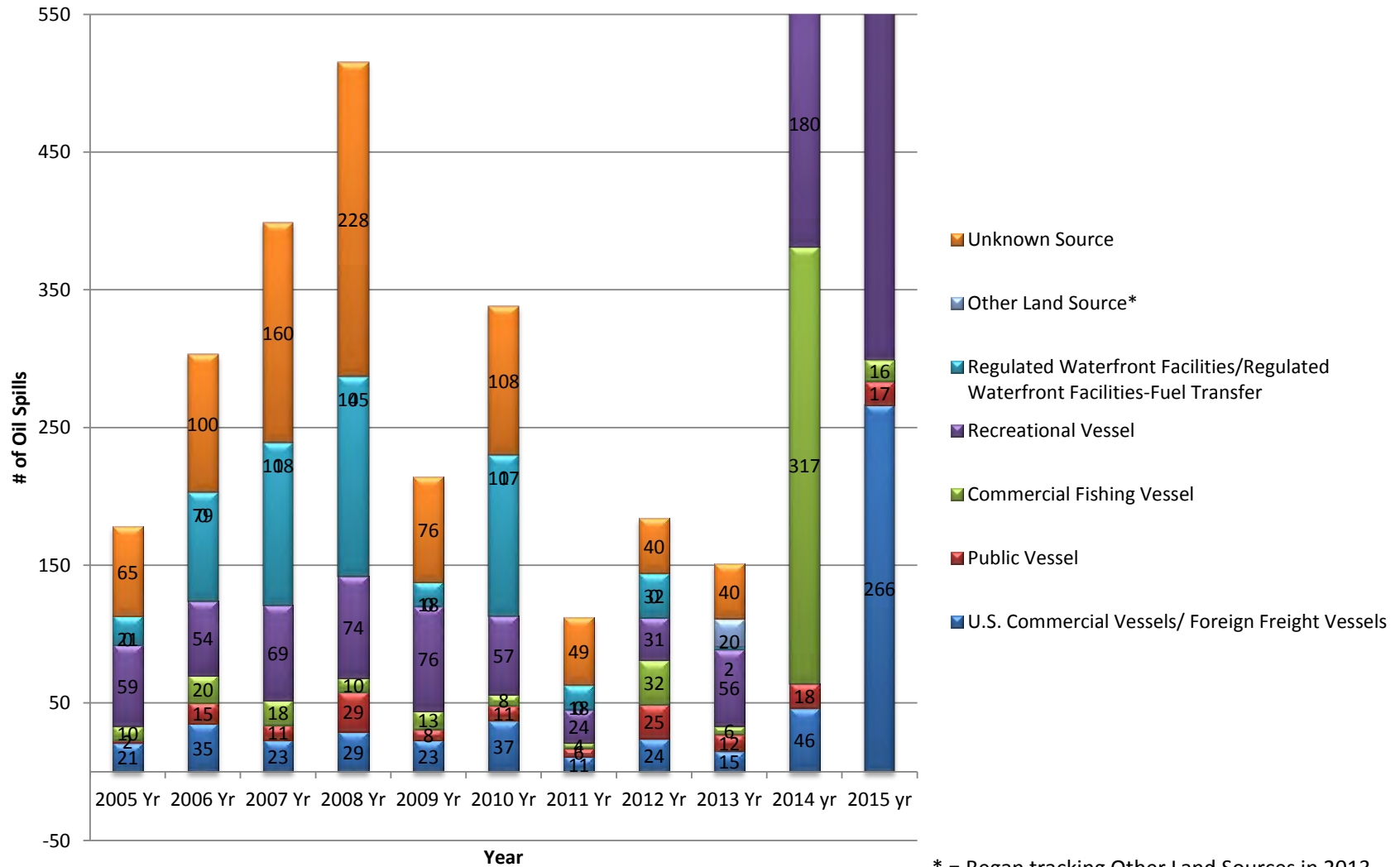

\* = Began tracking Other Land Sources in 2013 .

# Appendix L

## Chart 3: Total Reported Oil Pollution Incidents/Month for 2015

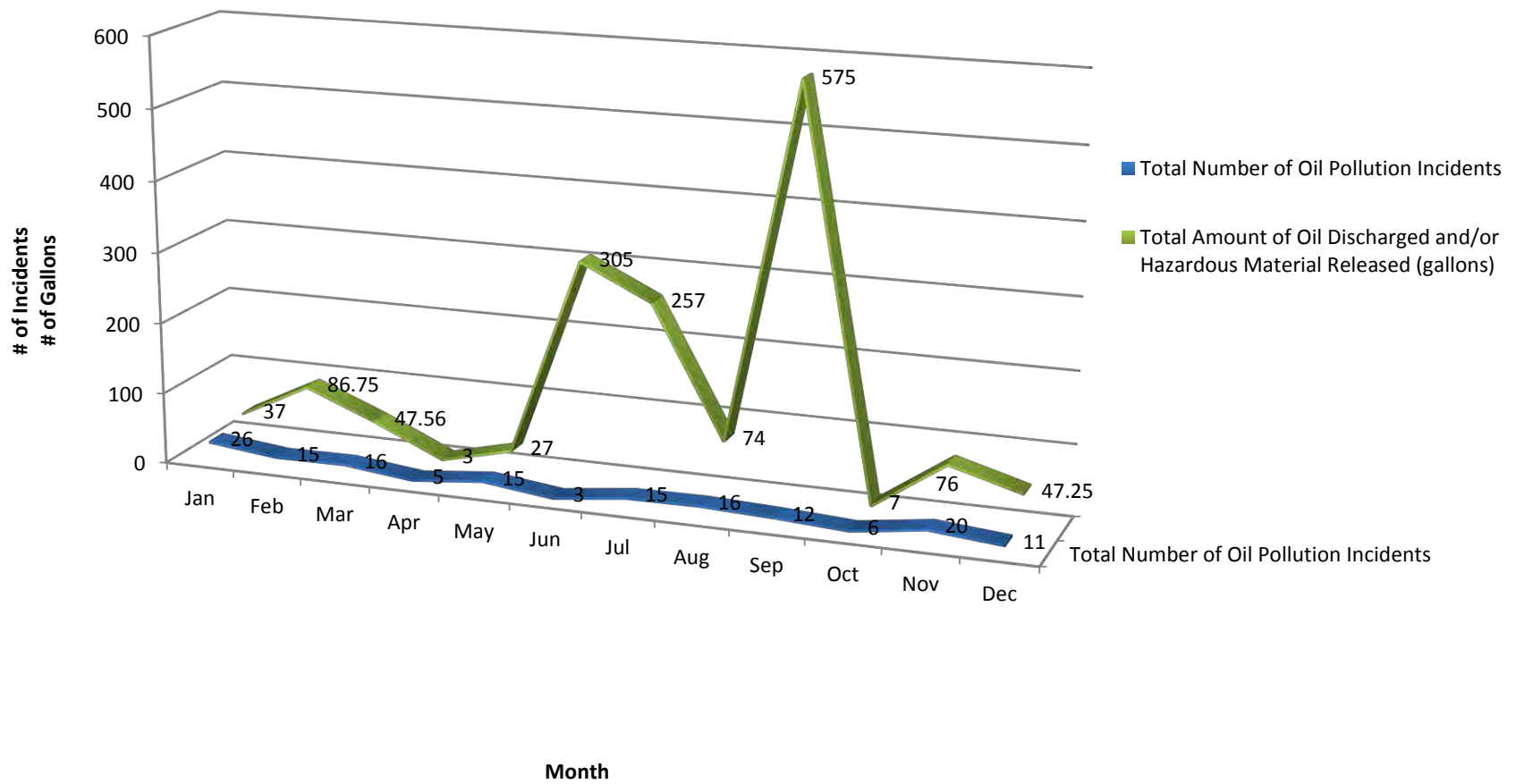

## Appendix L

### Chart 4: Total Amount of Oil and/or Hazardous Material Released By Vessels/Month for 2015 (Gallons)

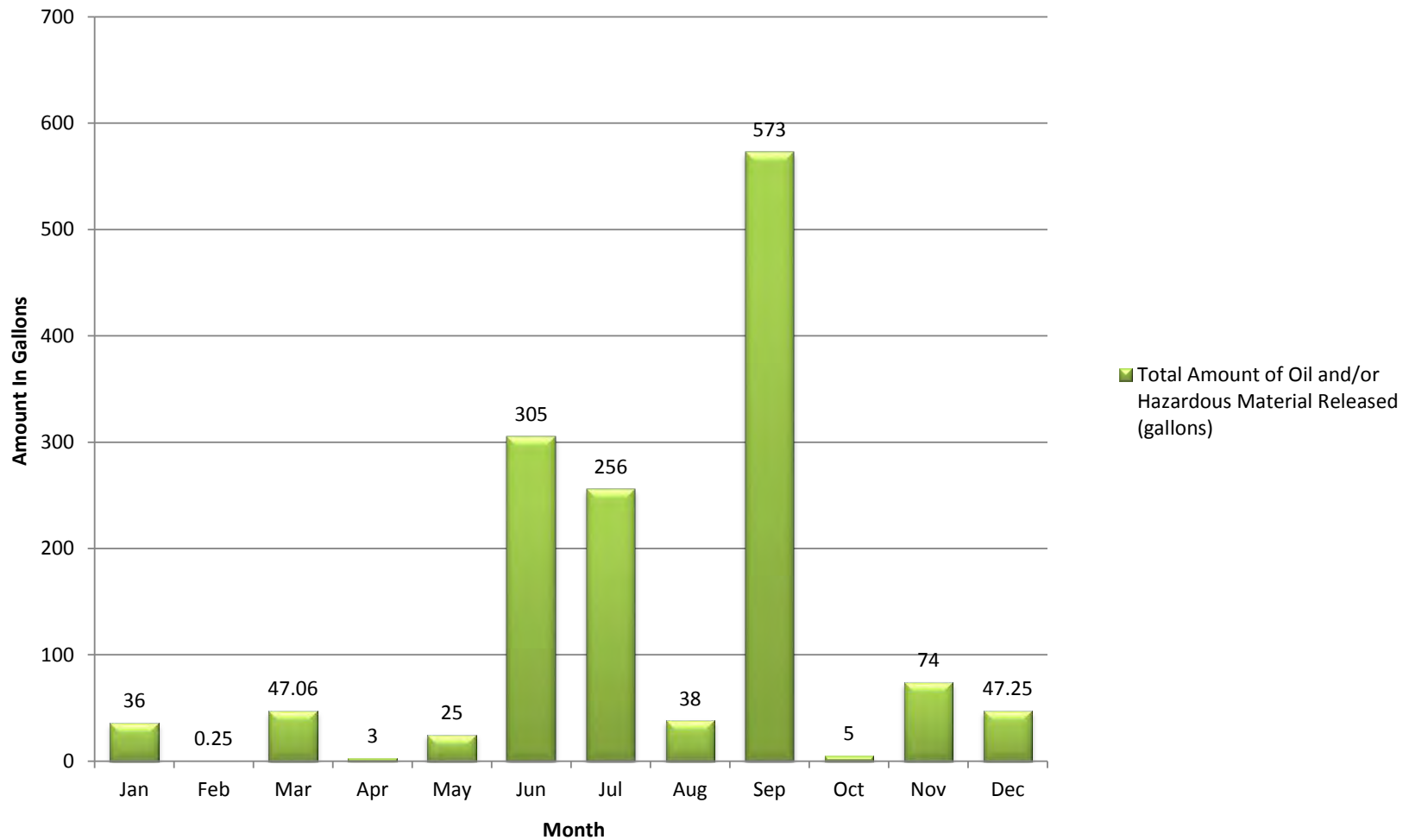

## Appendix L

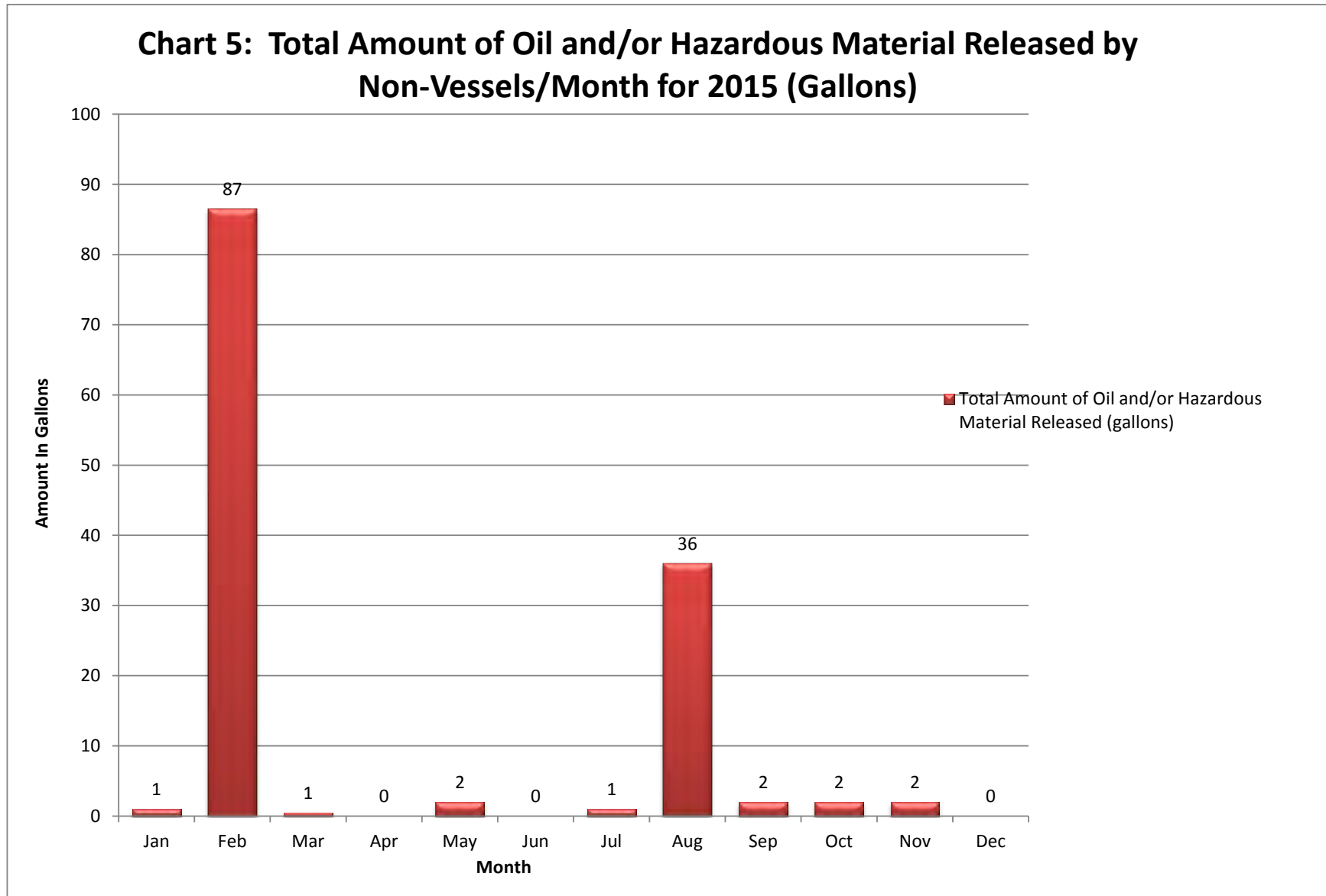

# Appendix L

## Chart 6: Total Reported Oil Spills by Size/Month for 2015

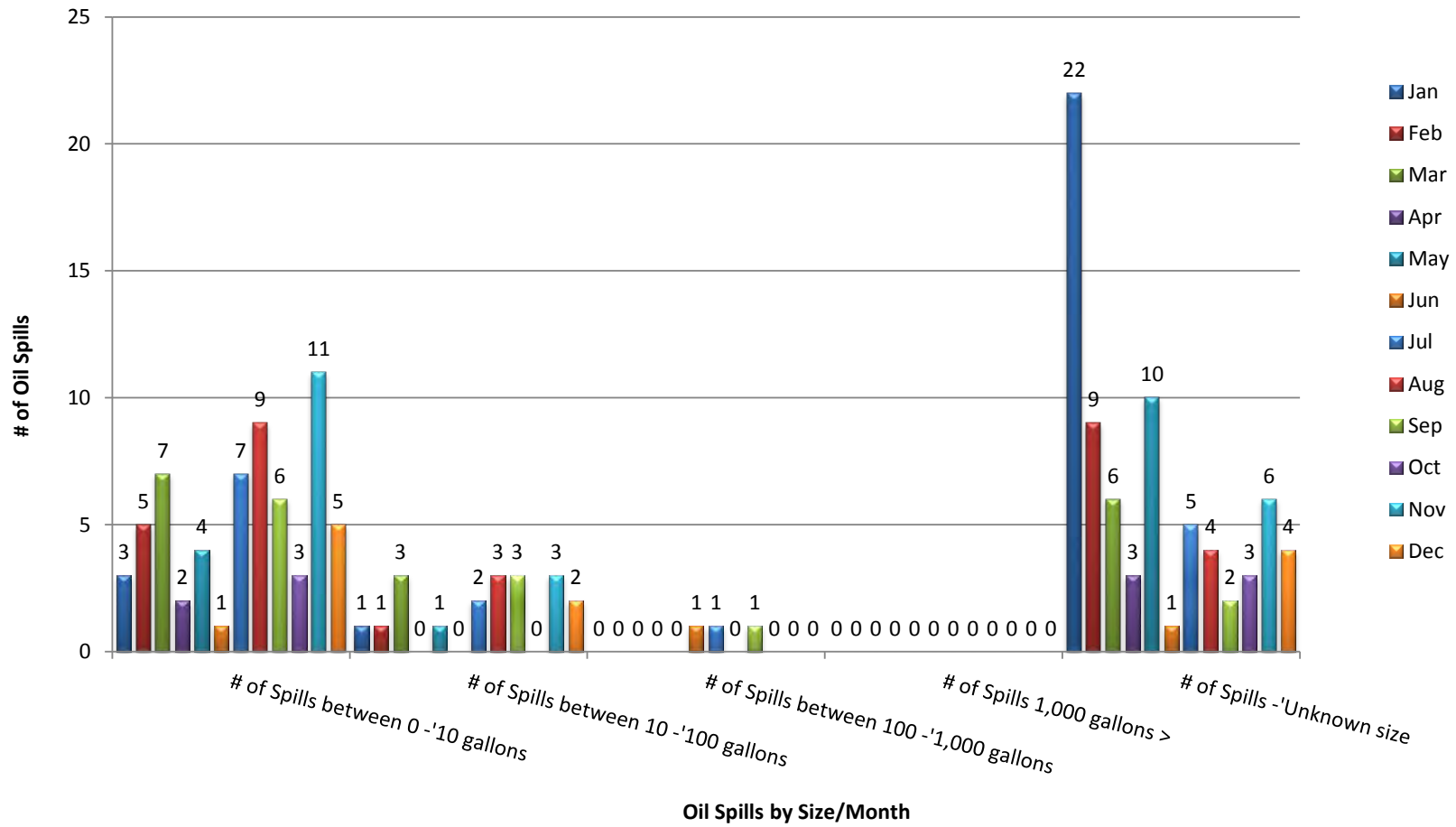

# Appendix L

## Chart 7: Total Reported Oil Spills By Source/Month 2015

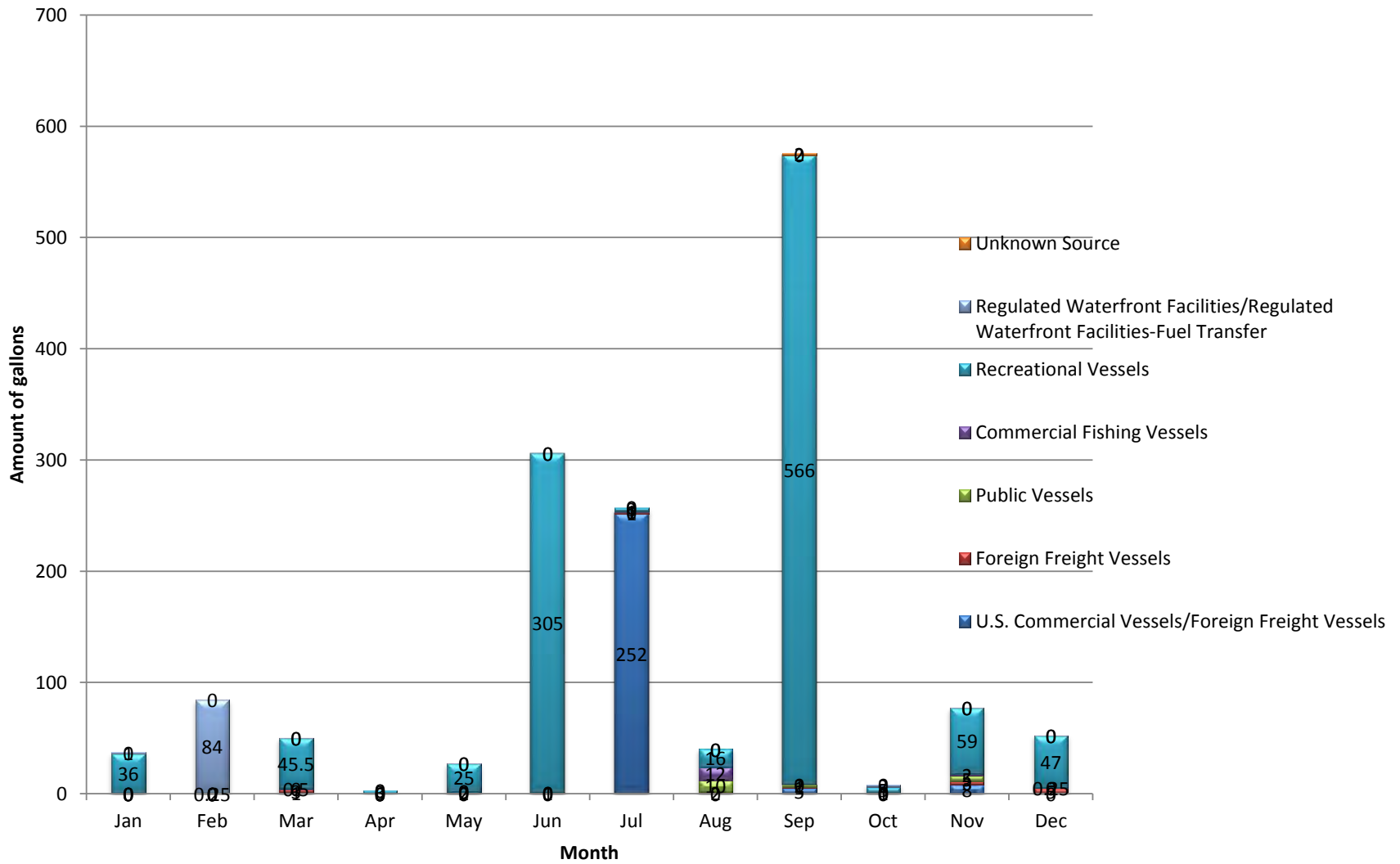

## Appendix M

**CALIFORNIA STATE LANDS COMMISSION  
SAN FRANCISCO REGION  
Waterborne Petroleum Cargo Statistics  
January 1, 2015 – December 31, 2015**

<b>Product</b>	<b>Load (in barrels)</b>	<b>Discharge (in barrels)</b>
Additives - Alkylate	1,240,377	2,177,376
Additives-Denatured Ethanol	184,500	80,000
Additives - Ethanol	804,000	355,000
Additives - Isomerase	49,000	100,000
Additives - Naphtha	2,194,000	256,000
Additives - Other	228,400	0
Additives – Reformate	1,613,000	170,000
Additives – Toulene	0	70,000
Aviation Gasoline	292,400	30,000
Bio-Diesel	4,200	348,000
Crude – ANS	0	30,473,000
Crude- Bakken	0	738,000
Crude – Import	253,000	135,451,713
Crude – Other	210,000	1,772,000
Cutter Stock	41,900	50,000
Decant	44,000	207,000
Diesel	25,044,533	5,676,391
Fuel Oil	19,824,335	6,272,411
Gas-Oil	610,000	50,000
Gasoline	29,602,600	13,771,300
Jet Fuel	6,658,720	2,004,000
Light Cycle Oil	6,266,019	22,745,958
Lube Oil	4,837,000	55,100
MDO	18,000	10
Other	181,500	54,170
Polymer 560	38,400	0
Tetramer	341,800	0
Transmix	1,300	0
<b>Total</b>	<b>100,582,984</b>	<b>222,907,429</b>
	<b>Grand total # of barrels:</b>	<b>323,490,413</b>



## **Appendix N**

### **RECOMMENDATIONS YET TO BE IMPLEMENTED**

**I. Geographical Boundaries** No current recommendation.

**II. General Weather, Tides and Currents**

1. The Harbor Safety Committee supports efforts to adequately fund NOAA maritime functions. The Committee recommends that NOAA update tide and current data using the latest technology available and publish the water level and current atlases on an expeditious basis.

2. The Harbor Safety Committee urges that the OSPR Administrator continue to support PORTS as a high priority and that OSPR continue to seek and allocate funds to maintain the system. The Committee recommends that the Marine Exchange of the San Francisco Bay Region continue to operate, maintain and support the uses of the PORTS program.

3. The Harbor Safety Committee recommends that a statewide uniform system of PORTS, certified by NOAA, be established in California waters. PORTS should be permanently financed by the State of California and/or NOAA, as there is broad public benefit in terms of marine safety, protecting the environment, use by recreational boaters and by academia, and preventing oil spills in California waters. Safety of navigation in our harbors is highly dependent upon real time tidal, current and wind information. OSPR, as an agency, should continue its oversight role.

**III. Aids to Navigation** No current recommendation.

**IV. Anchorages** No current recommendation.

**V. Surveys, Charts and Dredging**

1. The Committee continues to encourage facility owners/operators to conduct annual condition surveys of depths alongside and at the head of their facilities. The surveys should be forwarded to NOAA for application to the nautical charts with a copy to the San Francisco Bar Pilots.

2. The Committee continues to support the spirit of cooperation of the USACE in providing timely up-to-date surveys of deep-water navigation channels, with highest priority on areas where shoaling has taken place, and timely dissemination of that information to the USCG, pilots and the maritime community.

## **Appendix N**

3. The Committee continues to support NOAA's timely updating of charts to reflect survey information from NOAA, USACE and independent sources, frequently publishing data on channel depths in areas heavily trafficked by deep draft vessels, oil tankers and barges, and quickly alerting the USCG, pilots and the maritime community of any changes to charts.

### **VI. Contingency Routing**

1. The Committee continues to support the high degree of cooperation and consultation between pilots, the Coast Guard, the USACE, port authorities and all other appropriate agencies and contractors, from the project planning stage through the construction stage of projects that may impact safe navigation in the Bay. The planning stage should include an evaluation of various alternatives to ensure harbor safety.

2. The Committee continues to request that Caltrans, railroads, etc., provide notice of work that would temporarily or permanently reduce bridge clearances as far in advance as possible through the Local Notice to Mariners, at a minimum, to assure that vessels are alerted to these hazards.

**VII. Vessel Speed and Traffic Patterns** No current recommendation.

**VIII. Accidents and Near-Accidents** No current recommendation.

**IX. Communication** No current recommendation.

### **X. Bridges**

1. The Harbor Safety Committee continues to recommend that Caltrans, the Golden Gate Bridge and other owners and bridge operators install energy-absorbing fendering, instead of wooden or plastic fendering as bridges are repaired, retrofitted or in new construction.

**XI. Small Passenger Vessels – Ferries** No current recommendation.

### **XII. Small Vessels**

The Harbor Safety Committee should facilitate regular communication among parties interested in the potential impacts of fishing, trawling or crabbing to navigation. Forms of communication could include an annual pre-season meeting or other periodic meetings, announcements or mailers to fishermen informing them of spill prevention concerns, or other actions.

## **Appendix N**

2. Representatives of the Harbor Safety Committee should continue to make efforts to meet with representatives of the San Francisco Boardsailing Association, kayak, outrigger and canoe groups to promote safer navigation in the Bay by discussing such issues as race schedules and locations (if applicable); Rules 9 and 5 requirements; characteristics of large vessels, fast ferries, and tug/barge operations, and possible education efforts such as posting signs at areas frequented by large numbers of boardsailors or paddlesports enthusiasts to warn of vessel traffic dangers.

Other possible efforts include:

- Cooperate with the Coast Guard Auxiliary, U.S. Power Squadrons and other educational organizations to emphasize boater safety education and to disseminate boater safety materials to recreational boaters.
- Target boat rental establishments for education of inexperienced boaters.
- Target marinas and boat ramps for education outreach.

**XIII. Vessel Traffic Service** No current recommendation.

**XIV. Tug Escort/Assist for Tank Vessels**

1. The HSC encourages the maritime industry to provide simulator training for tug personnel with pilot participation for emergency tug operations, based on local conditions. The training would improve communication between pilots and tug masters, offer in-house training to tug industry personnel, and provide valuable “lessons learned” for emergency situations in a controlled environment.

**XV. Pilotage** No current recommendation.

**XVI. Underkeel Clearance** No current recommendation.

**XVII. Economic and Environmental Impacts** No current recommendation.

**XVIII. Plan Enforcement** No current recommendation.

**XIX. Substandard Vessel Inspection Program** No current recommendation.

# Map 1

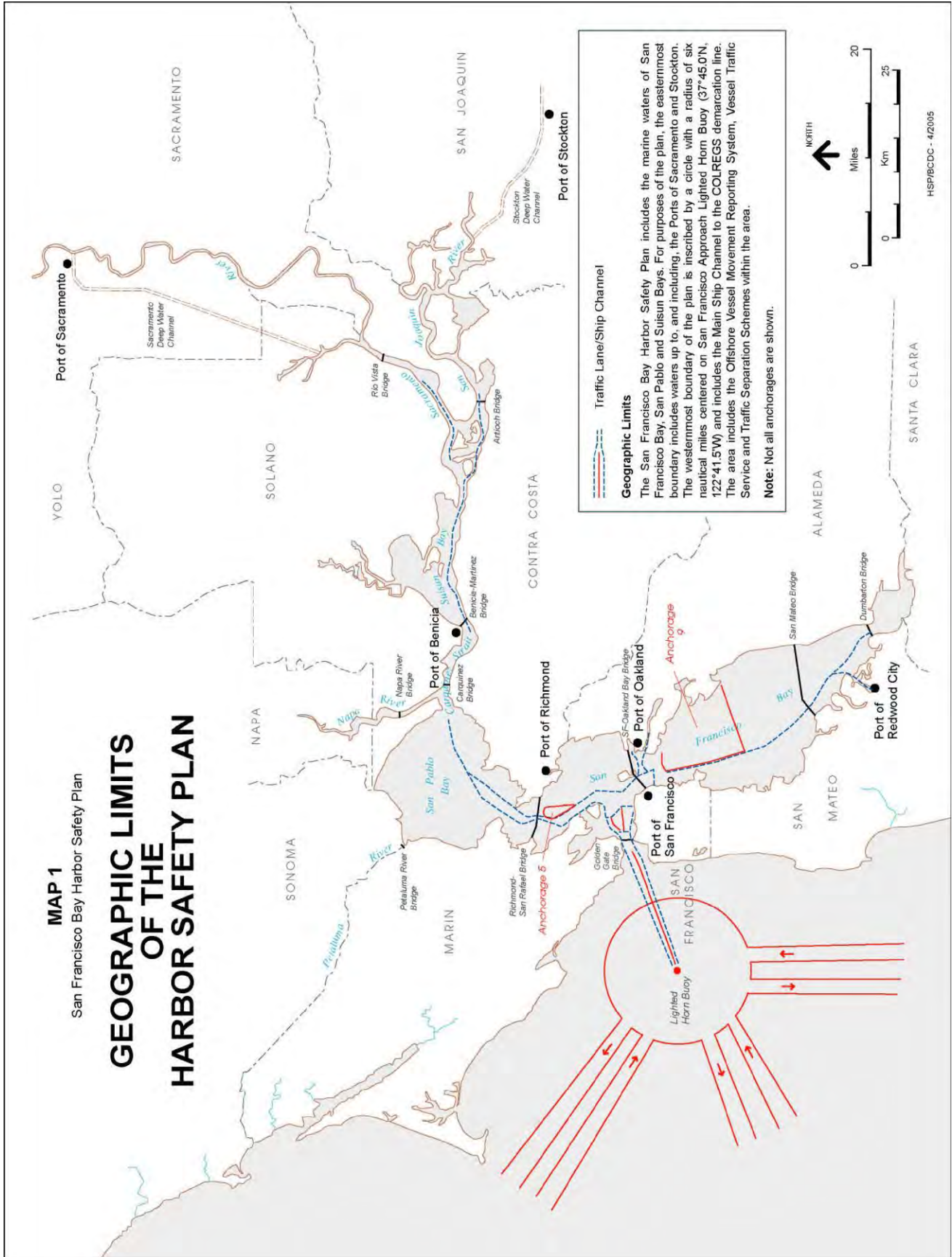

Map 2

